

UNIVERSAL ACCESS PLAN PHASE III – PROGRESSIVE DEVELOPMENT OF A REGIONAL CONCEPT SECONDARY BULK WATER MASTER PLAN FOR THE UGU DISTRICT MUNICIPALITY

CONTRACT NO. 2018/164

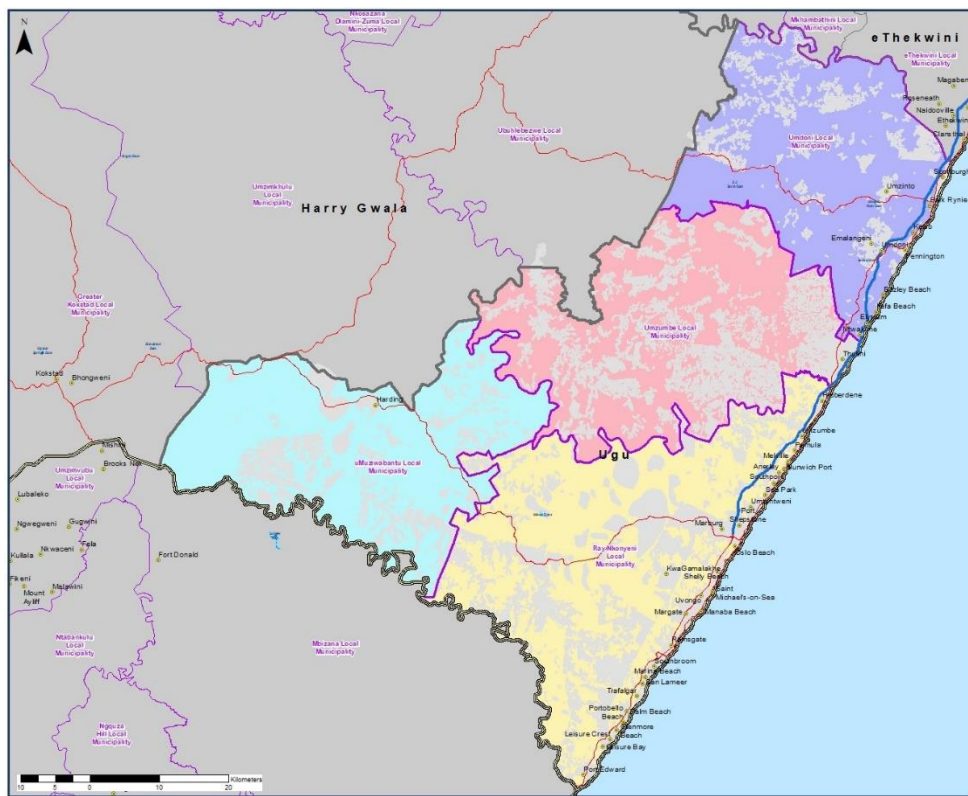

Reconnaissance Report

January 2021

Prepared for:





Name : Umgeni Water
Phone : 033-341 1232 / 082 852 9308
Email : vernon.perumal@umgeni.co.za
Contact Person: Vernon Perumal
Address: 310 Burger Street
Pietermaritzburg
3201

Prepared by:



Name : Mariswe (Pty) Ltd
Phone : +27 (0)12-424-9707
Email : sandram@mariswe.com
Contact Person: Sandra Munnik
Address: P O Box 25549
Monument Park
0181

REPORT / DOCUMENT CONTROL FORM

PROJECT NAME: UNIVERSAL ACCESS PLAN PHASE III – PROGRESSIVE DEVELOPMENT OF A REGIONAL CONCEPT SECONDARY BULK WATER MASTER PLAN FOR THE KWAZULU-NATAL PROVINCE		PROJECT NUMBER: 27814		
REPORT / DOCUMENT TITLE:	UNIVERSAL ACCESS PLAN PHASE III – PROGRESSIVE DEVELOPMENT OF A REGIONAL CONCEPT SECONDARY BULK WATER MASTER PLAN FOR THE UGU DISTRICT MUNICIPALITY			
Document Status:	Draft / Interim / Final: Final Rev. No.: 004	Issue Date: January 2021		
Prepared for:	Client's Name: Umgeni Water	Contact Person: Vernon Perumal Tel No.: 033-341 1232 Email Address: vernon.perumal@umgeni.co.za		
Prepared at / by:	Office:	Division:		
Verification Process:	Name:	Capacity:	Signature:	Date:
Verification by Author:	S Dinanath	Engineer		2021/01/27
Checked by:	R Rajkumar Pr Techni Eng	Project Manager		2021/01/27
Authorised by:	S Munnik	Executive Manager		2021/01/27
Quality Verification: This report / document has been prepared under the quality controls established by Mariswe's Quality Management System, which meets the requirements of the ISO 9001:2015 standard which has been certified by DEKRA Certification under Certificate Number 20907782/5.				



Document Issue Record		
Rev. No.	Description:	Issue Date:
001	Draft Reconciliation Report	June 2020
002	Incorporate comments received from Umgeni Water	September 2020
003	Incorporate comments received from Ugu DM	January 2021
004	Final	January 2021

EXECUTIVE SUMMARY

A. Introduction

Phase III follows on the Phase II study for the Development of a Universal Access Plan (UAP) for Water Supply in the KwaZulu-Natal Province which was completed in June 2016 by various Professional Service Providers (PSP's) that were appointed by Umgeni Water.

The deliverables for UAP Phase II were divided in two phases where Phase 1 included the information review and development of a High Level Status Quo Assessment and Phase 2 included the development of a demand model and needs development plan, culminating in a Reconnaissance Study report for each Water Services Authority (WSA) on bulk water supply. Water Supply Intervention Areas (WSIAs) were identified during UAP Phase II and were based on areas that could be served either by existing schemes or through planned scheme developments (planned projects).

However, the level of detail within the final outcome of UAP Phase II varied between the various PSP's and the magnitude of the cost requirement resulted in Umgeni Water to revisit the process and the need for UAP Phase III was initiated. The main objective of Phase III will be to further develop the conceptual bulk water master plan that would clearly distinguish between primary and secondary bulk.

B. Demographics

The Ugu District Municipality (Ugu) is located in the southern region of the Kwazulu-Natal Province in South Africa. The Ugu DM consists of the following Local Municipalities:

- ✓ Umdoni Local Municipality (KZN212);
- ✓ Umzumbe Local Municipality (KZN213);
- ✓ Umuziwabantu Local Municipality (KZN214); and
- ✓ Ray Nkonyeni Local Municipality (KZN216).

Ugu recorded a total population of 785 792 people within 216 781 households, resulting in an average of 3.62 persons per household.

Table B-1: Ugu Population and Households per Local Municipalities

LM Name	No of Households	No of Population	People per Household
Umdoni	45 272	150 673	3.33
Ray Nkonyeni	95 637	364 413	3.81
Umzumbe	53 415	157 263	2.94
Umuziwabantu	22 457	113 443	5.05
Ugu	216 781	785 792	3.62

Source: DWS Reference Framework, April 2019

Population growth was determined until 2050 that resulted in the projected number of people residing within Ugu will be approximately 1.2 million people. The projected population per Municipality is tabled within Table B-2 below.

Table B-2: Project Population per Local Municipality until 2050

Municipality	DWS RF Pop 2019	Population						
		2020	2025	2030	2035	2040	2045	2050
Umdoni	150 673	122 804	144 977	155 366	167 730	182 072	196 638	232 882
Ray Nkonyeni	364 413	34 421	36 888	39 824	43 229	46 925	50 679	55 292
Umzumbe	157 263	179 508	192 371	207 681	225 438	244 714	264 291	288 350
Umuziwabantu	113 443	367 770	394 125	425 490	461 871	501 362	541 471	590 763
Total	785 792	704 503	768 361	828 361	898 268	975 073	1 053 079	1 167 287

C. Service Levels

C.1 Water

The main source for 33% of households within Ugu is communal stand at a distance below 200m. The Ugu DM exhibits a water backlog of approximately 37%.

C.2 Sanitation

Approximately 36% of households within Ugu use a pit latrine/toilet with a ventilation pipe. The current sanitation backlog within Ugu DM is at approximately 34%.

D. Water Resources

The major rivers within the Ugu DM are the Umzumbe, Ifafa, UMthwalume, UMzumbe, UMtentweni, Umzimkhulu, Umzimkhulwana, Umthamvuna and Mzimayi Rivers. The Ugu DM exhibits bordering rivers, namely, the Umkomaas and Umthamvuna.

Dams within the Ugu DM include the Nungwane Dam, E.J. Smith Dam, Umzinto Dam, Mhlabatshane Dam and the Amanzimnyama (Harding) Dam. Water is also abstracted from boreholes and surface abstraction works.

E. Existing Water Supply Schemes and Water Requirements

The existing water supply schemes within the Ugu DM are as follows:

- ✓ Umgeni Water Supply Scheme;
- ✓ uMzinto Water Supply Scheme;

- ✓ Mtwalume Water Supply Scheme;
- ✓ uMzimkhulu/Bhobhoyi Water Supply Scheme;
- ✓ uMtamvuna Water Supply Scheme;
- ✓ Harding/Weza Water Supply Scheme;
- ✓ KwaFodo Water Supply Scheme;
- ✓ Pungashe/Mhlabatshane Water Supply Scheme;
- ✓ KwaHlongwa/KwaNdelu Water Supply Scheme;
- ✓ Hlokozi/Vulamehlo Water Supply Scheme; and
- ✓ Greater Vulamehlo Water Supply Scheme.

The projected water requirements as per the demand model generated for the Ugu DM up to 2050 amounts to 305.17 Mℓ/d.

Table E-1: Water Requirements (Mℓ/d), Per Local Municipality

LM	2020 Population	2050 Population	2020 (Mℓ/d)	2050 (Mℓ/d)
Umdoni	157 569	253 108	34.84	57.78
Umzumbe	170 140	273 302	30.71	51.30
Ray Nkonyeni	370 334	594 881	91.80	151.59
Umuziwabantu	142 917	229 573	26.61	44.50
Ugu DM	840 960	1 350 864	183.96	305.17

F. Existing Sanitation Supply Schemes

There are twenty (20) sanitation schemes and sixteen (16) wastewater treatment works currently in operation within Ugu DM.

G. Planned and Implementation Projects

The existing regional bulk projects were considered and evaluated to identify potential gaps within the existing project footprints to the extent that a total “wall-to-wall” bulk water services needs perspective is visualised and realised. This was done in the context to improve access to basic services but at the same time support economic growth and development and ensure sustainable services.

The funding streams available for infrastructure development over the next three years within Ugu amount to approximately R944 452 000.

H. Bulk Water Supply Interventions Considered

This study aims to ensure that the Ugu can make provision for and plan to supply all consumers within its area of jurisdiction with at least basic water supply services. Not all consumers are currently supplied with formal schemes and part of the objectives of this study were to determine where these consumers are, what their water requirements are and the options that could be considered to ensure universal access to water supply up to 2050

Water Supply Intervention Areas (WSIA's) were identified during this process based on areas that can be served either by linkage to existing schemes or through planned scheme developments (planned projects). These WSIA's, number of applicable households, population and their water requirements are illustrated within **Table H-1**.

Table H-1 Conceptual Scheme Areas, Households and Water Requirements

WSIA No	WSIA Name	Population 2020	Population 2050	Water Demand 2020 (Mℓ/day)	Water Demand 2050 (Mℓ/day)
UG001	uMzinto	67 413	108 288	19.14	31.47
UG002	uMtwalume	76 528	122 929	14.14	23.59
UG003	uMzimkhulu/Bhobhoyi	221 650	356 045	63.07	103.58
UG004	Umtamvuna	134 978	216 820	26.16	43.72
UG005	Harding/Weza	18 305	29 405	3.14	5.26
UG006	KwaFodo	9 368	15 048	1.64	2.76
UG007	KwaLembe	16 814	27 009	2.93	4.92
UG008	Phungashe/Mahlabatshane	64 642	103 836	10.95	18.32
UG009	KwaHlongwa	6 953	11 169	1.20	2.01
UG010	Vulamehlo Farming	12 592	20 227	2.13	3.26
UG011	Vulamehlo Scheme	7 110	11 421	1.19	1.99
UG012	Vulamehlo Cross Border	51 554	82 813	9.02	15.12
UG013	KwaMbotho	16 115	25 887	2.84	4.77
UG014	KwaNyuswa	11 142	17 898	1.93	3.24
UG015	KwaNdelu	14 907	23 946	2.50	3.80
Ugu DM		730 071	1 172 741	161.98	267.81

The uMzimkhulu/Bhobhoyi WSIA and the uMtwalume WSIA has the highest water demand of approximately 39% and 16% respectively. These WSIA's are also the biggest two (2) supply areas within the Ugu DM and would be serving close to 55% of the Ugu population.

The total volume of water required is compared to the existing proposed water supply interventions and tabled within **Table H2** below:

Table H2: Water Resources Required vs proposed WSI

WSIA	WSIA Name	Population (2050)	2050 Demand (Mℓ/day)	2050 Demand (Mm ³ /a)	Existing Resources (Mm ³ /a)	Proposed Additional under UAP Phase 3 (Mm ³ /a)	Total (Mm ³ /a)	Balance (Mm ³ /a)
UG001	uMzinto	108 288	31.47	11.49	6.64	-6.64	0.00	-11.49
UG002	uMtwalume	122 929	23.59	8.61	2.74	-2.74	0.00	-8.61
UG003	uMzimkhulu/Bhobhoyi	356 045	103.58	37.81	39.42	0.00	39.42	1.61
UG004	Umtamvuna	216 820	43.72	15.96	18.25	0.00	18.25	2.29
UG005	Harding/Weza	29 405	5.26	1.92	1.31	16.06	17.37	15.45
UG006	KwaFodo	15 048	2.76	1.01	0.00	0.00	0.00	-1.01
UG007	KwaLembe	27 009	4.92	1.80	2.19	0.00	2.19	0.39
UG008	Phungashe/Mahlabatshane	103 836	18.32	6.69	5.99	0.70	6.69	0.00
UG009	KwaHlongwa	11 169	2.01	0.73	0.00	0.00	0.00	-0.73
UG010	Vulamehlo Farming	20 227	3.26	1.19	0.00	2.28	2.28	1.10
UG011	Vulamehlo Scheme	11 421	1.99	0.73	0.51	-0.51	0.00	-0.73
UG012	Vulamehlo Cross Border	82 813	15.12	5.52	3.72	-3.72	0.00	-5.52
UG013	KwaMbotho	25 887	4.77	1.74	0.51	-0.51	0.00	-1.74
UG014	KwaNyuswa	17 898	3.24	1.18	0.09	-0.09	0.00	-1.18
UG015	KwaNdelu	23 946	3.8	1.39	0.51	-0.51	0.00	-1.39
TOTAL		1 172 741	267.81	97.75	81.89	4.32	86.21	-11.54

From the table above, it is noted all the schemes will not have adequate raw water resources after upgrades/interventions to meet the 2050 demand requirements. The feasibility studies for the proposed resources and, in addition, the implementation of the uMzimkhulu/Bhobhoyi Water Supply Scheme should be prioritised.

A total estimate of approximately R 6.4 billion is required to address the total bulk water supply requirement by 2050. The total cost requirement per WSIA is tabled within **Table H-3**.

H-3: Total Cost requirement

WSIA	WSIA Name	Total Cost Requirement				
		Primary	Secondary	Tertiary	10% Contingencies	Total Cost (excl VAT)
UG001	uMzinto	R74 382 331.82	R213 917 368.96	R19 638 037.19	R30 793 773.80	R338 731 511.76
UG002	uMtwalume	R11 068 218.66	R59 462 400.53	R25 004 042.22	R9 553 466.14	R105 088 127.55
UG003	uMzimkhulu/Bhobhoyi	R498 184 221.00	R73 554 946.79	R4 070 593.57	R57 580 976.14	R633 390 737.50
UG004	uMtamvuna	R152 111 998.58	R165 757 765.44	R34 401 229.91	R35 227 099.39	R387 498 093.32
UG005	Harding/Weza	R2 493 761 308.23	R236 932 425.60	R60 025 541.15	R279 071 927.50	R3 069 791 202.48
UG006	KwaFodo	-	R26 845 264.36	R3 201 297.91	R3 004 656.23	R33 051 218.49
UG007	KwaLembe	R18 483 000.00	R74 338 542.28	R17 194 560.77	R11 001 610.30	R121 017 713.35
UG008	Phungashe/Mahlabatshane	-	R78 947 429.82	R28 551 674.82	R10 749 910.46	R118 249 015.10
UG009	KwaHlongwa	-	R29 328 863.99	R4 597 878.01	R3 392 674.20	R37 319 416.19
UG010	Vulamehlo Farming	-	R26 579 465.75	R10 077 160.05	R3 665 662.58	R40 322 288.39
UG011	Vulamehlo Scheme	-	R16 786 394.92	R2 895 175.76	R1 968 157.07	R21 649 727.75
UG012	Vulamehlo Cross Border	R915 479 269.49	R199 328 659.08	R53 219 704.65	R116 802 763.32	R1 284 830 396.53
UG013	KwaMbotho	-	R60 009 428.16	R16 475 957.33	R7 648 538.55	R84 133 924.04
UG014	KwaNyuswa	-	R46 634 124.29	R20 965 950.07	R6 760 007.44	R74 360 081.79
UG015	KwaNdelu	-	R28 189 697.29	R17 179 811.03	R4 536 950.83	R49 906 459.15
Total		R4 163 470 347.78	R1 336 612 777.26	R317 498 614.44	R581 758 173.95	R6 399 339 913.39

I. Conclusions and Recommendations.

The Ugu DM still faces a backlog in water supply – not only in providing all consumers within its area of jurisdiction with access to water supply according to its WSA duties, but also in ensuring sustainable water services of existing supply. Furthermore, there are areas where the existing water supply infrastructure as well as water source, are insufficient to meet current and projected future water requirements. New developments and urbanisation put further strain on existing supplies and resources.

The Ugu DM relies mainly on grant funding programmes to fund their water supply projects. These funding programmes are mainly MIG and WSIG. Based on all the current funding streams available to the District Municipality over the MTEF period, it will take a minimum of fifteen years for the Ugu DM to address their bulk water supply requirements.

The implementation programme will depend on the availability of funds from National Treasury as well as the capacity of the Municipality to implement projects. All twenty-one area interventions would be an implementation priority for the DM but the order would most likely be determined by the availability of funds or intervention programmes.

The provision of water services remains the responsibility of the Ugu DM as the WSA. The Ugu DM should ensure that they meet all the requirements to take these interventions to implementation readiness. These planning studies are in various stages of readiness to lobby for grant funding and Umgeni Water could consider as a Regional Utility to assist the Ugu DM to take this process further.

The fifteen (15) proposed water supply intervention areas (WSIAs) are the appropriate solutions for bulk water supply development within Ugu and are as follows:

- ✓ UG001 WSIA: uMzinto;
- ✓ UG002 WSIA: uMtwalume;
- ✓ UG003 WSIA: uMzimkhulu/Bhobhoyi;
- ✓ UG004 WSIA: uMtamvuna;
- ✓ UG005 WSIA: Harding/Weza;
- ✓ UG006 WSIA: KwaFodo;
- ✓ UG007 WSIA: KwaLembe;
- ✓ UG008 WSIA: Phungashe/Mahlabatshane;
- ✓ UG009 WSIA: KwaHlongwa;
- ✓ UG010 WSIA: Vulamehlo Farming;
- ✓ UG011 WSIA: Vulamehlo Scheme;
- ✓ UG012 WSIA: Vulamehlo Cross Border;
- ✓ UG013 WSIA: KwaMbotho;
- ✓ UG014 WSIA: KwaNyuswa; and
- ✓ UG015 WSIA: KwaNdelu.

The implementation programme will depend on the availability of funds from National Treasury as well as the capacity of the Municipality to implement projects. Although all fifteen (15) area interventions would be an implementation priority for the DM, it is proposed to consider the following three (3) priorities detailed within **Table I-1**. It is also proposed to follow a phased approach for implementation for e.g. initiate only the upgrade to the WTP at first and then when funding permits, can the bulk conveyance and storage be extended, upgraded or constructed.

However, the order would most likely be determined by the availability of funds or intervention programmes and should be confirmed with the WSA.

I-1: Proposed Implementation Order (Phased Approach)

Proposed Priorities (Phased Approach)	WSIA No and Name	Proposed Project Name	Proposed Estimated Project Value	
1	UG003 UG008	uMzimkhulu/Bhobhoyi Phungashe/Mahlabatshane	Development of Ncwabeni OCS Dam in order to assure supply to uMzimkhulu/Bhobhoyi as well as supply to Phungashe/Mahlabatshane. Implementation of weir on Mzimkhulu River to address salination and supply.	R633 390 737.50
2	UG004	uMtamvuna	Upgrade of supply to Southbroom to augment the uMzimkhulu/Bhobhoyi scheme .	R118 249 015.10
3	UG005	Harding/Weza	Hydrological study for the Gundrift weir to determine yield to supply the Harding/Weza scheme.	R387 498 093.32
4	UG012	Vulamehlo Cross Border	Feasibility study to increase the yield of Vulamehlo Dam to assure of supply to the Vulamehlo and uMtwalume/uMzinto schemes.	R3 069 791 202.48
5	UG002	uMtwalume	Further supply from the South Coast Pipeline. Hydrological study on the Mtwalume River/weir to determine yield to supply the uMtamvuna scheme.	R1 284 830 396.53

Table of Contents

1.	OBJECTIVES AND METHODOLOGY	81
1.1	Background and Introduction	81
1.2	Purpose of the Report	82
1.3	Information Sources	82
1.4	Stakeholder Engagement	83
1.5	Water Requirements Model Methodology.....	83
1.5.1	<i>Total Water Demand Calculations</i>	<i>84</i>
1.6	DWS Reference Framework Geodatabase.....	88
1.7	Reconnaissance Report	89
2.	STUDY AREA	90
2.1	Context	90
2.2	Physical Characteristics of the Study Area.....	92
2.2.1	<i>Umdoni Local Municipality</i>	<i>92</i>
2.2.2	<i>Ray Nkonyeni Local Municipality</i>	<i>92</i>
2.2.3	<i>Umzumbe Local Municipality.....</i>	<i>93</i>
2.2.4	<i>Umuziwabantu Local Municipality.....</i>	<i>93</i>
2.3	Climate and Climate Change.....	94
2.4	Topography, Geology and Soils.....	95
2.5	Environmental.....	96
2.6	Institutional Arrangements for Water Supply.....	98
3.	DEMOGRAPHICS.....	99
3.1	Existing Population Distribution.....	99
3.2	Social and Economic Indicators.....	101
3.3	Population Growth Scenarios	106
3.4	Main Development Nodes.....	107
4.	WATER REQUIREMENTS.....	108
4.1	Water Supply Service Level.....	108
4.2	Water Losses and Demand Management.....	111
4.3	Water Balance.....	112

4.4	Water Demand Model.....	113
4.4.1	Water Demand for Ugu District Municipality	113
4.4.2	Demand per Regional Water Scheme.....	114
5.	EXISTING WATER SUPPLY INFRASTRUCTURE	116
5.1	Water Resource Availability.....	116
5.1.1	Surface Water.....	116
5.2	Physical Infrastructure.....	122
5.2.1	Umgeni Water Supply Scheme.....	124
5.2.2	uMzinto Water Supply Scheme	125
5.2.3	Mtwalume Water Supply Scheme	126
5.2.4	uMzimkhulu/Bhobhoyi Water Supply Scheme	126
5.2.5	uMtamvuna Water Supply Scheme.....	128
5.2.6	Harding/Weza Water Supply Scheme	128
5.2.7	KwaMbotho Water Supply Scheme.....	129
5.2.8	KwaFodo Water Supply Scheme.....	130
5.2.9	KwaNywasa Water Supply Scheme.....	131
5.2.10	Pungashe/Mhlabatshane Water Supply Scheme	132
5.2.11	KwaNdelu Water Supply Scheme	133
5.2.12	Vulamehlo Water Supply Scheme	134
5.2.13	KwaHlongwa Water Supply Scheme.....	134
5.2.14	Vulamehlo Cross Border Water Supply Scheme	135
5.2.15	Vulamehlo Farming Water Supply Scheme.....	137
5.2.16	KwaLembe Water Supply Scheme	137
6.	EXISTING SANITATION BULK INFRASTRUCTURE	143
6.1	Sanitation Service Level.....	143
6.2	Existing Sanitation Bulk Infrastructure	144
7.	BULK WATER SUPPLY PROJECTS CURRENTLY IN PLANNING	149
7.1	Regional Bulk Water Projects in Planning.....	150
8.	SYNOPSIS OF EXISTING AND COMMITTED SCHEMES.....	152
8.1	UG001 WSIA: Umzinto Scheme	153

8.2	UG002 WSIA: Mtwalume Water Supply Scheme	153
8.3	UG003 WSIA: Mzikhulu/Bhobhoyi Scheme	154
8.4	UG004 WSIA: Umtamvuna Scheme	155
8.5	UG005 WSIA: Harding/Weza Scheme	156
8.6	UG006 WSIA: KwaFodo Scheme	156
8.7	UG007 WSIA: KwaLembe Scheme.....	157
8.8	UG008 WSIA: Pungashe/Mhlabatshane Scheme	158
8.9	UG009 WSIA: KwaHlongwa Scheme.....	158
8.10	UG010 WSIA: Vulamehlo Farming Scheme.....	159
8.11	UG011 WSIA: Vulamehlo Scheme	159
8.12	UG012 WSIA: Greater Vulamehlo Cross Border Scheme.....	160
8.13	UG013 WSIA: kwaMbotho Scheme.....	161
8.14	UG014 WSIA: kwaNyuswa Scheme	161
8.15	UG015 WSIA: KwaNdelu Scheme	162
9.	PROPOSED BULK WATER SUPPLY INTERVENTIONS	163
9.1	UG001 WSIA: uMzinto Scheme.....	165
9.1.1	<i>Demand Model Intervention.....</i>	<i>165</i>
9.1.2	<i>Water Supply Infrastructure</i>	<i>165</i>
9.2	UG002 WSIA: uMtwalume Water Supply Scheme	168
9.2.1	<i>Demand Model Intervention.....</i>	<i>168</i>
9.2.2	<i>Water Supply Infrastructure</i>	<i>168</i>
9.2.3	<i>Financial Requirements</i>	<i>170</i>
9.3	UG003 WSIA: uMzikhulu/Bhobhoyi Scheme	173
9.3.1	<i>Demand Model Intervention.....</i>	<i>173</i>
9.3.2	<i>Water Supply Infrastructure</i>	<i>173</i>
9.3.3	<i>Financial Requirements</i>	<i>175</i>
9.4	UG004 WSIA: Umtamvuna Water Supply Scheme.....	178
9.4.1	<i>Demand Model Intervention.....</i>	<i>178</i>
9.4.2	<i>Water Supply Infrastructure</i>	<i>178</i>
9.4.3	<i>Financial Requirements</i>	<i>180</i>
9.5	UG005 WSIA: Harding/Weza Water Supply Scheme.....	183
9.5.1	<i>Demand Model Intervention.....</i>	<i>183</i>

9.5.2	Water Supply Infrastructure	184
9.5.3	Financial Requirements	185
9.6	UG006 WSIA: KwaFodo Water Supply Scheme.....	188
9.6.1	Demand Model Intervention.....	188
9.6.2	Water Supply Infrastructure	188
9.6.3	Financial Requirements	189
9.7	UG007 WSIA: Kwalembe Water Supply Scheme.....	192
9.7.1	Demand Model Intervention.....	192
9.7.2	Water Supply Infrastructure	192
9.7.3	Financial Requirements	193
9.8	UG008 WSIA: Phungashe/Mhlabatshane Water Supply Scheme	196
9.8.1	Demand Model Intervention.....	196
9.8.2	Water Supply Infrastructure	196
9.8.3	Financial Requirements	197
9.9	UG009 WSIA: KwaHlongwa Water Supply Scheme	201
9.9.1	Demand Model Intervention.....	201
9.9.2	Water Supply Infrastructure	201
9.9.3	Financial Requirements	202
9.10	UG010 WSIA: Vulamehlo Farming Scheme.....	205
9.10.1	Demand Model Intervention.....	205
9.10.2	Water Supply Infrastructure	205
9.10.3	Financial Requirements	206
9.11	UG011 WSIA: Vulamehlo Water Supply Scheme	209
9.11.1	Demand Model Intervention.....	209
9.11.2	Water Supply Infrastructure	209
9.11.3	Financial Requirements	210
9.12	UG012 WSIA: Vulamehlo Cross Border Water Supply Scheme	213
9.12.1	Demand Model Intervention.....	213
9.12.2	Water Supply Infrastructure	213
9.12.3	Financial Requirements	215
9.13	UG013 WSIA: KwaMbotho Water Supply Scheme	218
9.13.1	Demand Model Intervention.....	218
9.13.2	Water Supply Infrastructure	218

9.13.3	Financial Requirements	219
9.14	UG014 WSIA: KwaNyuswa Water Supply Scheme	222
9.14.1	Demand Model Intervention.....	222
9.14.2	Water Supply Infrastructure	222
9.14.3	Financial Requirements	223
9.15	UG015 WSIA: KwaNdelu water Supply Scheme	226
9.15.1	Demand Model Intervention.....	226
9.15.2	Water Supply Infrastructure	226
9.15.3	Financial Requirements	227
10.	CONCLUSIONS	230
10.1	Total Water Demand per Water Supply Intervention Area (WSIA).....	230
10.2	Total Water Resources Required vs Proposed Water Supply Interventions (WSI)	231
10.3	Summary of Total Bulk Water Infrastructure Requirements per WSIA	231
10.3.1	UG001: uMzinto WSIA.....	232
10.3.2	UG002 WSIA: uMtwalume WSIA.....	233
10.3.3	UG003 WSIA: uMzimkhulu/Bhobhoyi WSIA.....	234
10.3.4	UG004 WSIA: uMtamvuna WSIA.....	235
10.3.5	UG005 WSIA: Harding/Weza WSIA	236
10.3.6	UG006 WSIA: KwaFodo WSIA	237
10.3.7	UG007 WSIA: KwaLembe WSIA.....	238
10.3.8	UG008 WSIA: Phungashe/Mahlabatshane WSIA.....	239
10.3.9	UG009 WSIA: KwaHlongwa WSIA	240
10.3.10	UG010 WSIA: Vulamehlo Farming WSIA	241
10.3.11	UG011 WSIA: Vulamehlo Scheme WSIA	242
10.3.12	UG012 WSIA: Vulamehlo Cross Border WSIA.....	243
10.3.13	UG013 WSIA: KwaMbotho WSIA.....	244
10.3.14	UG014 WSIA: KwaNyuswa WSIA.....	245
10.3.15	UG015 WSIA: KwaNdelu WSIA.....	246
10.4	Financial Requirements	247
10.5	Funding Options.....	247
10.6	Implementation Programme	248
11.	RECOMMENDATIONS.....	249

11.1	Responsibilities	249
11.2	Selection of Solutions	249
11.3	Pertinent Legislation	249
11.3.1	<i>Municipal Structures Act</i>	250
11.3.2	<i>Municipal Systems Act</i>	250
11.3.3	<i>Water Services Act</i>	250
ANNEXURE A – REFERENCES.....		252
ANNEXURE B – DETAILED PROPOSED WSI INFRASTRUCTURE COMPONENT DETAIL		253

List of Tables

Table 1-1: Assumed average AADD per person per combined income and LoS category.....	86
Table 1-2 Indirect demands, as a ratio of direct demands per Centre classification	87
Table 1-3 Level of Service Upgrade.....	88
Table 3-1: Population & Household Figures for Ugu DM.....	99
Table 3-2: Population and Growth Rate: 2011 – 2016	99
Table 3-3: Ugu Gross Value-Added Contribution.....	103
Table 3-4: Sectoral share of GVA at current basic prices per LM within Ugu DM, 2015	104
Table 3-5: Sectoral share of employment, 2005 and 2015.....	105
Table 3-6: Sectoral share of employment per LM within Ugu DM, 2015	105
Table 3-7: Contribution of LMs to sectoral employment, 2015	106
Table 4-1: Water Backlogs within Ugu District Municipality.....	108
Table 4-2: Distribution of households by main source of water for drinking, DWS RF 2019.....	109
Table 4-3: Ugu DM Water Balance, December 2018.....	112
Table 4-4: Water Requirements (Mℓ/d), per Local Municipality	113
Table 4-5: Ugu DM Water supply scheme demands	114
Table 5-1: Yield Information for the existing water resource developments in the Mℓazi/Lovu Region	118
Table 5-2: Yields for the proposed Lower uMkhomazi BWSS (Ngwadini Dam)	118
Table 5-3: Yield Information for the existing water resource infrastructure in the Middle South Coast Region.....	119
Table 5-4: Yield Information for the St Helen’s Rock Abstraction site (Mzimkulu Region).....	119
Table 5-5: Major Water Infrastructure.....	122
Table 5-6: Bulk Water Infrastructure (uMzinto WSS).....	125
Table 5-7: Bulk Water Infrastructure (Mtwalume WSS).....	126
Table 5-8: Bulk Water Infrastructure (uMzimkhulu/Bhobhoyi WSS)	127
Table 5-9: Bulk Water Infrastructure (uMtamvuna WSS).....	128
Table 5-10: Bulk Water Infrastructure (Harding/Weza WSS)	129
Table 5-11: Bulk Water Infrastructure (kwaMbotho WSS).....	130
Table 5-12: Bulk Water Infrastructure (kwaFodo WSS).....	131
Table 5-13: Bulk Water Infrastructure (kwaNyuswa WSS)	132
Table 5-14: Bulk Water Infrastructure (Pungashe/Mhlabatshane WSS)	133
Table 5-15: Bulk Water Infrastructure (kwaNdelu WSS)	134
Table 5-16: Bulk Water Infrastructure (kwaHlongwa WSS).....	135

Table 5-17: Bulk Water Infrastructure (Vulamehlo Cross Border WSS)	136
Table 5-18: Bulk Water Infrastructure (kwaLembe WSS)	137
Table 6-1: Distribution of households by type of toilet facility, DWS RF 2019	143
Table 6-2: Sanitation Backlogs within Ugu District Municipality.....	144
Table 6-3: List of Wastewater Treatment Plants.....	146
Table 8-1: Grant Funding Streams	150
Table 8-2: Three-Year Medium-Term Expenditure Framework (MTEF) per Local Municipality in Ugu DM	150
Table 8-3: Umgeni Water Projects for Ugu DM (2019).....	150
Table 8-1: uMzinto Scheme Gap Analysis.....	153
Table 8-2: Mtwalume Scheme Gap Analysis.....	154
Table 8-3: uMzimkhulu/Bhobhoyi Scheme Gap Analysis	155
Table 8-4: Umtamvuna Scheme Gap Analysis	155
Table 8-5: Harding/Weza Scheme Gap Analysis	156
Table 8-6: kwaFodo Scheme Gap Analysis	157
Table 8-7: KwaLembe Scheme Gap Analysis	157
Table 8-8: Scheme Gap Analysis	158
Table 8-9: kwaHlongwa Scheme Gap Analysis.....	159
Table 8-10: Vulamehlo Farming Scheme Gap Analysis	159
Table 8-11: Vulamehlo Scheme Gap Analysis.....	160
Table 8-12: Greater Vulamehlo Cross Border Scheme Gap Analysis.....	160
Table 8-13: KwaMbotho Scheme Gap Analysis.....	161
Table 8-14: KwaNyuswa Scheme Gap Analysis.....	162
Table 8-15: Ndelu Scheme Gap Analysis	162
Table 9-1: Population and Water demand 2020 and 2050 for the Umzinto Scheme Area	165
Table 9-2: Population and Water demand 2020 and 2050 for uMtwalume WSIA	168
Table 9-3: UG002 uMtwalume Scheme Cost Requirement.....	170
Table 9-4: Population and Water demand 2020 and 2050 for the uMzimkhulu/Bhobhoyi WSIA	173
Table 9-5: UG003 uMzimkhulu/Bhobhoyi Scheme Cost Requirement	175
Table 9-6: Population and Water demand 2020 and 2050 for the uMtamvuna Scheme.....	178
Table 9-7: UG004 uMtamvuna Scheme Cost Requirement.....	180
Table 9-8: Population and Water demand 2020 and 2050 for the Harding/Weza BWSS.....	183
Table 9-9: UG005 Harding/Weza Scheme Cost Requirement	185
Table 9-10: Population and Water demand 2020 and 2050 for the KwaFodo Scheme	188

Table 9-11: UG006 kwaFodo Scheme Cost Requirement.....	189
Table 9-12: Population and Water demand 2020 and 2050 for the Kwalembe Scheme	192
Table 9-13: UG007 kwaLembe Scheme Cost Requirement	193
Table 9-14: Population and Water demand 2020 and 2050 for the Phungashe/Mahlabatshane WSIA.....	196
Table 9-15: UG008 Phungashe/Mhlabatshane Scheme Cost Requirement	198
Table 9-16: Population and Water demand 2020 and 2050 for the KwaHlongwa Scheme	201
Table 9-17: UG009 KwaHlongwa Scheme Cost Requirement.....	202
Table 9-18: Population and Water demand 2020 and 2050 for the Vulamehlo Farming WSIA	205
Table 9-19: UG010 Vulamehlo Farming Scheme Cost Requirement.....	206
Table 9-20: Population and Water demand 2020 and 2050 for the Vulamehlo WSIA.....	209
Table 9-21: UG011 Vulamehlo Scheme Cost Requirement	210
Table 9-22: Population and Water demand 2020 and 2050 for the Vulamehlo Cross Border Scheme Area	213
Table 9-23: UG012 Vulamehlo Cross Border Scheme Cost Requirement.....	215
Table 9-24: Population and Water demand 2020 and 2050 for the kwaMbotho WSS.....	218
Table 9-25: UG013 KwaMbotho Scheme Cost Requirement.....	219
Table 9-26: Population and Water demand 2020 and 2050 for KwaNyuswa WSIA.....	222
Table 9-27: UG014 KwaNyuswa Scheme Cost Requirement	223
Table 9-28: Population and Water demand 2020 and 2050 for the KwaNdelu WSIA.....	226
Table 9-29: UG015 KwaNdelu Scheme Cost Requirement	227
Table 10-1: Total Water Demand 2050 per WSIA.....	230
Table 10-2: Water Resources Required vs proposed WSI	231
Table 10-3: WSIA Summary for the UG001: uMzinto WSIA	232
Table 10-4: WSIA Summary for the UG002 WSIA: uMtwalume WSIA	233
Table 10-5: WSIA Summary for the UG003 WSIA: uMzimkhulu/Bhobhoyi WSIA.....	234
Table 10-6: WSIA Summary for the UG004 WSIA: uMtamvuna WSIA	235
Table 10-7: WSIA Summary for the UG005 WSIA: Harding/Weza WSIA	236
Table 10-8: WSIA Summary for the UG006 WSIA: KwaFodo WSIA	237
Table 10-9: WSIA Summary for the UG007 WSIA: KwaLembe WSIA	238
Table 10-10: WSIA Summary for the UG008 WSIA: Phungashe/Mahlabatshane WSIA.....	239
Table 10-11: WSIA Summary for the UG009 WSIA: KwaHlongwa WSIA	240
Table 10-12: WSIA Summary for the UG010 WSIA: Vulamehlo Farming WSIA	241
Table 10-13: WSIA Summary for the UG011 WSIA: Vulamehlo Scheme WSIA.....	242
Table 10-14: WSIA Summary for the UG012 WSIA: Vulamehlo Cross Border WSIA	243

Table 10-15: WSIA Summary for the UG013 WSIA: KwaMbotho WSIA	244
Table 10-16: WSIA Summary for the UG014 WSIA: KwaNyuswa WSIA.....	245
Table 10-17: WSIA Summary for the UG015 WSIA: KwaNdelu WSIA.....	246
Table 10-18: Financial requirements.....	247
Table 10-19: Proposed Implementation Order (Phased Approach).....	248

List of Figures

Figure 2-1: Study Area.....	91
Figure 3-1: Population distribution.....	100
Figure 4-1: Water supply reliability profile.....	110
Figure 4-2: 2050 Water Demand in Mℓ/day per LM.....	114
Figure 5-1: Ugu DM Water Resources.....	121
Figure 5-2: Ugu Bulk Water Supply Areas as per DWS.....	123
Figure 5-3: Ugu Bulk Water Supply Areas as per UAP Phase II.....	124
Figure 5-4: Existing Infrastructure – Ugu DM.....	138
Figure 5-5: Existing Infrastructure – Umdoni LM.....	139
Figure 5-6: Existing Infrastructure – Umzumbe LM.....	140
Figure 5-7: Existing Infrastructure – Umuziwabantu LM.....	141
Figure 5-8: Existing Infrastructure – Ray Nkonyeni LM.....	142
Figure 6-1: Sanitation reliability profile.....	147
Figure 6-2: Existing sanitation infrastructure.....	148
Figure 9-1: Overall Ugu Proposed Bulk WSIA's.....	164
Figure 9-2: UG001 uMzinto WSIA.....	166
Figure 9-3: Schematic layout of UG001: uMzinto Scheme.....	167
Figure 9-4: UG002 Mtwalume WSIA.....	171
Figure 9-5: Schematic layout of UG002: Mtwalume Scheme.....	172
Figure 9-6: UG003 uMzimkhulu/Bhobhoyi WSIA.....	176
Figure 9-7: Schematic layout of UG003: uMzimkhulu/Bhobhoyi Scheme.....	177
Figure 9-8: UG004 uMtamvuna WSIA.....	181
Figure 9-9: Schematic layout of UG004: uMtamvuna Scheme.....	182
Figure 9-10: UG005 Harding/Weza WSIA.....	186
Figure 9-11: Schematic layout of UG005: Harding/Weza Scheme.....	187
Figure 9-12: UG006 KwaFodo WSIA.....	190
Figure 9-13: Schematic layout of UG006: KwaFodo Scheme.....	191
Figure 9-14: UG007 KwaLembe WSIA.....	194
Figure 9-15: Schematic layout of UG007 Kwalembe Scheme.....	195
Figure 9-16: UG008 Pungashe/Mhlabatshane WSIA.....	199
Figure 9-17: Schematic layout of UG008: Pungashe/Mhlabatshane Scheme.....	200

Figure 9-18: UG009 KwaHlongwa WSIA	203
Figure 9-19: Schematic layout of UG009: KwaHlongwa Scheme	204
Figure 9-20: UG010 Vulamehlo Farming WSIA	207
Figure 9-21: Schematic layout of UG010: Vulamehlo Farming Scheme	208
Figure 9-22: UG011: Vulamehlo WSIA	211
Figure 9-23: Schematic layout of UG011: Vulamehlo Scheme	212
Figure 9-24: UG012 Greater Vulamehlo Cross Border WSIA	216
Figure 9-25: Schematic layout of UG012: Greater Vulamehlo Cross Border Scheme	217
Figure 9-26: UG013 Kwa-Mbotho WSIA	220
Figure 9-27: Schematic layout of UG013: Kwa-Mbotho Scheme	221
Figure 9-28: UG014 KwaNyuswa WSIA	224
Figure 9-29: Schematic layout of UG014: KwaNyuswa Scheme	225
Figure 9-30: UG015 KwaNdelu WSIA	228
Figure 9-31: Schematic layout of UG015: KwaNdelu	229

LIST OF ABBREVIATIONS

CoGTA	Department of Cooperative Governance and Traditional Affairs
CR	Command Reservoir
EMF	Environmental Management Framework
DM	District Municipality
DWS	Department of Water and Sanitation
GIS	Geographical Information System
IRDP	Integrated Residential Development Programme
IDP	Integrated Development Plan
KZN	KwaZulu-Natal
ℓ/c/d	Liters per capita per day
LED	Local Economic Development Programme
LM	Local Municipality
LoS	Level of Service
m ³	Cubic meter
Mm ³	Million Cubic meter
MIG	Municipal Infrastructure Grant
Mm ³	Million Cubic Meters
Mm ³ /a	Million Cubic Meters per annum
Mℓ/day	Mega liter per day
MPNRW	Management Plan to Reduce Non-Revenue Water
NRW	Non-Revenue Water
PSP	Professional Service Provider
R '000	Rand Thousands
RBIG	Regional Bulk Infrastructure Grant
RDP	Reconstruction and Development Plan
Res	Reservoir
RF	Reference Framework
RWSS	Regional Water Supply Scheme
SDF	Spatial Development Programme
SIV	System Input Volume
UAP	Universal Access Plan
Ugu	Ugu District Municipality
VAT	Value Added Tax
WMA	Water Management Area

WSA	Water Services Authority
WSDP	Water Services Development Plan
WSI	Water Supply Intervention
WSIA	Water Supply Intervention Area
WSIG	Water Services Infrastructure Grant
WSP	Water Service Provider
WSS	Water Supply Scheme
WTP	Water Treatment Plant
WWTP	Wastewater Treatment Plant

1. OBJECTIVES AND METHODOLOGY

This report is the Bulk Water Master Plan for the study titled “Universal Access Plan Phase III – Progressive Development of a Regional Concept Secondary Bulk Water Master Plan for the Ugu District Municipality (Ugu)” – in this instance also the Water Services Authority (WSA).

This section provides the background of the study, an introduction and description of the study objectives.

1.1 BACKGROUND AND INTRODUCTION

This study follows on the Phase II study for the Development of a Universal Access Plan (UAP) for Water Supply in the KwaZulu-Natal Province which was completed in June 2016 by various Professional Service Providers (PSP's) that were appointed by Umgeni Water.

However, the level of detail within the final outcome of UAP Phase II varied between the various PSP's and the magnitude of the cost requirement resulted in Umgeni Water to revisit the process and the need for UAP Phase III was initiated. The main objective of Phase III will be to further develop the conceptual bulk water master plan that would clearly distinguish between primary and secondary bulk.

Umgeni Water appointed Mariswe (Pty) Limited (previously UWP Consulting), in association with JTN Consulting in November 2018 to review the UAP Phase II process by the developing of UAP Phase III for the whole of the KwaZulu-Natal province. The areas are as follows:

- ✓ Amajuba District Municipality (ADM);
- ✓ City of uMhlathuze Local Municipality (CouM);
- ✓ Harry Gwala District Municipality (HGDM);
- ✓ Ilembe District Municipality (IDM);
- ✓ King Cetshwayo District Municipality (KCDM);
- ✓ Newcastle Local Municipality (NLM);
- ✓ The Msunduzi Local Municipality (TM&M);
- ✓ Ugu District Municipality (Ugu);
- ✓ Umgungundlovu District Municipality (UMDM)
- ✓ Umkhanyakude District Municipality (UKDM);
- ✓ uMzinyathi District Municipality (UZDM);
- ✓ uThukela District Municipality (UTDM); and
- ✓ Zululand District Municipality (ZDM).

The abovementioned municipalities were allocated WSA status for their respective areas of jurisdiction. Amajuba, King Cetshwayo and Umgungundlovu's responsibilities as WSA excludes the areas covered by the Newcastle, City of uMhlathuze, and The Msunduzi Local Municipalities which themselves are WSA's. UAP Phase III reports are developed per WSA, i.e. 13 independent reports are prepared.

1.2 PURPOSE OF THE REPORT

This report is the second deliverable of the study, namely the Reconnaissance Study that outlines the conceptual master plan of primary and bulk regional schemes per WSA.

The UAP Phase III aims to review and update the UAP Phase II study reports in order to clearly distinguish between primary and secondary bulk water requirements. The implementation of the UAP Phase III study will be executed in two phases and are as follows:

Phase	Description	Deliverables
Phase 1	Due diligence of the conceptual Regional Bulk Scheme Reports from UAP Phase II	High Level Water Services Intervention Areas (WSIA) due diligence report outlining the viability and sustainability of the already proposed regional schemes
Phase 2	Reconnaissance into the Proposed Regional Primary and Secondary Bulk Schemes per Water Services Authority	Reconnaissance Study that outlines the conceptual master plan of primary and bulk regional schemes

Phase 1 includes the information review and conducting a due diligence of the conceptual regional bulk schemes proposed during UAP Phase II.

Phase 2 includes the development of a demand model up to 2050 and needs development plan, culminating in a Reconnaissance Study report on primary and secondary bulk water supply.

The Report would also provide status quo information on sanitation level of service per WSA inclusive of sanitation bulk scheme components. The sanitation status quo information was collected, verified and validated during the Municipal visits and incorporated within the geo database.

The UAP Phase III study information would be used to update the DWS Reference Framework (RF) geodatabase where possible.

1.3 INFORMATION SOURCES

Information used in this study was obtained from current and existing reports and inputs from knowledgeable municipal officials. The following reports were reviewed to contribute to this report:

- ✓ StatsSA Community Survey, 2016;
- ✓ UAP Phase II, Ugu District Municipality, 2016;
- ✓ Umgeni Water, Infrastructure Masterplan Volume 3, 2020;
- ✓ Ugu District Municipality Water Services Development Plan, 2018 – 2019
- ✓ Ugu District Municipality Final Draft Integrated Development Plan, 2019 – 2020; and
- ✓ Monthly water balance reports as submitted by DWS (KZN) for each WSA.

Meetings were held with managers and technical staff of Ugu to obtain their input and to ensure the latest available specifications and information is used for the purpose of this study.

Existing spatial and non-spatial data sets were used as reference such as the 2016 Community Survey, UAP Phase II Study, 2016, the Department of Water and Sanitation (DWS) Reference Framework geodatabase as well as spatial data received from the WSA itself.

1.4 STAKEHOLDER ENGAGEMENT

The PSP engaged each WSA individually during inception meetings to introduce the study, its objectives and detailed approach.

The first deliverable was a Due Diligence Report on demographics, water services levels, existing bulk water supply infrastructure, water resources, water requirements, current and planned bulk infrastructure projects and viability of water supply intervention areas. The Due Diligence also reported on a preliminary gap analysis that was conducted utilising the outcome from the proposed WSIA from UAP II and the Ugu Water Services Development Plan that is currently being updated. Following the gap analysis, specific recommendations were made when determining the 2050 water demands suggested for the UAP Phase III study. Follow-up meetings were arranged with the WSAs to share the information that are presented in the Due Diligence Report and these reports were submitted to Umgeni Water.

The Due Diligence Report has now been followed by the development of a water requirements model for 2050. Further individual engagements were held with each WSA.

This resulted in the development of a Reconciliation Report, which presents the alignment of water requirements with existing and planned bulk infrastructure and available water sources for all areas within the WSA.

The Draft Reconciliation Report was presented to each WSA to obtain comments and inputs, which were considered for the final study report submitted to Umgeni Water, DWS and COGTA.

1.5 WATER REQUIREMENTS MODEL METHODOLOGY

A report outlining the methodology, design criteria and assumptions to be used to develop the water demand model for this study, UAP Phase III was approved by the Client. The approved water demand model was then applied to determine the demands for all areas included in the study, at least at a town level. The water demands are required to inform the concept design for a design horizon period up to 2050, with the minimum level of service a yard connections at 100ℓ capita per day.

1.5.1 Total Water Demand Calculations

This section provides information on the base data used for the modelling, assumptions made and outputs of the water demand model, based on a pilot Water Services Authority area.

1.5.1.1 Base Data

The base data used for this study includes the following:

- ✓ 2011 Census: Spatial data for the Main Places, Sub-Places and Small Areas Layer. Main Places are similar to the level of towns, Sub-Places are similar to the level of suburbs and the Small Areas Layer are of a smaller level of detail than Sub-Places, encompassing a number of enumerated census areas;
- ✓ 2011 Census: alpha-numeric data, linking to the spatial data, for household income categories, combined with water Level of Service (LoS). The derived household income and LoS information was combined into categories as follows:
 - Category 1 (Very High Income): Households with a house connection and an income more than R 1 228 000 per year;
 - Category 2 (Upper Middle Income): Households with a house connection and an income between R 153 601 and R 1 228 000 per year;
 - Category 3 (Average Middle Income): Households with a house connection and an income of between R 38 401 and R 153 600 per year;
 - Category 4 (Low Middle Income): Households with a house connection and an income of between R 9 601 and R 38 400 per year;
 - Category 5 (Low Income): Households with a house connection and an income between R1 and R 9 600 per year;
 - Category 6 (Yard Connections): all Households with a Yard Connection;
 - Category 7 Households with access to interim services and
 - Category 8 Households with access to below interim services.
- ✓ 2011 Census: categorisation of Main Places – similar to town level data, based on best-known characteristics of the Main Place. The types of Towns/Centre categories include:
 - Category 1: Long Established Metropolitan Centres (M): Large conurbation of a number of largely independent local authorities generally functioning as an entity;
 - Category 2: City (c): Substantial authority functioning as a single entity isolated or part of a regional conurbation;
 - Category 3: Town: Industrial (Ti): A town serving as a centre for predominantly industrial activities;
 - Category 4: Town: Isolated (Tis): A town functioning generally as a regional centre of essentially minor regional activities;
 - Category 5: Town: Special (Ts): A town having significant regular variations of population consequent on special functions. (Universities, holiday resorts, etc.);
 - Category 6: Town: Country (Tc): A small town serving essentially as a local centre supporting only limited local activities.

- Category 7: Contiguous (Nc): A separate statutory authority or a number of authorities adjacent to, or close to, a metropolis or city and functioning as a component part of the whole conurbation;
 - Category 8: Isolated (Nis): A substantial authority or group of contiguous authorities not adjacent to an established metropolis or authority;
 - Category 9: Minor (Nm): Smaller centres with identifiable new or older established centres not constituting centres of significant commercial or industrial activity;
 - Category 10: Rural (Nr): All other areas not having significant centres.
- ✓ Population Growth: Population numbers per Small Areas Layer as provided by Umgeni Water that developed with Statistics South Africa the population growth for the following years:
- 2016; 2020; 2025; 2030; 2035; 2040; 2045 and 2050.
- ✓ 2019 Updated Levels of Service as provided by Water Services Authorities. The 2019 LoS may be recorded in different formats and at different spatial levels (settlement / town, ward, other). The following categories were applicable the pilot WSA, based on wards and spatially allocated to the Small Areas Layer:
- Below: Assumed for the purposes of this study to include all areas below the standpipe level of service in 2019;
 - At: All areas at standpipe level of service in 2019 and
 - Above: All areas above the standpipe level of service in 2019.

1.5.1.2 Assumptions

The following assumptions were made in order to calculate the demands per Small Area:

- ✓ That the ratio of population within each income category in the House Connection LoS category has not changed since 2011. The assumption is that the individuals in each category may be earning more since 2011, but that the categories themselves should have also then moved upwards by the same average quantum. The ratio of population in each category may then be assumed to have stayed more or less the same, even though the actual income values may have changed. This will not influence the demand allocated to each category.
- ✓ That the categorisation of Centres has not changed since the 2011 Census. The categorisation of Main Places may be reviewed if necessary
- ✓ The projected population growth numbers as provided by Umgeni Water was used without any further analyses.
- ✓ The 2019 updated Level of Service as provided for the pilot WSA was used, which also indicated potential future levels of service. However, it was found that some areas are marked as below standpipe level when the 2011 Census recorded these areas as above RDP level. We assumed that these areas may have been marked as below standpipe level subsequent to the Census due to factors such as water availability / reliability or other factors. It was decided, in these cases, that the infrastructure probably still exists in these areas as recorded during the Census and that it would be prudent, for

water demand modelling purposes, to assume the Census RDP levels still apply. In cases where the WSA indicated areas to be in higher categories than recorded in the Census, the WSA for Level of Service was used, since it is assumed that these areas have since been upgraded to a higher level of service. No area was therefore downgraded from the Census data, but some areas were upgraded to a higher LoS with the new 2019 data.

- ✓ Average of the Annual Average Daily Demand (AADD) values (Direct Demands) were assumed, as shown in **Table 1-1**. These were informed by the previous UAP Phase II study.
- ✓ Indirect demands, as a ratio of AADD, were assumed, as summarised in **Table 1-2** per Centre category.

Table 1-1: Assumed average AADD per person per combined income and LoS category

Category	Description of consumer category	Household Annual Income range	Average AADD (l/c/d)
1	House Connections: Very High Income	>R1 228 000	410
2	House Connections: Upper middle income	R 153 601 – R 1 228 000	295
3	House Connections: Average Middle Income	R 38 401 – R 153 600	228
4	House Connections: Low middle Income	R 9 601– R 38 400	170
5	House Connections: Low income	R 1 – R 9600	100
6	Yard Connections		100
7	Households with access to interim services		70
8	Households with access to below interim services		12

Table 1-2 Indirect demands, as a ratio of direct demands per Centre classification

Classification	Type of Centre	Description	Typical CSIR / SACN Settlement Typology	Indirect demands as a ratio of direct demands			
				Commercial	Industrial	Institutional	Municipal
1	Long established Metropolitan centres (M)	Large conurbation of a number of largely independent local authorities generally functioning as an entity.	City Region	0.2	0.3	0.15	0.08
2	City (c)	Substantial authority functioning as a single entity isolated or part of a regional conurbation.	City / Regional Centre 1 / Regional Centre 2				
3	Town: Industrial (Ti)	A town serving as a centre for predominantly industrial activities.	Regional Centre 1 / Regional Centre 2				
4	Town: Isolated (Tis)	A town functioning generally as a regional centre of essentially minor regional activities	Service Town				
5	Town: Special (Ts)	A town having significant regular variations of population consequent on special functions. (Universities, holiday resorts, etc.)	Service Town / Local or Niche Town	0.3	0.15	0.08	0.03
6	Town: Country (Tc)	A small town serving essentially as a local centre supporting only limited local activities	Local or Niche Town	0.1	0.15	0.03	0.1
7	Contiguous (Nc)	A separate statutory authority or a number of authorities adjacent to, or close to, a metropolis or city and functioning as a component part of the whole conurbation.	Regional Centre 2	0.15	0.08	0.08	0.08
8	Isolated (Nis)	A substantial authority or group of contiguous authorities not adjacent to an established metropolis or authority.	High Density Rural				
9	Minor (Nm)	Smaller centres with identifiable new or older established centres not constituting centres of significant commercial or industrial activity.	Local or Niche Town				
10	Rural (Nr)	All other areas not having significant centres.	Rest of South Africa				

✓ The phased upgrading of Level of Service up to 2050 was assumed as summarised in **Table 1-3**.

Table 1-3 Level of Service Upgrade

Dwelling Type	LoS Upgrade
House Connections: Very High Income	Grows with Population growth
House Connections: Upper middle income	Grows with Population growth
House Connections: Average Middle Income	Grows with population growth + additional 2.5% increase from Low Middle Income by between 2019 and 2030 + additional 5% increase from Low Middle Income between 2031 and 2050
House Connections: Low middle Income	Grows with population growth + additional 5% increase from Low Income by between 2019 and 2030 + additional 10% increase from Low Income between 2031 and 2050
House Connections: Low income	Grows with population growth + additional 7.5% increase from Yard Connections by between 2019 and 2030 + additional 15% increase from Yard Connections between 2031 and 2050
Yard Connections	Grows with Population growth + minimum LOS by 2030
Households with access to interim services	Reduce to 0 by 2030
Households with access to below interim services	Reduce to 0 by 2030

- ✓ Finally, an additional 10 % and 15% were added to the total water demand (Sum of Direct and Indirect Demands) for water treatment losses and distribution losses respectively.

1.5.1.3 Output of the Water Demand Model

The output of the water demand model is a total water demand (including direct demands, indirect demands and acceptable losses) for 2019; 2020; 2025; 2030; 2035; 2040; 2045 and 2050 per Small Area, in Million Cubic Meters per annum (Mm³/a). This water demand will be compared to available supply demands if possible and an opinion on potential discrepancies will be given.

As the output is based on the Census Small Areas Layer and coded accordingly, it can be used in a GIS environment for further analysis.

1.6 DWS REFERENCE FRAMEWORK GEODATABASE

The DWS Directorate: Water Services – Planning and Information – maintains a national database for water services planning. It is a spatial database, in a GIS format, that includes layers for settlements, water supply infrastructure, sanitation supply infrastructure, water resources and projects.

This study aims to update the service levels for settlements based on feedback from each WSA. Furthermore, where possible, the bulk and reticulation infrastructure components in the geodatabase were also updated to include not only the latest existing, but also planned water supply infrastructure.

1.7 RECONNAISSANCE REPORT

The final deliverable of this study is a Reconnaissance Report – this report – to reconcile the water requirements, with available water sources, for all areas in a WSA. This includes the evaluation of existing capacities of infrastructure, potential extensions to new areas, or scheme development options for areas where linkage to existing schemes are not feasible.

The potential costs for scheme development and timeframes were investigated and are presented in this report. Umgeni Water provided unit reference costs for infrastructure components that have been applied where possible.

Information on available water sources were mainly obtained from existing DWS Reconciliation Strategies (larger systems and from the All Towns Studies). Where available, project-specific studies or technical reports were consulted to verify information on available water sources. Information on groundwater availability and quality is however not readily available to a sufficient level of detail.

2. STUDY AREA

This section provides an overview of the study area, setting the scene and discusses the institutional arrangements for water supply. It also provides a brief overview of the demographics in the area and the development opportunities.

2.1 CONTEXT

The Ugu District Municipality (DC21) is located in the southern region of the KwaZulu-Natal Province and it covers an area of approximately 5 047 km². The municipality is surrounded by Umgungundlovu DM and eThekweni to the north, Alfred Nzo DM to the south, Harry Gwala DM to the west and 112 km of coastline to the east.

Ugu DM consists of the following four Local Municipalities:

- ✓ Umdoni Local Municipality (KZN212);
- ✓ Umzumbe Local Municipality (KZN213);
- ✓ Umuziwabantu Local Municipality (KZN214); and
- ✓ Ray Nkonyeni Local Municipality (KZN216).

The district is comprised of two (2) distinct areas that are divided by the N2 freeway, the coastal strip which is largely urban, and the inland expanse which is rural. The rural-urban divide is a glaring feature in terms of development challenges as 80% of the land is rural and only 20% is urban.

The main urban centres within Ugu are Port Shepstone, Hibberdene, Scottburgh, Margate, Port Edward and Harding Town. These centres serve as the main towns for the municipal area with the highest cluster of commercial activities.

Ezinqolweni is the main rural town that is found within the municipal area. Turton, within Umzumbe, is experiencing an increase in density marked by a phenomenal increase in the number of people that live within the area. It is surrounded by the densely populated rural settlements which have grown around it over the years. (IDP, 2019)

Majority of the inland area is occupied by rural villages and settlements. These are spread within different parts of the administrative boundaries of traditional authorities. These villages and settlements have a number of commercial and social activities within it. The kind of commercial activities are limited to small local convenient shops, taverns as well as scale manufacturing activities (block making) and personnel services such as salons and small-scale agricultural activities (ploughing field and food gardens). (IDP, 2019)

The study area and locality of Ugu DM is illustrated in **Figure 2-1** overleaf.

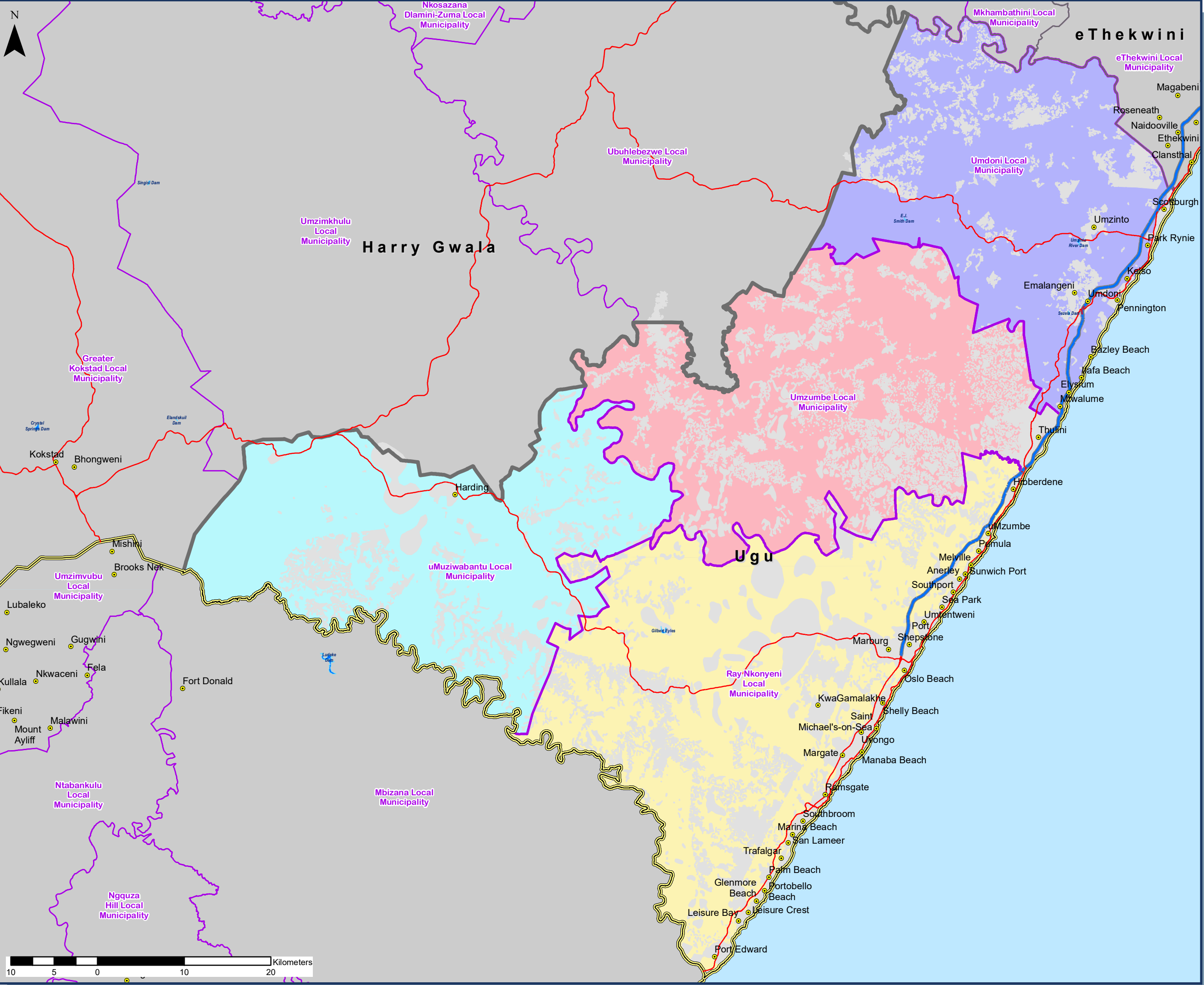

Legend

- Provincial Boundaries
- District Municipality Boundaries
- Local Municipality Boundaries
- National Roads
- Main Roads
- Dams & Dam Names
- Rivers
- Settlements
- Major Towns

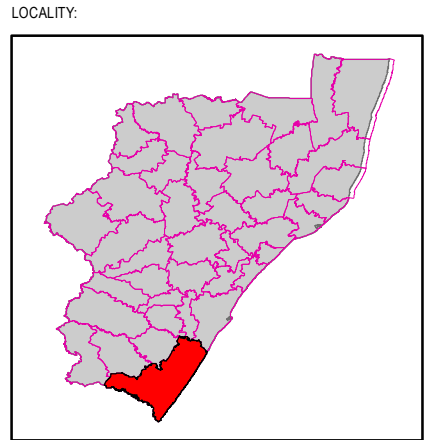

CLIENT:

MUNICIPALITY:

UGU DISTRICT MUNICIPALITY

CONSULTANTS

Project No.: 27814

Mariswe
PO Box 25549, Monument Park
Pretoria, 0105

Tel: +27 (0) 12 424 9700
Fax: +27 (0) 12 460 4071
Email: pretoria@uwp.co.za

PROJECT TITLE

UGU DM: Universal Access Plan Phase III - Progressive Development of a Regional Concept Secondary Bulk Water Master Plan

MAP TITLE:

Locality Map
UGU District Municipality

DATE COMPLETED:

January 2021

MAP NO.:

DC 21 Figure 2-1



2.2 PHYSICAL CHARACTERISTICS OF THE STUDY AREA

The DM is accessed via the N2 and the R102 from eThekweni in the north. The N2 is an important access point as it stretches throughout the district and provides regional access to the Eastern Cape province on the western border where it borders with Harry Gwala District Municipality. The R61 links the district with the Eastern Cape in the South where it borders with the Alfred Nzo District Municipality whilst the R102 links the district with Umgungundlovu DM to the west.

Ugu has several strategic features such as the following:

- ✓ It is highly accessible by the N2 and R61 which connects the area with a number of towns within KwaZulu-Natal as well as the Eastern Cape and beyond;
- ✓ It is situated within a highly admired coastal strip which is affectionately referred to as the South Coast by the tourists, residents and general travellers;
- ✓ It shares borders with eThekweni Municipality which is the economic powerhouse of KwaZulu-Natal and a very notable economic point within the country; and
- ✓ It accommodates the first coastal commercial hubs from Eastern Cape to KwaZulu-Natal.

The coastal plains are generally flat along the coast, however, immediately rising and becoming undulating westwards (inland). The DM has a number of major rivers flowing through and discharging into the Indian Ocean. Ugu contains three main river systems (Umkomaas, Mzimkhulu and Mtamvuna) as well as several smaller, but significant, rivers.

2.2.1 Umdoni Local Municipality

As of 2016, the former Vulamehlo LM was disestablished and its municipal area merged into both the Umdoni LM and eThekweni Metro. The Umdoni LM abuts eThekweni to the north and Umzumbe LM to the south, making it almost halfway from Port Shepstone and Durban. The municipality is conveniently located about 50 km from Durban and 65 km from Port Shepstone. Umdoni has an approximate coastline of 40 km and stretches inland as far as Kenterton. It includes the towns of Scottburgh, Umzinto and urban areas and settlements such as Amandawe, Emalangeneni and Amahlongwa and Dududu. (IDP, 2019)

The municipality can be divided into three major land uses, being commercial agriculture, traditional authority areas and coastal urban nodes.

2.2.2 Ray Nkonyeni Local Municipality

As of 2016, the former Ezinqoleni Local Municipality was disestablished and was merged into the Hibiscus Coast Local Municipality and renamed Ray Nkonyeni Local Municipality. The LM is the largest of the four (4) municipalities in the district, making up a third of its geographical area and is ranked number fifth of all the local municipalities in terms of population in KZN.

The municipality borders the Indian Ocean in the east while the southern part of the municipality runs along the Umtamvuna River which is the boundary between KZN and the Eastern Cape. The north-western part of the LM is bordered by Umuziwabantu LM while Umzumbe LM borders the northern part. Its boundary extends further to the hinterland which is rural and these areas are administered under traditional authority.

The LM covers an area of approximately 90 km of coastline comprising some 21 beaches, and extends 30 km inland, covering a vast and rural area. It has its administrative seat in Port Shepstone and is the most concentrated economic hub within the district.

Beaches of world-class quality are to be found along the entire seaboard, with Marina, Trafalgar, Lucien, Southport, Umzumbe and Ramsgate beaches recognised as full Blue Flag beaches. The coastline is dotted with numerous small towns, many of which serve as seasonal recreational hubs in areas such as Port Shepstone, Umtamvuna/Port Edward, Margate, Hibberdene and Impenjati/Southbroom. (IDP, 2019)

2.2.3 Umzumbe Local Municipality

Umzumbe LM runs along the coast for a short strip between Mthwalume, Hibberdene, and then balloons out into the hinterland for approximately 60 km. It covers a vastly, large rural area of some 1 221 km² with approximately 1% being built up/semi-urban area.

The municipality is the third largest municipality within the DM following the amalgamation of Hibiscus Coast Municipality with Ezingoleni Municipality (now collectively known as Ray Nkonyeni) and Umdoni Municipality with a portion of Vulamehlo Municipality.

There are no established towns in the municipality and is characterized by a vast backlog of basic services, high levels of poverty and minimal economic base. The primary node, Turton, has been provincially prioritized as one of among 13 towns requiring formalization in the province. The most striking physical feature is the extent of undeveloped natural land which represents almost 60% of the total land area.

Agriculture is the mainstay of the economy with the main activities being sugar cane and small-scale farming, as well as a small business community. (IDP, 2019)

2.2.4 Umuziwabantu Local Municipality

The Umuziwabantu LM lies at the foot of the Ingeli Mountain Range and the Umtamvuna River marks the southern boundary. It shares its borders to the north, west and south with the Eastern Cape, and to the east with the Umzumbe and Ray Nkonyeni Municipalities. (IDP, 2019)

The LM consists of a largely rural area. Features include an urban development (the town of Harding), farmland, commercially-grown forests, and traditional authority areas. Apart from the town of Harding, which

is the seat of the municipality, 56% of the municipal area is occupied by individually-owned commercial farms and the Weza afforestation region.

2.3 CLIMATE AND CLIMATE CHANGE

The Ugu DM experiences a warm sub-tropical climate, with most rainfall being experienced during the spring and summer months (October to March). The highest rainfall is typically experienced over December and January of any year. Climatic conditions vary greatly between the coast and inland, with conditions and temperatures associated with the coastal areas being moderated by the effects of the warm Indian Ocean.

The mean daily temperature at Port Shepstone, which is deemed representative of the district, is 20.3 °C, ranging from an average minimum of 16.9 °C to an average maximum of 23.7 °C with an average annual rainfall of 1 140 mm, as per the South African Weather Services. (UAP Phase II, 2016)

The climate of Ugu DM can be categorised into three (3) distinct climate zones. These are coastal, inland north and inland south.

- ✓ The coastal climatology is influenced largely by the proximity to the warm Agulhas Ocean current. The thermal heat retentive capacity of the ocean reduces the diurnal temperature range and thus results in more mild temperatures along the coastal areas. The warm ocean current along the eastern coast provides water that is more predisposed to evaporation. Coastal areas therefore experience high humidity and significantly more precipitation than inland and west coast areas.
- ✓ The inland climate zones do not receive the mitigation effect of proximity to the ocean and therefore have a larger diurnal temperature range. This is particularly noted in the northern inland areas which has the highest annual average daytime temperature. The inland southern areas partly cover higher altitude areas and will therefore have a reduced annual average temperature with increased altitude inland. The precipitation profile is very similar between the inland northern and southern areas and both exhibit reduced precipitation from that which is noted toward the coast.

The Ugu District is already familiar with climate related extremes in the form of droughts and flooding, posing a significant risk to the region's economy, ecosystems, and population. However, the impact of a changing climate will stretch beyond the impact of extreme events. Considering the socio-economic and environmental challenges currently faced by the Ugu District, increasing costs associated with the projected climate change impact will compromise growth and development goals. (IDP, 2019)

Climate related extreme events and long-term impact has already and will continue to place a significant financial burden on public sector service delivery, compounded by prevailing socio-economic and environmental factors contributing to overall vulnerability. This burden will continue to increase, if climate change is not adequately addressed across district through effective response strategies.

Climate change embraces far more than temperature change and may include changes in rainfall patterns, sea level rise, the spread of infectious diseases such as malaria, increased alien vegetation invasion and loss of biodiversity:

- ✓ An increase in the frequency and intensity of floods and droughts;
- ✓ A decrease in water availability due to changed rainfall patterns and increased evaporation; this will affect subsistence dry land farmers the most;
- ✓ An increase in erosional capacity of river courses, resulting in the loss of more topsoil, thus decreasing the agricultural value of land and increasing siltation in dams;
- ✓ Infrastructural damage as a result of extreme weather events causing flooding, affecting human wellbeing and safety as well as insurance costs;
- ✓ An increase in erosion of coastal areas due to sea-level rise;
- ✓ Higher energy consumption due to increased residential cooling load;
- ✓ An increase in economic losses due to property damage and decreased tourism revenue;
- ✓ An increase in heat-related vector-borne (e.g. malaria) and water-borne (e.g. cholera) illnesses;
- ✓ An increase in heat stress, leading to dehydration, particularly for those that reside in the urban areas, as well as children and the elderly;
- ✓ Changes in the geographical distribution of plants and animals with extinction of species that are unable to move and an increase in the prevalence of alien invasive species. This will negatively affect the biodiversity of the Ugu Area of jurisdiction and the associated goods and services;
- ✓ Further loss of critically endangered grassland habitats as they are outcompeted by woody species able to utilize the higher concentrations of CO₂ in the atmosphere;
- ✓ A reduction in yield of staple food crops, such as maize;
- ✓ Changes in the optimal planting and harvesting dates for crops as well as land suitable for crop production;
- ✓ Heat stress increasing livestock and poultry mortality rates;
- ✓ An increase in respiratory problems in the city due to a decrease in air quality (e.g. changes in the concentration and distribution of near-surface ozone) and increased dampness; and
- ✓ Deterioration of foods leading to increased incidents of food-borne diseases.

The likely climate change impacts have been assessed and plans, programmes and projects have been developed to assist Ugu in dealing with these impacts. (IDP, 2019)

2.4 TOPOGRAPHY, GEOLOGY AND SOILS¹

¹ Sourced from the UGU EMF: Biodiversity Assessment, 2013

The coastline of the Ugu DM extends for roughly 112 km between the towns of Scottburgh in the north and Port Edward in the south. Elevations across the DM range from 0m (sea level) along the coastline to altitudes of nearly 1500m above mean sea level further inland near Harding/Weza in the west.

The general topography along the coastline is relatively gentle, changing dramatically as one proceeds inland towards the plateau, with undulating river valleys, deep gorges and steep hillslopes generally encountered. North facing slopes are characteristically warmer and drier than South facing slopes, which tend to be cooler and wetter, commonly providing favourable conditions for supporting indigenous forest vegetation in higher rainfall areas. Valley sides often exceed gradients of 40%, and cliff faces are common within many of the river valleys. The general slope of the land is between 1:5 and 1:6 and is susceptible to soil erosion where it is not carefully managed.

Parent geological material along the coast includes the Dwyka Series occurring south of the Umkomaas River, inland from the Umtwalume River to the Ifafa River, south of the Mzimkulu River and north of the Umtentweni River. Slight-moderate erosion occurs. Alluvial deposits occur along estuaries and river flood plains, highly productive soils ranging from sandy through loamy to clay deposits, rich and humus, prone to extensive development pressure for cultivation activity. Sands that are overlaying the bluff beds are berea red sands representing the old dunes. – north of Sezela, south of Mpambanyoni and south of Mkomaas rivers. Sands colour generally range typically from white to gray, red or brown to yellow depending on the oxidation state of the iron containing minerals coating the quartz grains, typically poor for cultivation as they are subject to erosion if disturbed through inappropriate development. Dolorite is found along the uMzumbe coast and in the vicinity of the Damba River. Soils are usually non-structured clay formations with loam. High agricultural potential. Sections of structured upland clays become waterlogged and there are extensive deposits of Gneiss (Granite) along the entire coast with cretaceous marine sediment deposits. Small quantities of gold, asbestos, limestone, kaolinite, bauxite, graphite, copper and nickel occur on the coast. (IDP, 2019)

2.5 ENVIRONMENTAL²

Historic levels of transformation and land use have resulted in dramatic impacts to the environment, particularly along the coastal zone and higher rainfall areas. Levels of transformation are such that a large number of ecosystems are now critically endangered and stand out amongst the most critical areas in the country for biodiversity protection. This has considerably compromised ecological infrastructure and the goods and services available to society, which will significantly affect the district's ability to adapt and respond to pressures such as climate change and water quality deterioration. This has also resulted in widespread species decline.

² Sourced from the Ugu DM EMF SEMP (Final) 2018

The Ugu DM has some areas of environmental significance, however only 2% of the land surface area is formally protected and development restricted. Such protected areas include steep land which is difficult to service or is prone to erosion and river flood lines, where development cannot encroach and riverine and estuary systems.

While opportunities for protection and improved management still remain, socio-economic drivers such as agricultural expansion, the spread of alien invasive plants and deteriorating water quality will continue to erode the remaining environmental assets.

There is a well-developed commercial agricultural sector and a poorly developed small holding sector in the rural areas of the district. The majority of land in the Ugu DM that can be used for different forms of agricultural production in the district has already been identified and/or is being utilised. An exception to this may be in the drier areas where there may be good soils and associated production conditions, but these can only be realised with water (if available) for irrigation purposes.

The district contains four main river systems (Lovu, Umkomaas, Mzimkhulu and Mtamvuna) as well as a number of smaller rivers. The catchments are in a good ecological state and are not greatly influenced by anthropogenic impacts. Most rivers, including the two major perennial rivers (Mtamvuna and Mzimkhulu), are reported as being in good condition (A/B class). The Mtamvuna and Mzimkhulu rivers are free-flowing, which is noteworthy, considering levels of impoundment of most rivers in South Africa. A number of the smaller rivers are more heavily modified and classified as moderately (C class) to heavily (D class) impacted. While detailed information is lacking for some of the smaller rivers, surrounding land cover suggests that many of these systems are “not intact”, including a large number of discrete, short river systems flowing into the Indian Ocean. Generally, rivers in the district are in reasonable condition.

The majority of wetlands in the district occur within higher rainfall areas, resulting in high densities of wetlands along the coastal region and fewer located inland. As a result of intensive urban development along the coast and agricultural practices (commercial and informal), an estimated 67% of wetland areas have been subject to transformation, significantly affecting the ecosystem services derived from these resources.

In terms of land assets (i.e. land cover types) of Ugu, these produce a wide variety of ecosystem services, including those within the built environment. The assets in rural areas are in relatively good condition in comparison to those in the coastal areas due to lower levels of transformation. Similarly, assets in close proximity to settlement areas are generally in poorer condition than those further away. A wide range of ecosystem services are supplied by the land cover types within the Ugu DM, including: carbon storage / sequestration, crops, fruits & vegetables, flood attenuation, landbased recreation, temperature moderation, fibre and poles, waste assimilation and soil stability / retention. These services are delivered at high levels due to the landscape assets inherent in Ugu.

There is a broad mix of land uses in the study area, which results in varied air quality across the area, whereby emissions vary for rural versus developed / urban areas as a result of the type of emissions sources. Agricultural and some rural areas are responsible for emissions related to biomass burning while the more urbanised areas have higher industrial and transport related emissions. The bulk of industrial emissions emanates from Port Shepstone. In terms of management of air quality in Ugu and its local municipalities, up-skilling and increased capacity are required within local municipal structures.

A significant number of unidentified and poorly documented historical and cultural resources occur, as well as resources that have been recorded but for which geographic coordinates are unavailable at present. These consist of memorials, places of worship (churches, mosques and temples), cemeteries, open spaces, areas of political significance and areas of past economic significance, to mention but a few. Few comprehensive and accurate records exist for heritage resources in the area.

The Municipality is aware that environmental accounting needs to become more integrated into the development planning process and must be considered in the very initial phases of planning any new development or upgrade, prior to any costly mistakes being made.

2.6 INSTITUTIONAL ARRANGEMENTS FOR WATER SUPPLY

The Ugu District Municipality (Ugu) is one of the eleven district municipalities in KwaZulu-Natal. The water supply to the District is derived from dams, rivers, ground water and bulk purchases from eThekweni and Umgeni Water. The water is then treated at several treatment plants, owned by Ugu before being distributed to households. (IDP, 2019)

The Ugu DM is the water service authority (WSA) and water service provider (WSP) to its four local municipalities, namely:

- ✓ Umdoni Local Municipality (KZN212);
- ✓ Ray Nkonyeni Local Municipality (KZN216);
- ✓ Umzumbe Local Municipality (KZN213); and
- ✓ Umuziwabantu Local Municipality (KZN214);

Ugu Water Services has been mandated to perform the water services provision function and is therefore also the Water Services Provider (WSP) including the functions of bulk water provision, water reticulation, sewerage services and bulk wastewater collection and treatment to the towns and villages in its area of jurisdiction.

3. DEMOGRAPHICS

3.1 EXISTING POPULATION DISTRIBUTION

The Ugu DM is in the process to review their WSDP and has updated their demographics accordingly in the 2018/2019 Water Services Development Plan.

As the WSDP demographics for Ugu DM has not been updated to date and does not reflect the latest demographics when compared to the reference framework, the UAP Phase III will adopt the figures reflected by the DWS Reference Framework (2019).

There is currently 785 792 people within 216 781 households residing within 338 communities within Ugu DM. The average household size is 3.62 persons per household. It is noted that Ray Nkonyeni LM hosts 46% of the population within Ugu. The population distribution of HGDM is illustrated in **Figure 3-1** overleaf.

The population and household figures per Local Municipality are tabled in **Table 3-1** below.

Table 3-1: Population & Household Figures for Ugu DM

Municipality	No of Population	No of Households	People per Household
Umdoni	150 673	45 272	3.33
Ray Nkonyeni	364 413	95 637	3.81
Umzumbe	157 263	53 415	2.94
Umuziwabantu	113 443	22 457	5.05
Total	785 792	216 781	3.62

Source: DWS Reference Framework, April 2019

The Community Survey 2016 yielded a growth rate of 2.03% for the Ugu DM from 2011 to 2016. Umzumbe Local Municipality, among a few other LM's within KwaZulu-Natal, recorded a negative growth rate from 2011 to 2016 due to communities migrating to urban centres to seek better work opportunities or facilities.

Table 3-2 below presents the populations and growth rate for Ugu as at 2016.

Table 3-2: Population and Growth Rate: 2011 – 2016

Municipality	Population 2011	Population 2016	Growth Rate (%)
Umdoni	130 413	144 551	2.34
Ray Nkonyeni	308 675	348 533	2.76
Umzumbe	153 407	151 676	-0.26
Umuziwabantu	96 556	108 576	2.67
Total	689 051	753 336	2.03

Source: StatsSA, Community Survey 2016

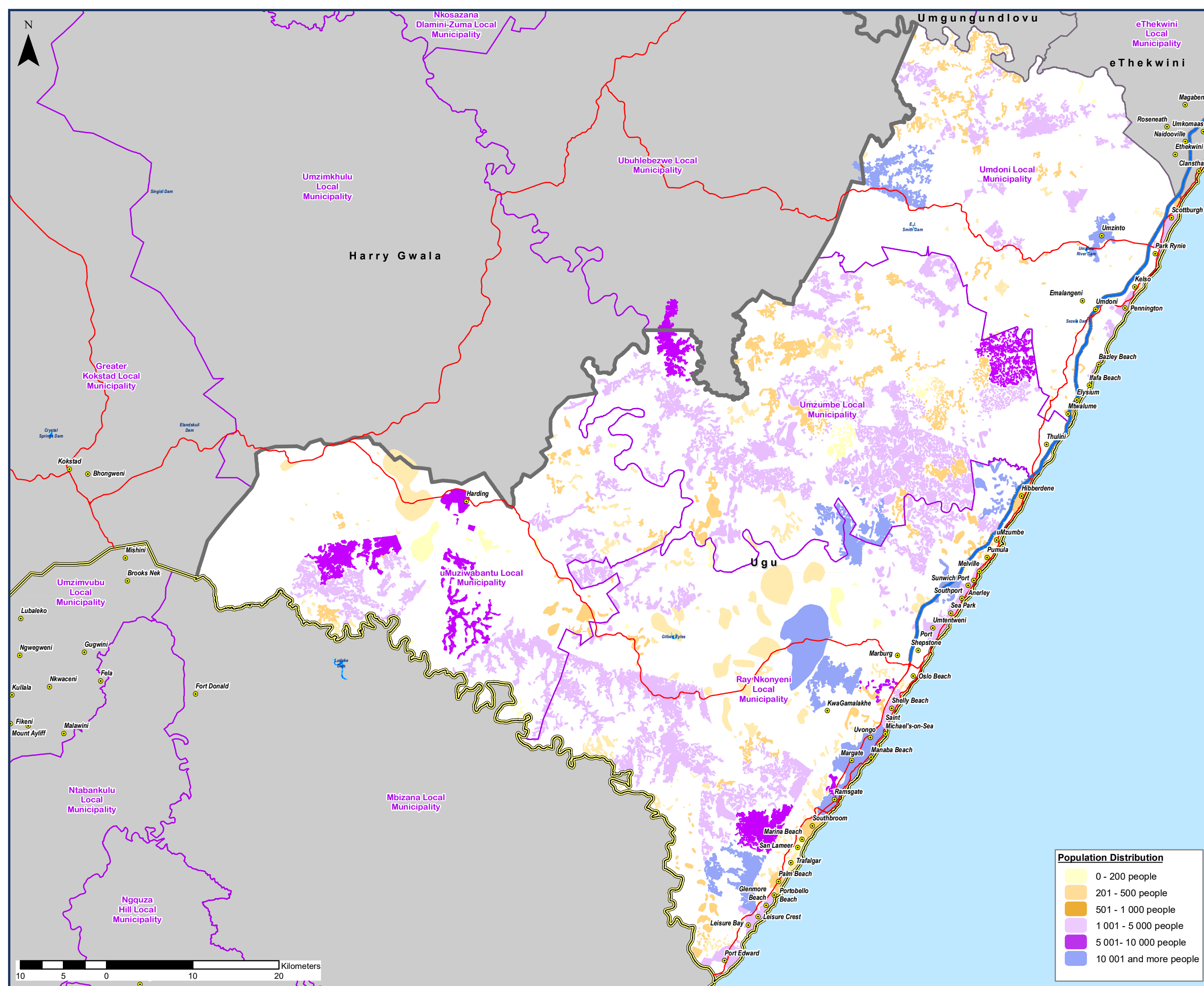

Legend

- Provincial Boundaries
- District Municipality Boundaries
- Local Municipality Boundaries
- National Roads
- Main Roads
- Dams & Dam Names
- Rivers
- Settlements
- Major Towns

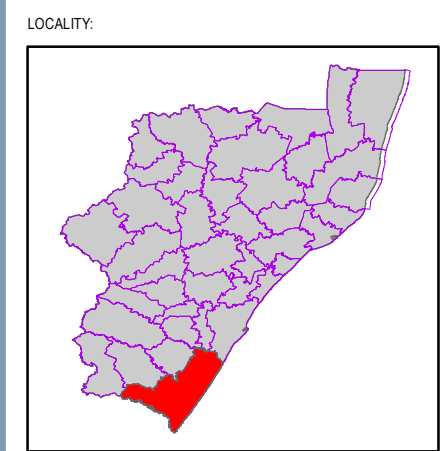

CLIENT:

MUNICIPALITY:

UGU DISTRICT MUNICIPALITY

CONSULTANTS

Project No.: 27814

Mariswe
PO Box 25549, Monument Park
Pretoria, 0105

Tel: +27 (0) 12 424 9700
Fax: +27 (0) 12 460 4071
Email: pretoria@uwp.co.za

PROJECT TITLE

UGU DM: Universal Access Plan Phase III - Progressive Development of a Regional Concept Secondary Bulk Water Master Plan

MAP TITLE:

Population Distribution
UGU District Municipality

DATE COMPLETED: January 2021

MAP NO.: DC 21 Figure 3-1

Population Distribution

- 0 - 200 people
- 201 - 500 people
- 501 - 1 000 people
- 1 001 - 5 000 people
- 5 001 - 10 000 people
- 10 001 and more people

The current population density of the Ugu District Municipality is 153 people/km². The coastal belt has the largest population densities as this is the economic hub of the district which is host to the Umdoni and Ray Nkonyeni Local Municipalities. The move further inland sees the population densities drop as this area is mainly rural and has dispersed settlements. (IDP, 2019)

3.2 SOCIAL AND ECONOMIC INDICATORS³

The Ugu DM constitutes 5% of the area and $\pm 7\%$ of the population of KZN. The district municipality has a well-developed economic infrastructure in terms roads, highways, railroads, airports, electricity, telecommunications, water supply and sanitation. All these supports any development that is intended to be established or that already exist within the municipality that helps in developing the economy of the areas within the district.

With well-established roads the municipality attracts tourists from other areas which also assist with the economic development of the municipality. The transport infrastructure on the South Coast is well-developed and provides the area with a competitive advantage. The competitive advantage relates particularly to the N2 road and rail access to the south of the eThekweni Municipality, the industrial hub of the Province and eastern seaboard.

The basic airport infrastructure (in terms of specifically the runway) is also sufficient to support a much busier aviation sector than is currently the case. Potentially the sea access could also be developed to support the development of the tourism, industrial and commercial sectors. The move of Durban International to the north of Durban will potentially increase the value of the Margate Airport for the region.

The linking of production, processing and manufacturing activity around the Margate Airport, to export activities at the Dube Tradeport should receive consideration. The agri-business focus of the Dube Tradeport should specifically be considered in this regard. The Wild Coast N2 toll road will further link the Ugu District Municipality to the Eastern Cape and the urban centres of Mthatha, East London and Port Elizabeth. Other than just the linking of urban centres along the eastern seaboard it is also anticipated that the route will develop a new tourism corridor, as well as potentially open up mining opportunities on the coast (to the south of Ugu).

Ugu DM is a notable service centre within the south of KwaZulu-Natal and the northern part of the Eastern Cape Province. It provides highly competitive tertiary services within these regional parts of both provinces, such services mainly include commercial, retail and tourism. The district also attracts a number of people for public services including medical care given the amount of public and private health care facilities.

The Ugu District Municipality has five main economic contributors which are:

³ Sourced from Ugu DM IDP, 2019

✓ Agriculture

The Ugu DM is blessed with large tracts of fertile soil. Temperate, mild climate with no winter zones, allow for a large variety of crops to possibly be grown over small rivers and several small dams spread around the district with a couple of irrigation schemes to be upgraded.

The main crop produced is sugar cane, however, there are also forestry plantations, although timber processing takes place largely outside the district. Banana farming, poultry, cattle and goat farming, as well as vegetable farming, occur on a limited scale. Tribal land is used for subsistence farming and only an extremely small part of the land is dedicated to commercial farming.

Sugar cane is sold to the two sugar mills which are within the district and timber is sent to Durban for processing and local furniture manufacturers end up buying the material back from Durban once it is processed. Vegetables and poultry are largely sold to people in the local communities.

✓ Tourism

The tourism industry is a key contributor to the KZN and Ugu economy which is buoyant with the major activities based on the sea and associated activities. The development and implementation in the Ugu region is driven and headed by the Ugu South Coast Tourism Entity.

✓ Manufacturing (Industrial)

The sector has been largely ignored in terms of analysis and funding by local authorities. The manufacturers are quite small and suffer from competition from larger factories outside Ugu and the few bigger manufacturers often struggle to find a reliable long-term supplier locally (e.g. within the furniture sub-sector, suppliers of inputs like wood and lacquer).

There are however opportunities that can be explored within the sector such as the labour that is relatively cheap and the coastal area is connected to bigger centres like Durban. The housing and property sector is booming in the area (i.e. increasingly more people want to move to or retire on the South Coast), and some manufacturing sub-sectors like furniture should benefit from that.

Spatially, manufacturing remains clustered close to the major nodes of Port Shepstone and Marburg, due to the availability of serviced land and connectivity to the N2 network. Ugu DM's major manufacturing activities include clothing, textiles, metal products, cement production, food and beverages and wood products. Ugu has the only 'marble' delta within the province, mined for cement and calcium carbonate. NPC CIMPOR is the province's premier cement manufacturing company and has developed an R 800 million operation in the Oribi Gorge region.

✓ Trade and Commerce

The sector comprises about 56% of the Ugu economy and includes wholesale and retail trade, finance and business services, community, social and other personal services including provincial and local government, hairdressing, funeral services. Within the local municipalities, the sector constitutes about 60% of the economy in Ray Nkonyeni, about 50% of the economies in Umdoni, Umzumbe and Umuziwabantu, and about 36% of the economies in Umdoni and Ray Nkonyeni. The main commercial hubs in Ugu are Port Shepstone, Shelly Beach, Margate, Port Edward, Hibberdene, Pennington, Scottburgh, Dududu, Phungashe, Ezinqoleni and Harding.

✓ Mining

There is negligible new investment in the sector. Reasons offered for this poor performance include the impact of the National Credit Act, especially in the construction sector, electricity supply shortages; competition from cheap cement imports and the global economic recession. The sector is highly capital intensive and requires market stability to encourage investment.

In order to gain perspective on the economic situation within a specific area, the Gross Value Added (GVA) contribution for that specific area is considered. **Table 3-3** below provides an overview of the GVA contribution per economic sector for South Africa, the KwaZulu-Natal Province and the Ugu District Municipality.

Table 3-3: Ugu Gross Value-Added Contribution

Economic Sector	South Africa		KwaZulu-Natal		Ugu DM	
	2005	2015	2005	2015	2005	2015
GVA (R/million)	1 469 238	3 589 803	243 330	582 450	9 976	25 642
Agriculture	3%	2%	4%	4%	9%	8%
Mining	7%	8%	2%	4%	9%	8%
Manufacturing	18%	13%	23%	18%	16%	15%
Utilities	2%	4%	2%	4%	3%	4%
Construction	3%	4%	3%	5%	3%	4%
Retail trade	14%	15%	15%	15%	17%	17%
Transport	11%	10%	15%	14%	12%	12%
Business services	21%	21%	18%	18%	17%	15%
Social services	6%	6%	6%	6%	8%	7%
Government services	15%	17%	13%	16%	14%	16%
Total	100%	100%	100%	100%	100%	100%

From **Table 3-3**, it is clear that the greatest contribution towards Ugu District Municipality's GVA in 2015 was made by the retail trade sector at 17% (approximately R4.2 billion). This sector is closely related to tourism

and associated activities, highlighting the importance of tourism within Ugu. The second largest contributor towards Ugu's GVA is the manufacturing sector at 15.2% (approximately R3.9 billion), as Ugu is amongst others. known for its strong representation of the manufacturing sector. This is also a good reflection of the Ugu GDS' vision for the District, which aims to become a leading tourism destination and manufacturing hub.

Table 3-4 below shows the local GVA sectoral contribution for each of the local municipalities contained within Ugu District Municipality. The sectors performing best overall in the District (i.e. retail trade, manufacturing and business services) are also performing well within each of the local municipalities – however, the government services sector holds the greatest GVA share in UMuziwabantu, and second largest in Umdoni and Umzumbe Local Municipalities. A high dependency on the government services sector is a negative indication as income from the government does not represent new income generation.

Table 3-4: Sectoral share of GVA at current basic prices per LM within Ugu DM, 2015

Economic Sector	Umdoni	Umzumbe	Umuziwabantu	Ray Nkonyeni
Agriculture	10%	6%	12%	7%
Mining	0%	0%	1%	1%
Manufacturing	15%	12%	13%	16%
Utilities	4%	4%	3%	5%
Construction	4.7%	6%	5%	5%
Retail trade	16%	20%	17%	16%
Transport	13%	13%	14%	11%
Business services	13%	13%	9%	17%
Social services	7%	8%	7%	7%
Government services	16%	17%	18%	15%
Total	100%	100%	100%	100%

Employment is considered as one of the 'big three' economic indicators along with inflation and GDP/GVA, when analysing the economic situation for a specific area or region. Employment rate, sectoral employment share and skills level all contribute to establishing the employment and labour profile of a specific area, such as Ugu District Municipality. **Table 3-5** overleaf contains the employment sector share per economic sector for South Africa, KwaZulu-Natal and Ugu District Municipality.

Table 3-5: Sectoral share of employment, 2005 and 2015

Economic Sector	South Africa		KwaZulu-Natal		Ugu DM	
	2005	2015	2005	2015	2005	2015
Jobs	10 792 586	11 346 221	1 734 292	1 773 124	89 925	91 337
Agriculture	3%	2%	4%	4%	9%	8%
Mining	7%	8%	2%	4%	9%	8%
Manufacturing	18%	13%	23%	18%	16%	15%
Utilities	2%	4%	2%	4%	3%	4%
Construction	3%	4%	3%	5%	3%	4%
Retail trade	14%	15%	15%	15%	17%	17%
Transport	11%	10%	15%	14%	12%	12%
Business services	21%	21%	18%	18%	17%	15%
Social services	6%	6%	6%	6%	8%	7%
Government services	15%	17%	13%	16%	14%	16%
Total	100%	100%	100%	100%	100%	100%

Table 3-6 below reveals the employment share per economic sector for each local municipality within Ugu District Municipality. From the table it is revealed that except for Umdoni, the government services sector holds the greatest share of employment for the local municipalities in Ugu.

Table 3-6: Sectoral share of employment per LM within Ugu DM, 2015

Economic Sector	Umdoni	Umzumbe	Umuziwabantu	Ray Nkonyeni
Agriculture	19%	12%	20%	13%
Mining	0%	0%	0%	0%
Manufacturing	10%	9%	8%	10%
Utilities	0%	0%	0%	1%
Construction	4%	5%	4%	5%
Retail trade	16%	19%	17%	17%
Transport	3%	3%	3%	3%
Business services	11%	12%	10%	14%
Social services	18%	19%	16%	19%
Government services	17%	20%	21%	19%
Total	100%	100%	100%	100%

When considering the contribution of sectors within the local municipalities within Ugu, towards the sector share in Ugu, it is clear that Ray Nkonyeni holds the greatest share of employment for all economic sectors (approximately 59%). The sectoral employment split per local municipality within the district employment contribution is set out in the **Table 3-7** overleaf.

Table 3-7: Contribution of LMs to sectoral employment, 2015

Economic Sector	Umdoni	Umzambe	Umuziwabantu	Ray Nkonyeni
Agriculture	27%	9%	13%	52%
Mining	5%	6%	16%	73%
Manufacturing	21%	10%	8%	61%
Utilities	20%	9%	6%	66%
Construction	19%	11%	9%	6%
Retail trade	20%	12%	10%	59%
Transport	23%	10%	10%	58%
Business services	18%	10%	7%	65%
Social services	21%	11%	8%	60%
Government services	19%	11%	11%	58%
Total	21%	10%	10%	59%

3.3 POPULATION GROWTH SCENARIOS

Population and economic growth rates are used to determine future developmental requirements within the Ugu DM. This determines the required increase or decrease in water services. Non-domestic consumer unit growth, particularly commercial, industrial and agricultural growth, also gives an indication of the expected increase in water demand and associated wastewater flow discharges. Factors that affect population growth rate include:

- ✓ Immigration due to displaced farm labour, land restitution and declining job opportunities in neighbouring provinces;
- ✓ Emigration to urban centres or outward migration from the region in search of job opportunities; and
- ✓ The HIV/AIDS epidemic that is predicted to seriously affect economically active persons (18-45 years). Full-blown AIDS sufferers who are unable to continue working may return home to the rural areas. This may be an internal urban/rural shift, or migration from urban areas outside the DM. With the prevalence of HIV/AIDS, especially in KZN, it is important to ensure adequate water services provision in the rural areas.

There is currently 785 792 people within 216 781 households residing within 338 communities within Ugu DM. As mentioned earlier in Section 3.1, the Community Survey 2016 yielded a growth rate of 2.03% for the Ugu DM from 2011 to 2016. There seems to be some migration from the rural areas to the various urban centres in the district as well as where infrastructure is provided.

3.4 MAIN DEVELOPMENT NODES

The importance of development nodes is a reflection of an area's economic development potential and the range of service that should be provided. In terms of nodes, five types of nodes have been identified in the Ugu area of jurisdiction which are primary, secondary, tertiary, quaternary and rural service centre nodes.

- ✓ **Primary Node** - An urban centre with very high existing economic growth and the potential for expansion thereof. Provides service to the national and provincial economy. The identified primary node in the Ugu District Municipality area of jurisdiction is the Port Shepstone node.
- ✓ **Secondary Node** - An urban centre with good existing economic development and the potential for growth. Services the regional economy. Scottburgh and Harding have been identified as the secondary nodes in the Ugu District Municipality area of jurisdiction.
- ✓ **Tertiary Node** - A centre which should provide service to the sub-regional economy. The areas such as Port Edward, Margate, Hibberdene, Park Rynie and Umzinto have been identified as the tertiary nodes in the Ugu District Municipality area of jurisdiction.
- ✓ **Rural Service Centre** - A centre which should provide service to the localised rural economy. These centres include areas like Turton/Nyangwini, Dududu and Izingoloni and have been identified as the Rural Service Centres in the Ugu District Municipality area of jurisdiction.

4. WATER REQUIREMENTS

This section provides an overview of the water requirements as calculated using the demand model developed for the purpose of this study. A summary is provided firstly for the District and then for each of the Local Municipalities. The total number of households (HH) as obtained from the 2011 Census and the number of households below RDP standards are also provided. (Households below RDP standards include all households having water supply – any form – further than 200m from the household).

4.1 WATER SUPPLY SERVICE LEVEL

Service levels currently differ across the Ugu DM, predominantly based on a rural/urban split. In general urban areas have water services equal to or higher than, and many rural areas have either no water services or these services do not meet, the compulsory national standards determined by the Minister of Water Affairs and Forestry in terms of Section 9(1)(a) of the Water Services Act, 1997 (Table 4a).

Ugu has a free basic water policy that makes provision for the supply of 6kl of water per metered household per month. An Indigent Support Policy is also in place which applies to residential and non-profit organizations entitling the beneficiaries to 6kl of free water per household per month and 100% rebate on water and sanitation basic charges.

Ugu District municipality's indigent register has a total of 6 739 for water and 2 529 sanitation households and is reviewed on an annual basis. (IDP, 2019)

The Ugu DM WSDP 2018/2019 reports that the current water backlog for the District is as follows:

Table 4-1: Water Backlogs within Ugu District Municipality

Direct Backlogs	Totals
Direct settlement backlog water households. Total household of settlement with a water need (irrelevant the type of need)	78 408
Direct settlement backlog water population. Total population of settlement with a water need (irrelevant the type of need)	328 327

Source: Ugu DM WSDP, 2018-2019

According to the DWS reference framework database, the main source for the majority of households within Ugu DM is a communal stand pipes at a distance below 200m (approximately 33%). (DWS, 2019)

Table 4-2 overleaf presents the distribution of households by main source of water for drinking.

Table 4-2: Distribution of households by main source of water for drinking, DWS RF 2019

LM Name	Piped (tap) water inside the dwelling/house	Piped (tap) water inside yard	Distance below 200m	Distance greater than 200m	Borehole	Spring	Rain-water tank	Dam/pool/stagnant water	River/stream	Water vendor	Other	Total
Umdoni	8 911	6 921	14 253	8 105	688	42	301	0	4 783	1 281	0	45 285
Ray Nkonyeni	25 204	12 388	33 887	21 093	204	0	572	0	1 204	1 013	94	95 659
Umzumbe	714	9 563	13 034	14 644	1 801	51	12	0	11 418	2 101	68	53 406
Umuziwabantu	1 181	971	10 749	5 828	300	0	309	0	1 863	1 218	21	22 440
Total	36 010	29 843	71 923	49 670	2 993	93	1 194	0	19 268	5 613	183	216 790

Source: DWS Reference Framework, April 2019

The service levels for Ugu DM is depicted in **Figure 4-1** overleaf.

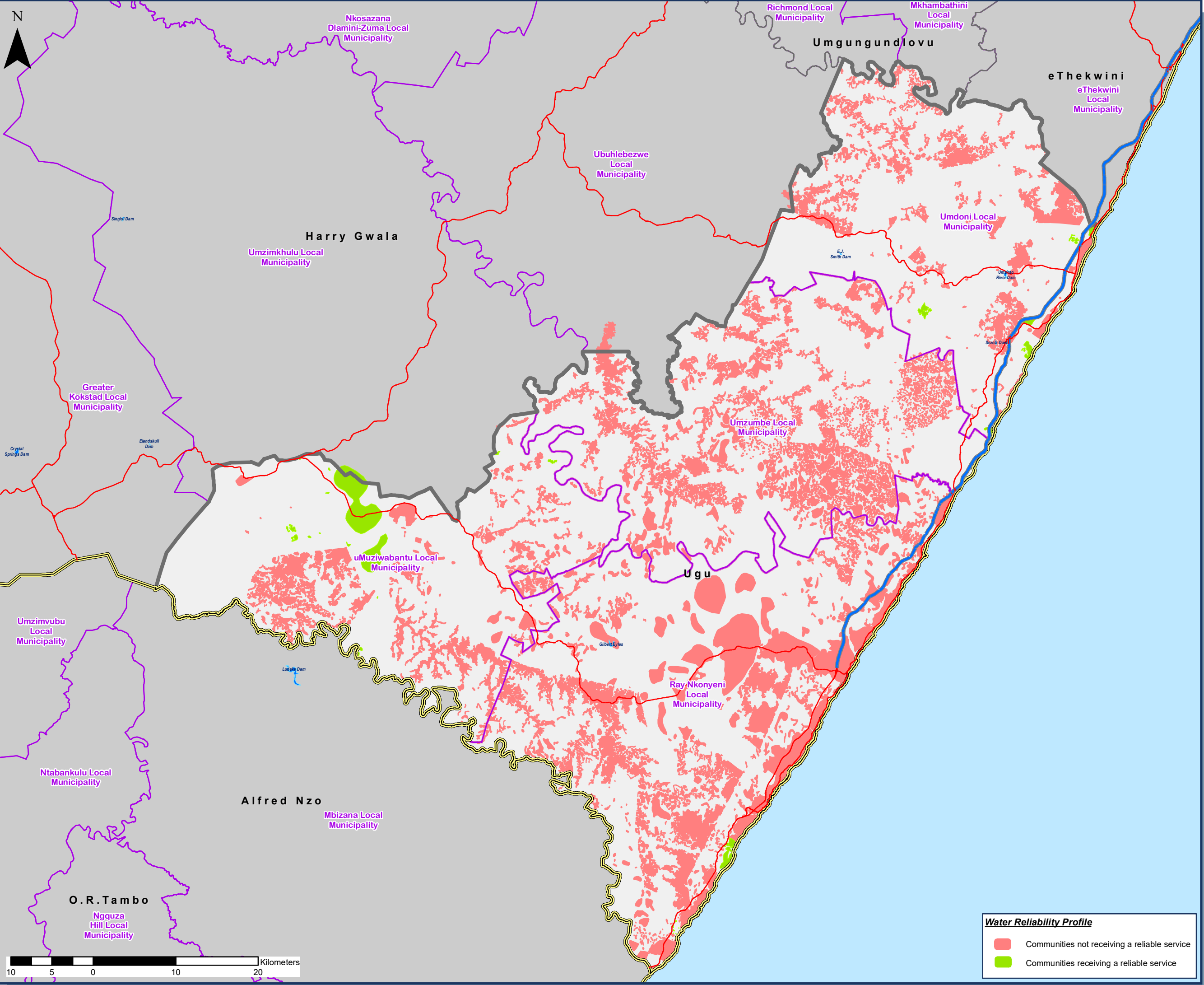

Legend

- Provincial Boundaries
- District Municipality Boundaries
- Local Municipality Boundaries
- National Roads
- Main Roads
- Dams & Dam Names
- Rivers
- Settlements
- Major Towns

LOCALITY:

CLIENT:

MUNICIPALITY:

UGU DISTRICT MUNICIPALITY

CONSULTANTS

Project No.: 27814

Mariswe
PO Box 25549, Monument Park
Pretoria, 0105

Tel: +27 (0) 12 424 9700
Fax: +27 (0) 12 460 4071
Email: pretoria@uwp.co.za

PROJECT TITLE

UGU DM: Universal Access Plan Phase III - Progressive Development of a Regional Concept Secondary Bulk Water Master Plan

MAP TITLE:

Water Supply Reliability Profile
UGU District Municipality

DATE COMPLETED: January 2021

MAP NO.: DC 21 Figure 4-1

Water Reliability Profile

- Communities not receiving a reliable service
- Communities receiving a reliable service



4.2 WATER LOSSES AND DEMAND MANAGEMENT⁴

The Ugu District Municipality recognised the need to focus on the reduction of NRW as part of its overall Water Conservation/Water Demand Management strategy as well as its contribution towards the objectives of the National WC/WDM initiatives currently underway throughout the country in support of the protection of a scarce water supply resource.

Non-Revenue Water (NRW) volumes within Ugu in the 2017/2018 financial year was determined to be 34.8% and urgent interventions are required to further reduce the levels of NRW through a number of differing approaches, either technical or non-technical in nature, which are targeting the reduction of physical leaks from an ageing reticulation network, or improving revenue streams from improved billing and metering practices. The high NRW of 34.8% for the 2017/2018 financial year for the thirteen (13) systems in Ugu is a direct loss of income for the municipality, which impacts directly on the O&M budget and the financial capability of the municipality.

The following was undertaken/implemented in order to reduce the NRW levels within the Ugu DM:

- ✓ Installation of a total of 152 pressure reducing valves (PRVs) of various sizes and types;
- ✓ Limited active leakage control activities;
- ✓ Establishment of district metered areas (DMA's);
- ✓ Construction of a leak detection and pressure management training facility;
- ✓ Installation of online loggers for meter reading at mostly outlying water treatment works;
- ✓ Consumer meter replacement – approximately 3 000; and
- ✓ Installation of intelligent PRV's.

The critical areas which the municipality needs to further focus to reduce NRW down to an economically acceptable level and to avoid regression, are the following:

- ✓ Active Leakage Control through specialised leak detection and repairs;
- ✓ District Meter data collection;
- ✓ DMAs monitoring tools;
- ✓ On-going maintenance of DMAs;
- ✓ Enforcement of By-Laws to deal with Illegal Connections;
- ✓ Water Conservation Campaigns for Community Awareness;
- ✓ Capacity Building;
- ✓ Wastewater Metering to achieve reliable water balancing;
- ✓ Intelligent bulk meter and DMA data acquisition;

⁴ Sourced from the Water Conservation and Demand Management Plan 2019 – 2023 for Ugu DM (Khamisi Med-Tech Engineers)

- ✓ Pressure Management and Advanced Pressure Management;
- ✓ War on Leaks;
- ✓ Meter Replacement and billing improvement; and
- ✓ Standpipe and Tanker point metering strategies.

4.3 WATER BALANCE

The WSA prepares monthly water balances, in the IWA format, on a local municipality level, for submission to the DWS. These water balances help provide a greater understanding of each of the supply systems/waterworks and also assist in the preparation of specific intervention strategies and cost/benefit calculations.

The latest available water balance for the WSA is presented in **Table 4-3** for the month of December 2018.

Table 4-3: Ugu DM Water Balance, December 2018

<p style="text-align: center;">Total System Input Volume 4 156 800 m³/month</p> <p style="text-align: center;">138.56 Mℓ/d</p>	<p style="text-align: center;">Authorised Consumption 2 761 846 m³/month Percentage of SIV = 66.4%</p> <p style="text-align: center;">92.06 Mℓ/d</p>	<p style="text-align: center;">Billed Authorised Consumption 2 249 097 m³/month Percentage of SIV = 54.1%</p>	<p style="text-align: center;">Billed Metered Consumption-Domestic 1 470 315 m³/month Percentage of SIV = 35.4%</p> <p style="text-align: center;">Billed Metered Consumption-Commercial - m³/month Percentage of SIV = 0.0%</p> <p style="text-align: center;">Export Volume - m³/month Percentage of SIV = 0.0%</p> <p style="text-align: center;">Billed Unmetered Consumption 778 782 m³/month Percentage of SIV = 18.7%</p>	<p style="text-align: center;">Revenue Water 2 249 097 m³/month Percentage of SIV = 54.1%</p> <p style="text-align: center;">74.97 Mℓ/d</p>	
		<p style="text-align: center;">Unbilled Authorised Consumption 512 749 m³/month Percentage of SIV = 12.3%</p> <p style="text-align: center;">17.09 Mℓ/d</p>	<p style="text-align: center;">Unbilled Metered Consumption 438 m³/month Percentage of SIV = 0.0%</p> <p style="text-align: center;">Unbilled Unmetered Consumption 512 311 m³/month Percentage of SIV = 12.3%</p>		<p style="text-align: center;">Non-Revenue Water 1 907 703 m³/month Percentage of SIV = 45.9%</p>
		<p style="text-align: center;">Water Losses 1 394 954 m³/month Percentage of SIV = 33.6%</p> <p style="text-align: center;">46.50 Mℓ/d</p>	<p style="text-align: center;">Apparent Losses 390 587 m³/month Percentage of SIV = 9.4%</p> <p style="text-align: center;">13.02 Mℓ/d</p>		
	<p style="text-align: center;">Real Losses 1 004 367 m³/month Percentage of SIV = 24%</p> <p style="text-align: center;">33.48 Mℓ/d</p>		<p style="text-align: center;">Mains and Distribution Leaks - m³/month Percentage of SIV = 0.0%</p> <p style="text-align: center;">Reservoir Overflows - m³/month Percentage of SIV = 0.0%</p> <p style="text-align: center;">Service Connection Leaks - m³/month Percentage of SIV = 0.0%</p>	<p style="text-align: center;">63.59 Mℓ/d</p>	

Source: KZN IWA Water Balances, 2018

The non-revenue water for the DM in 2018 was at 63.59 Mℓ/d. If using a rate of R6.00/kℓ, this amounts to a loss of R381 540 per day. Only 74.97 Mℓ/d of the SIV of 138.56 Mℓ/d can be billed and accounted for.

4.4 WATER DEMAND MODEL

This section provides an overview of the water requirements as calculated using the demand model developed for the purpose of this study. As mentioned in Section 1.5 of this report, the water demand model, approved by Umgeni Water, for this study was applied to determine the demands for all areas included in the study, at least at a town level. The water demands were modelled in five year increments up to 2050, with the minimum level of service as yard connections at 100ℓ capita per day. The base data used for the modelling is explained in Section 1.6.

The water demands for Ugu is presented below per LM and per supply scheme area. It must be noted that the Water Supply Scheme (WSS) boundaries do not necessarily coincide with municipal boundaries. There are supply areas that traverse more than one LM. The water requirements reported on are per LM and if a WSS is split by a LM, the water requirements are reported based on this split.

4.4.1 Water Demand for Ugu District Municipality

The water requirements (in Mℓ/d) for Ugu DM are presented per Local Municipality within **Table 4-4** below. These water requirements were calculated for consumers having formal water supply schemes and for consumers not yet supplied from a formal water supply scheme. Section 1.5 Water Demand Methodology in this report explains the approach for the calculations to determine the theoretical water requirements and adjusted for water losses. The Ugu DM would require 305.17 Mℓ/day by the year 2050.

The 2050 water requirements per LM are presented below in **Figure 4-2** in the form of a pie chart, illustrating that the Ray Nkonyeni LM will be the largest water consumer in the Ugu DM requiring 50% of all water.

Table 4-4: Water Requirements (Mℓ/d), per Local Municipality

LM	2050 Population	2020 (Mℓ/d)	2025 (Mℓ/d)	2030 (Mℓ/d)	2040 (Mℓ/d)	2045 (Mℓ/d)	2050 (Mℓ/d)
Umdoni	253 108	34.84	37.51	40.69	48.44	52.89	57.78
Umzumbe	273 302	30.71	33.08	35.93	42.87	46.88	51.30
Ray Nkonyeni	594 881	91.80	98.77	107.08	127.32	138.90	151.59
Umuziwabantu	229 573	26.61	28.68	31.15	37.19	40.67	44.50
Ugu DM	1 350 864	183.96	198.04	214.85	255.82	279.34	305.17

Figure 4-2: 2050 Water Demand in Mℓ/day per LM

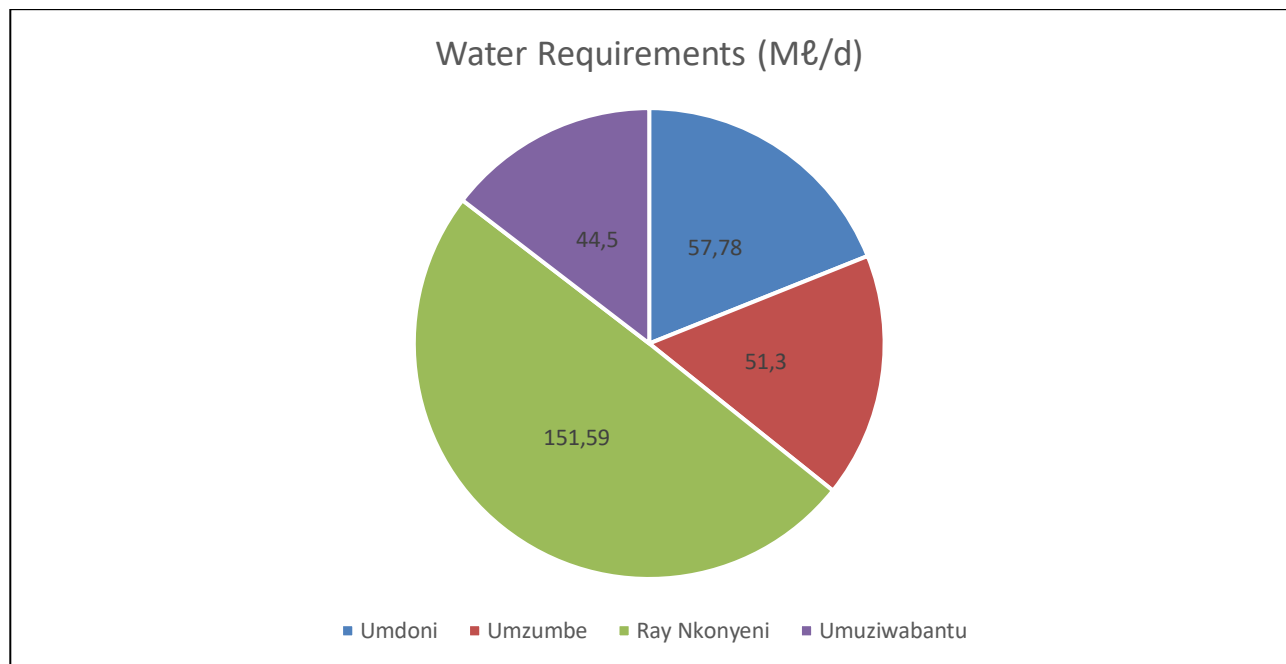

4.4.2 Demand per Regional Water Scheme

The water demands for the Water Supply Schemes (WSS) within Ugu DM is presented in **Table 4-5**.

Table 4-5: Ugu DM Water supply scheme demands

LM	WSS	2050 Population	2020 (Mℓ/d)	2025 (Mℓ/d)	2030 (Mℓ/d)	2040 (Mℓ/d)	2045 (Mℓ/d)	2050 (Mℓ/d)
Umdoni	Jolivet/Vulamehlo Water Supply Scheme - Cross Border	1 321	0.14	0.15	0.16	0.20	0.22	0.24
	KwaLembe Scheme	27 009	2.93	3.16	3.43	4.10	4.49	4.92
	Umgeni Water Scheme	25 846	3.17	3.42	3.71	4.43	4.84	5.30
	Vulamehlo Farming Scheme	14 772	1.62	1.75	1.90	2.26	2.47	2.70
	Vulamehlo Cross Border Scheme	39 204	4.44	4.78	5.20	6.22	6.81	7.45
	Umgeni Water Scheme	51 818	6.70	7.22	7.84	9.35	10.21	11.17
	uMtwalume Scheme	3 425	0.73	0.79	0.85	1.01	1.10	1.20
	uMzinto Scheme	108 288	19.14	20.58	22.30	26.48	28.87	31.47
Umzumbe	Hlokozi Water Supply Scheme	1 478	0.15	0.16	0.18	0.21	0.23	0.26
	Pungashe/Mhlabatshane Scheme	83 504	8.81	9.49	10.30	12.30	13.46	14.73
	uMtwalume Scheme	119 504	14.14	15.23	16.54	19.73	21.57	23.59
	uMzimkulu/Bhobhoyi Scheme	4 677	0.49	0.53	0.57	0.69	0.75	0.82
	Vulamehlo Farming Scheme	20 227	2.13	2.30	2.49	2.98	3.26	3.56
	KwaNdelu Scheme	23 946	2.50	2.70	2.93	3.50	3.83	4.19
	Vulamehlo Scheme	11 422	1.19	1.28	1.39	1.66	1.82	1.99

LM	WSS	2050 Population	2020 (Mℓ/d)	2025 (Mℓ/d)	2030 (Mℓ/d)	2040 (Mℓ/d)	2045 (Mℓ/d)	2050 (Mℓ/d)
	KwaHlongwa Scheme	11 169	1.20	1.29	1.40	1.67	1.83	2.01
	Vulamehlo Cross Border Scheme	43 609	4.58	4.93	5.36	6.40	7.00	7.67
Umuziwabantu	Mnqumeni (Future)	5 032	0.56	0.60	0.65	0.78	0.86	0.94
	Harding Weza Scheme	159 232	19.00	20.47	22.22	26.52	28.99	31.71
	KwaFodo Scheme	15 048	1.64	1.77	1.92	2.30	2.52	2.76
	KwaMbotho Scheme	25 887	2.84	3.06	3.33	3.98	4.36	4.77
Ray Nkonyeni	Harding Weza Scheme	29 405	3.14	3.38	3.67	4.39	4.80	5.26
	KwaNyuswa Scheme	17 899	1.93	2.08	2.26	2.70	2.96	3.24
	uMtamvuna Scheme	57 505	6.49	7.00	7.60	9.09	9.94	10.88
	uMzimkulu/Bhobhoyi Scheme	4 118	0.65	0.69	0.75	0.89	0.97	1.06
	Pungashe/Mhlabatshane Scheme	20 333	2.15	2.31	2.51	3.00	3.28	3.59
	uMtamvuna Scheme	159 315	19.67	21.19	23.01	27.46	30.02	32.83
	uMzimkulu/Bhobhoyi Scheme	351 368	62.58	67.27	72.87	86.49	94.26	102.76

5. EXISTING WATER SUPPLY INFRASTRUCTURE

This section provides an overview of the available water resources as well as the current surface water supplied schemes.

As indicated in the Water Service Development Plan the existing water infrastructure suggests that the formal urban coastal areas have well developed bulk infrastructure and networks and was historically the focus for infrastructure development in the DM. The coastal areas remain the highest concentration of the population and are also the main economic centres for the DM. Infrastructure development in the rural areas was historically done in a haphazard manner and this resulted in several stand-alone rural water schemes that are often supplied from unsustainable water sources.

The water supply to the District is derived from dams, rivers, ground water and bulk purchases from eThekweni and Umgeni Water. The water is then treated at several treatment plants, owned by Ugu before being distributed to households.

Umgeni Water operates the following bulk water infrastructure for the provision of potable water to Ugu District Municipality:

- ✓ **Storage Dams** - Nungwane Dam, Umzinto Dam and E.J. Smith Dam, Mhlabatshane Dam;
- ✓ **Water Treatment Plants (WTP)** - Amanzimtoti WTP, Umzinto WTP and Mtwalume WTP, Mhlabatshane WTP; and
- ✓ **Bulk Pipelines** - Nungwane Raw Water Aqueduct, South Coast Augmentation (SCA) Pipeline, South Coast Pipeline Phase 1 (SCP1), South Coast Pipeline Phase 2a.

For remote communities where no bulk services are feasible or possible (cannot be served by the Regional Scheme or Intermediate Schemes), a rudimentary water level of service is implemented in the form of boreholes with handpumps, or spring protections. In some areas a small reticulation scheme with RDP level of services will be constructed where possible.

5.1 WATER RESOURCE AVAILABILITY

5.1.1 Surface Water

The Ugu DM falls within the Mvoti to Mzimkhulu Water Management Area (WMA), which drains towards the East coast of South Africa. The Mvoti-Mzimkhulu WMA overlaps over the KwaZulu-Natal and the Eastern Cape Provinces. The WMA extends to Greytown in the North, Port Edward in the south, the Drakensberg Mountains in the west and the Indian Ocean in the east.

Ugu DM comprises of the following quaternary catchments: U10, U60, U70, U80, T40 and T50. The most prominent surface water resources in this WMA include the Lovu, Mdloi, Mngeni, Mkhomazi, Młazi,

Mtamvuna, Mtwalume, Mvoti and Mzimkhulu catchments. Other less prominent surface water resources include the Weza River and Phungashe/Mhlabatshane River, tributaries of the Umthamvuna and Umzumbe Rivers respectively. (UW IMP, 2020)

“The Eastern Region Internal Perspectives: Mvoti to Mzimkulu Water Management Area (WMA) Study” was completed and officially adopted by DWS in June 2004 and forms the basis for future water resources studies in the District. The findings of the study can be summarised in terms of the catchments of the main rivers in Ugu as follows:

- ✓ The Mlazi and Lovu catchments have surplus water available inclusive of the ecological reserve;
- ✓ The Mkhomazi catchment is stressed mainly due to large users abstracting water (SAPPI-SAICCOR industries) and the lack of storage in the river system;
- ✓ The South Coast catchment (Mzumbe, Mtwalume and Mpambanyoni Rivers) is experiencing a deficit (mostly during holiday peak season) that can be overcome with the provision of an off-channel storage;
- ✓ The Mtamvuna catchment is largely undeveloped with no major water users. The catchment has surplus water available and there is bulk infrastructure in place to supplement water supply to the South Coast areas; and
- ✓ The Mzimkulu catchment is a largely undeveloped catchment with high natural runoff and the potential therefore exists to develop the resource further. The catchment cannot supply the water demands during the dry periods and also meet the requirements of the Reserve. This is mainly due to the large number of people being dependant on run-of-river abstractions for their basic needs and the high requirements for the ecological component of the Reserve. Ncwabeni OCS Dam is proposed to overcome the shortfall in the DWS Feasibility Study 2012

The Mlazi and Lovu region is dominated by irrigation and afforestation, with irrigation being the main land use. The urban and peri-urban areas within this region are Richmond and Amanzimtoti which receive their water from boreholes, Beaulieu Dam as well as the Nungwane Dam.. The Mgeni System also supports the coastal area.

The U10 catchment, which is encompassed by the Mkhomazi River, is currently fairly undeveloped with the main land use activities being commercial forestry and irrigated areas in the central catchment areas around the towns of Bulwer, Richmond, Ixopo and Impendle. There is also a large industrial abstraction for Sappi Saiccor near the coastal town of Umkomaas.

The Middle South Coast region extends in a coastal strip from the uMkhomazi River southwards to the Mtwalume River. The region includes the Mzinto, Mpambanyoni, Mzumbe and Mtwalume river catchments in the U80 tertiary catchment. Whilst the region contains a number of rivers with significant runoff, no major impoundments exist in the region. The Umzinto supply system, which receives its water from the Umzinto WTP, includes the areas of Freeland Park, Hazelwood, Kelso, Pennington, Umzinto and Park Rynie. The

Mtwalume supply system receives water from the Mtwalume WTP and includes the areas of Elysium, Ifafa, Mtwalume and Sezela. Afforestation and irrigation are widespread in the region.

The Mtamvuna Region comprises of the tertiary catchment T40 (the Mtamvuna River and a few small coastal rivers to the north of it). The main water requirements within this area are domestic for both the urban and rural sectors. The urban requirements are from the coastal towns that include Margate, Ramsgate and Port Edward. Port Shepstone is situated in this region but is supplied with water from the Mzimkulu River. There are also large areas of afforestation and dryland sugar cane in the catchment.

The Mzimkulu Region comprises of the tertiary catchment T50. The main towns situated in the Mzimkulu Catchment are Underberg, Himeville, Creighton, Harding and Port Shepstone. The main land uses in the catchment are domestic, rural use, afforestation and irrigation. The Mzimkhulu River water demands are primarily from agriculture and afforestation; these are the largest water users in the system representing 31% and 41% of total water use respectively. The remaining demands are rural and urban demands, dryland sugar cane and stock watering, and invasive alien vegetation. (UW IMP, 2020)

Table 5-1 to Table 5-4 presents the yield information for the existing water resource infrastructure/developments in the various regions.

Table 5-1: Yield Information for the existing water resource developments in the M&azi/Lovu Region

Impoundment	River	Capacity (mcm)	Yield (Mm ³ /a)	Stochastic Yield (Mm ³ /a)	
			Historical	1:50	1:100
Nungwane Dam	Nungwane	2.24	2.2 (6.0 Mℓ/d)	3.6 (9.9 Mℓ/d)	3.3 (9.0 Mℓ/d)

Source: Umgeni Water, 2020

Table 5-2: Yields for the proposed Lower uMkhomazi BWSS (Ngwadini Dam)

Scenario	Time Slice	Support Releases	Ngwadini Dam Yield/Target (1:100)	
		(Smithfield to Ngwadini)	Mℓ/d	Mm ³ /a
Ngwadini Dam	2012	None	93	34
	2050 (Target Abstraction - 70 Mℓ/day)	Yes	70	26
	2050 (Target Abstraction - 95 Mℓ/day)	Yes	95	35
	2050 (Target Abstraction - 100 Mℓ/day)	Yes	150	55

Source: Umgeni Water, 2020

There are no current impoundments on the Mkhomazi River and all water abstracted from this resource is from run-of-river yield. There are, however, two (2) impoundments that will increase the yield of the system and allow for abstraction of water for treatment and potable use. The first is the Smithfield Dam and the second is the Ngwadini Off-channel Storage Dam. The Ngwadini Dam is to be constructed by Umgeni Water over the next six (6) years. The yield for this impoundment was determined as part of a water resources yield assessment undertaken for the uMkhomazi Water Project Feasibility Study.

Table 5-3: Yield Information for the existing water resource infrastructure in the Middle South Coast Region

Impoundment	River	Capacity (mcm)	Yield (Mm ³ /a)	Stochastic Yield (Mm ³ /a)	
			Historical	1:20	1:50
E.J. Smith Dam	Mzimayi	0.89	0.9 (2.5 Ml/day)	1.7 (4.7 Ml/day)	1.2 (3.3 Ml/day)
Umzinto Dam	uMuziwezinto	0.42	1.6 (4.4 Ml/day)	3.2 (8.8 Ml/day)	2.0 (5.6 Ml/day)
Mhlabatshane Dam	Mhlabatshane	1.5	Not Available	Not Available	1.5 (4.1 Ml/day)
Mtwalume (Run-of-River)	Mtwalume	-	-	3.0 (8.8 Ml/day)	2.7 (7.5 Ml/day)

Source: Umgeni Water, 2020

The significant infrastructure in the Middle South Coast Region include the existing impoundments of the Umzinto Dam on the uMuziwezinto (Mzinto) River, the E.J. Smith Dam on the Mzimayi River and the Mhlabatshane Dam on the Mhlabatshane River, a tributary of the Umzumbe River.

Table 5-4: Yield Information for the St Helen's Rock Abstraction site (Mzimkulu Region)

Site	River	Ecological Water Requirements	Present Day Yield (Mm ³ /a)
			Historical
St Helen's Rock	Mzimkulu	No	18.3 (50.1 Ml/day)
		Yes	3.3 (9 Ml/day)

Source: Umgeni Water, 2020

There are no major impoundments on the Mzimkulu River. The Gilbert Eyles Dam on a tributary of the Mzimkulu River is almost completely silted up. The northern part of the Lower South Coast Water Supply System (from Hibberdene to Ramsgate, including Port Shepstone) is presently supplied from a run-of-river abstraction on the Mzimkulu River. The water is abstracted at the St Helen's Rock (SHR) abstraction works near Port Shepstone and is further pumped to the Bhobhozi WTP (owned and operated by Ugu Municipality).

There are no impoundments on the Mtamvuna River. The only significant abstraction that occurs is a run-off-river facility owned and operated by Ugu DM to provide raw water to the Mtamvuna WTP. This plant supplies





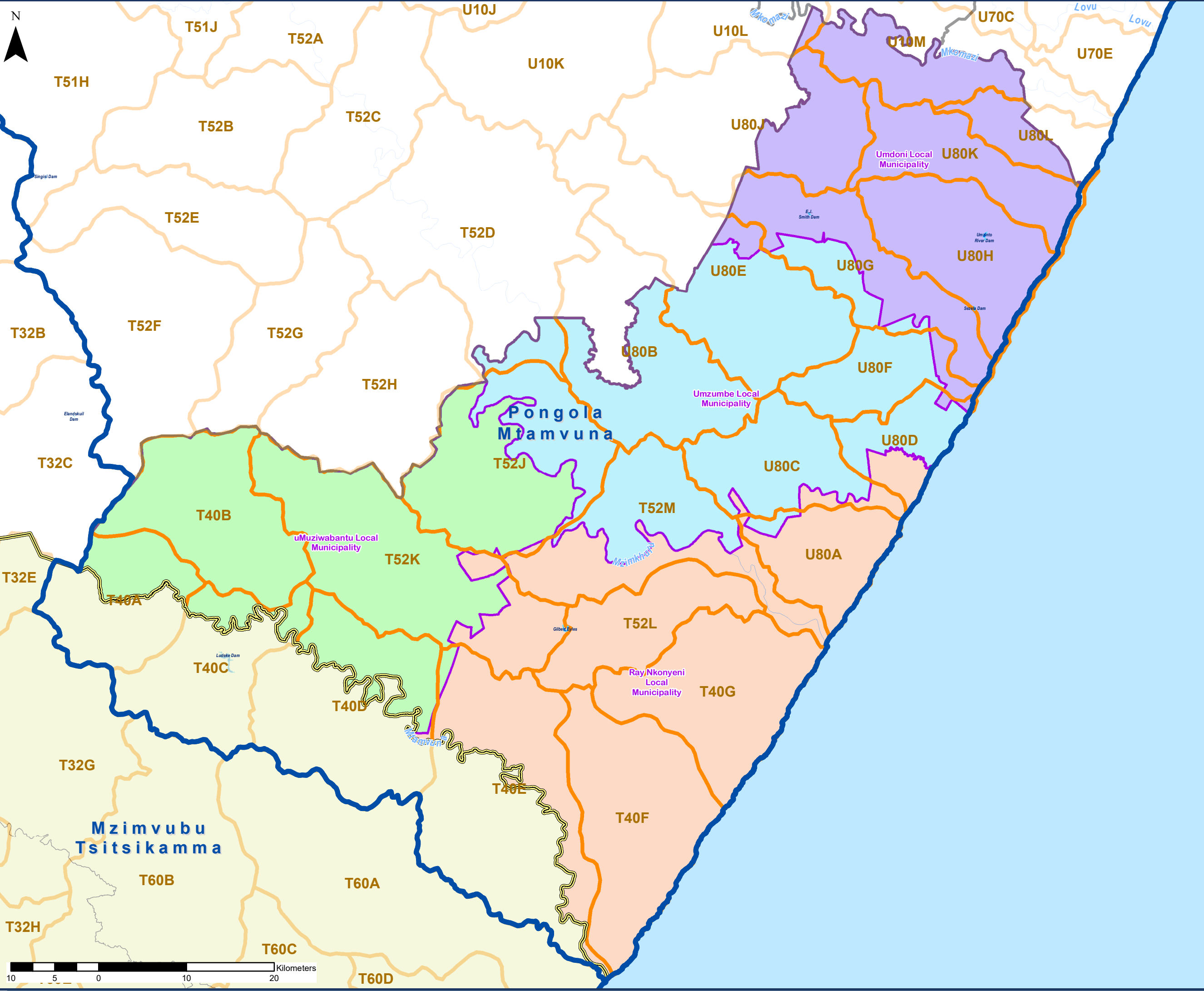

potable water south of Margate to Port Edward. The Mtamvuna abstraction works is located in the lower reaches of the Mtamvuna River.

Ground water is a largely undeveloped water resource and is available over the entire Water Management Area (WMA). It remains a valuable source of water supply especially in the rural areas. Where ground water is developed to supply water to communities at a large scale, the ground water levels should be carefully and continuously monitored to ensure sustainable use. At present the usage of ground water comprises only a small fraction (1%) of the fully sustainable annual recharge source of this area. Therefore further use could safely be made of this presently very under-utilised resource.

The water resources of Ugu DM is illustrated in **Figure 5-1** overleaf.



Legend

-  Provincial Boundaries
-  District Municipality Boundaries
-  Local Municipality Boundaries
-  Dams & Dam Names
-  Rivers
-  Water Management Area
-  Quaternary Boundaries & Numbers

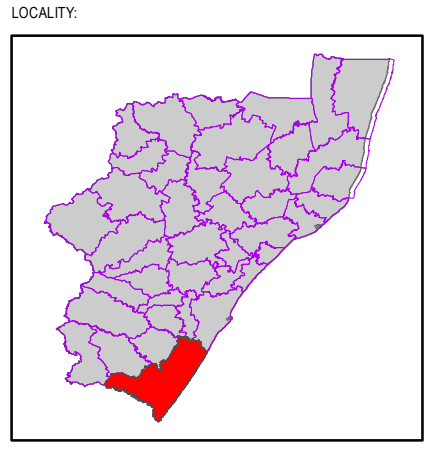

CLIENT:



MUNICIPALITY:



UGU DISTRICT MUNICIPALITY

CONSULTANTS



Project No.: 27814

Mariswe
PO Box 25549, Monument Park
Pretoria, 0105

Tel: +27 (0) 12 424 9700
Fax: +27 (0) 12 460 4071
Email: pretoria@uwp.co.za

PROJECT TITLE

UGU DM: Universal Access Plan Phase III - Progressive Development of a Regional Concept Secondary Bulk Water Master Plan

MAP TITLE:

Water Resources
UGU District Municipality

DATE COMPLETED: January 2021

MAP NO.: DC 21 Figure 5-1

5.2 PHYSICAL INFRASTRUCTURE

The existing water infrastructure within Ugu DM suggests that the formal, urban coastal areas have well developed bulk infrastructure and networks and historically was the focus for infrastructure development in the DM. The coastal areas remain the highest concentration of the population and are also the main economic centres for the DM. Infrastructure development in the rural areas was historically done in a haphazard manner and this resulted in several stand-alone rural water schemes that are often supplied from unsustainable water sources. (Ugu IDP, 2019)

A summary of the current major water infrastructure is shown in **Table 5-5** below.

Table 5-5: Major Water Infrastructure

Item	Quantity
Dams	5
Pipelines	≈ 4 300km
Reservoirs	153
Pump Stations	125
Water Treatment Works	18
Wastewater Treatment Works	17

Source: UGU IDP, 2019

According to the DWS Reference Framework, there are eleven major water supply areas in Ugu DM (depicted in **Figure 5-2**), namely:

- ✓ Umgeni Water Supply Scheme;
- ✓ uMzinto Water Supply Scheme;
- ✓ Mtwalume Water Supply Scheme;
- ✓ uMzimkhulu/Bhobhoyi Water Supply Scheme;
- ✓ uMtamvuna Water Supply Scheme;
- ✓ Harding/Weza Water Supply Scheme;
- ✓ KwaFodo Water Supply Scheme;
- ✓ Pungashe/Mhlabatshane Water Supply Scheme;
- ✓ KwaHlongwa/KwaNdelu Water Supply Scheme;
- ✓ Hlokozi/Vulamehlo Water Supply Scheme; and
- ✓ Greater Vulamehlo Water Supply Scheme.

Figure 5-2: Ugu Bulk Water Supply Areas as per DWS

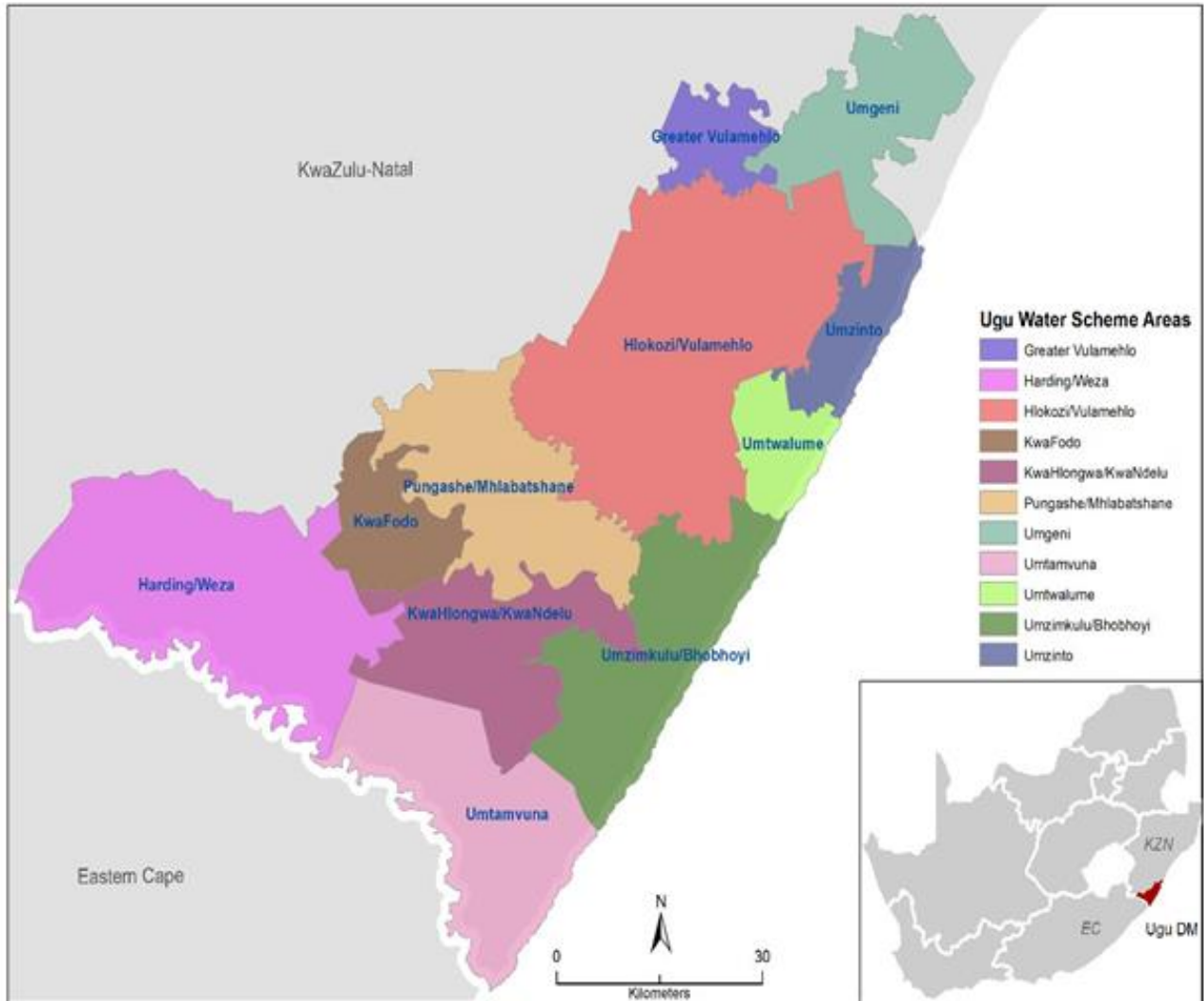

Apart from the Umgeni, uMzinto, uMtwalume and Mhlabatshane systems which are operated by Umgeni Water as the bulk water services provider, the majority of the systems are operated by Ugu DM.

Based on the UAP Phase II reconnaissance study, the DM was re-demarcated into 16 supply areas as per **Figure 5-3**. The water supply schemes and its respective infrastructure as per the study is discussed hereafter.

Figure 5-3: Ugu Bulk Water Supply Areas as per UAP Phase II

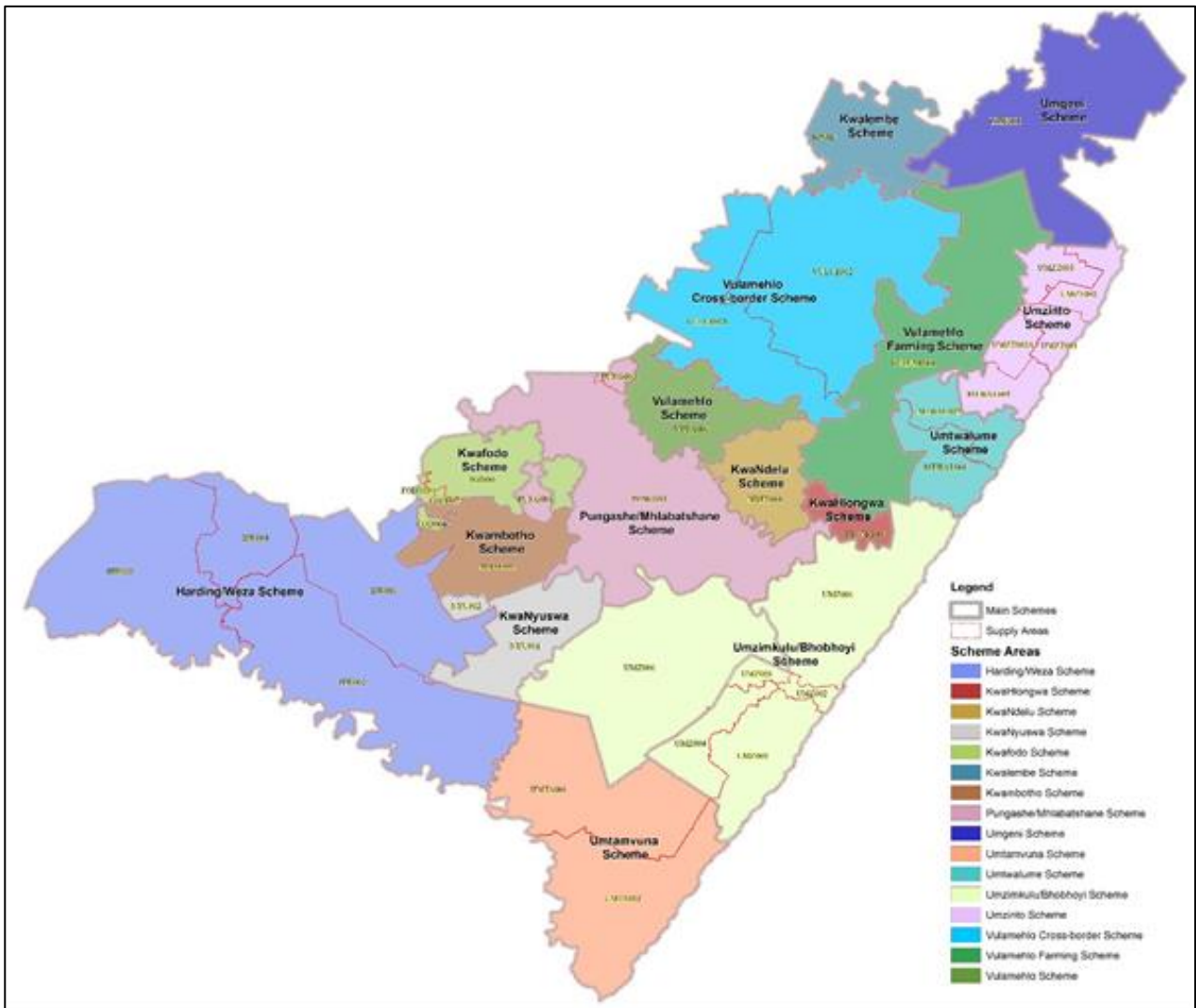

The existing scheme areas of Ugu are depicted in **Figure 5-4**.

5.2.1 Umgeni Water Supply Scheme

The Umgeni Water South Coast Pipeline (SCP) is the main source of supply and currently provides about 2 Ml/day to this Scheme area. This scheme serves the area in the north of Ugu DM and covers the areas on the northern side of Umdoni LM and includes the rural areas of kwaMaphumulo, Nkwali, Mfume and Vulindlela. The treated water from Umgeni Water is received via metered connections and thereafter the service is owned and operated by the Ugu DM.

5.2.2 uMzinto Water Supply Scheme

The uMzinto Supply Scheme abstracts and treats water for the areas referred to as the Upper South Coast, including Renishaw, Scottburgh, Park Rynie, Sezela, Umzinto and Ifafa. The scheme has also been extended to supply further inland areas including kwaCele, Amandawe and farming areas with a pipeline also supplying Dududu.

Table 5-6 below summarises the infrastructure of the uMzinto WSS.

Table 5-6: Bulk Water Infrastructure (uMzinto WSS)

Raw Water Source	Lawful Availability (Mm ³ /a)	Yield (Mℓ/Day)
EJ Smith Dam	4.4	8.9
uMzinto Dam		
WTP	Existing Capacity (Mℓ/day)	
uMzinto		13.6
Bulk Supply Pipeline	Diameter (mm)	Length (m)
uMzinto WTP to Cabana Res	250	3 882
	200	2 089
	100	7 583
Between WTP & Cabana T off to Kelso	125	821
	100	377
uMzinto WTP to T off to uMzinto heights	225	2 848
	150	5 060
	75	721
Reservoir	Storage (Mℓ)	
Hazelwood		0.68
Nkonka		5
Umzinto Height		5
Freeland Park		2.3
Scottburgh South		5.25
Scottburgh central		2.71
Ellingham		2
Park Rynie		0.9
Esperanza		0.3
2*Ifafa		1
2*Malangeni		Not available
Cabana		1
Kelso		0.5
Pennington		3
Umdoni		1
Hilton		2
Bazley		1

Source: UAP Phase II

5.2.3 Mtwalume Water Supply Scheme

The uMtwalume Water Supply Scheme abstracts and treats water for the areas usually referred to as the Middle South Coast, including Bazley, Elysium, Ifafa, parts of Kelso and uMtwalume along the coast and inland areas including the rural areas of Mathulini and kwaQoloqolo.

Table 5-7 below summarises the infrastructure of the Mtwalume WSS.

Table 5-7: Bulk Water Infrastructure (Mtwalume WSS)

Raw Water Source	Lawful Availability (Mℓ/day)	Yield (Mℓ/Day)
uMtwalume River	8.7	7.5
WTP	Existing Capacity (Mℓ/day)	Proposed Capacity (Mℓ/day)
uMtwalume	13.6	
Bulk Supply Pipeline	Diameter (mm)	Length (m)
uMtwalume WTP to Ellysium Reservoir	225	2 329
Ellysium Reservoir Mtwalume Res	150	5 469
Mtwalume Res to Koelwaters Res	100	1 468
Mtwalume WTP to Mnafu Reservoir	250	4 553
Mnafu Reservoir to Mathulini Res	350	3 572
Mtwalume WTP to Magwaza Reservoir	100	8 120
Magwaza Reservoir to Inkonxe	100	4 615
Reservoir	Storage (Mℓ)	Upgrade (Additional Storage Required) Mℓ
Inkonxe	0.5	-
Magwaza	0.5	-
Ellysium	5.5	-
Mathulini	0.5	-
Mnafu	3	-
Koelwaters	1	-
Mtwalume	0.25	-

Source: UAP Phase II

5.2.4 uMzimkhulu/Bhobhoi Water Supply Scheme

The uMzimkhulu/Bhobhoi Supply Scheme abstracts and treats water from the uMzimkhulu River for the areas covering parts of the Lower South Coast, from Hibberdene in the north to Ramsgate in the south. Inland it extends to supply areas that include Gamalakhe, Murchison, kwaMavundla, Loisia and kwaMadlala.

Table 5-8 overleaf summarises the infrastructure of the uMzimkhulu/Bhobhoi WSS.

Table 5-8: Bulk Water Infrastructure (uMzimkhulu/Bhobhoi WSS)

Raw Water Source	Lawful Availability (Mℓ/day)	Yield (Mℓ/Day)
uMzimkhulu River	31.4	50.1
WTP	Existing Capacity (Mℓ/day)	Proposed Capacity (Mℓ/day)
uMzimkhulu WTP	54 being upgraded to 81Mℓ/day (2017)	
Bulk Supply Pipeline	Diameter (mm)	Length (m)
uMzimkhulu WTP to Murchisonno.2	200	2 493
Murchison no.2 - Murchison no.3	200	3 367
Murchison no.3 - Murchison no.4	200	1 414
Murchison no.2 – Murchison hospital	200	5 876
uMzimkhulu WTP to Bomela North	264	5 348
uMzimkhulu WTP to Betania	315	1 831
Betania to Gamalakhe A	315	8 168
Gamalakhe A to Gamalakhe tower	300	1 393
uMzimkhulu WTP tees off to Izotsha	600	5 684
uMzimkhulu WTP to Sport field BPT	600	8 890
uMzimkhulu WTP tees off Shelly 1 & 2	375 200 100	5 740 759 1 278
uMzimkhulu WTP tees off to uMzimkhulu 36 & 36A	400 300 264	3 415 3 289 3 291
Reservoir	Storage (Mℓ)	Upgrade (Additional Storage Required) Mℓ
Nosita	2.5	-
Kaisers	1	-
Sea slope A&B	9.54	-
Ramsgate South	2.5	-
Ramsgate North	2.5	-
Margate 2A &2B	9.5	-
Barrow green	3.4	-
Res 12A	4.5	-
UMzimkhulu 36/36A	7.27	-
Upper Marburg	10	-
Masinege	2	-
Esperanza	1	-
Abersville	10	-
Uvongo	2.5	-
Shelly beach 1&2	7.5	-
Catalina	2.5	-
Lower Woodgrange	1.14	-
Woodgrange	4.54	-
Melville	4.5	-
Anerley	2.5	-

Source: UAP Phase II

5.2.5 uMtamvuna Water Supply Scheme

The uMtamvuna Supply Scheme abstracts and treats water from the uMtamvuna River for the areas that include the inland areas of Hibiscus Coast LM, kwaXolo, MkwaShoba/Mdlazi, and kwaShobeni and coastal strip areas from Ramsgate to Port Edward.

Table 5-9 below summarises the infrastructure of the uMtamvuna WSS.

Table 5-9: Bulk Water Infrastructure (uMtamvuna WSS)

Raw Water Source	Lawful Availability	Yield (Mℓ/Day)
UMtamvuna River		33Mℓ/day (Estimated)
WTP	Existing Capacity (Mℓ/day)	Proposed Capacity (Mℓ/day)
uMtamvuna WTP	30	
Bulk Supply Pipeline	Diameter (mm)	Length (m)
uMtamvuna WTP to Florida	400	3000
Florida – Shoba	150	10 000
Florida – Izingolweni	200	14 000
uMtamvuna WTP to BP01	397.4	12 406
Reservoir	Storage (Mℓ)	Upgrade (Additional Storage Required) Mℓ
Eziqoleni Reservoirs	4.5	-
BP1	5	-
BPT	5	-
BP 2	5	-
Bromsgrove	2	-
Leisure bay	2.5	-
New banners nest	1	-
Upper banners nest 1 &2	0.34	-
South broom	2.5	-
Sanlameer	2.5	-

Source: UAP Phase II

5.2.6 Harding/Weza Water Supply Scheme

The Harding/Weza Water Supply Scheme abstracts and treats water from the Weza River and the Harding Dam. The scheme supplies the rural areas of KwaMachi, kwaJali, kwaMthimude and the town of Harding. Progressively, the scheme has also been extended to incorporate the areas of kwaMbotho and kwaFodo. It is the plan that the existing kwaFodo, kwaMbotho and kwaNyuswa WTP's will be decommissioned for supply from the Harding/Weza WTP.

Table 5-10 overleaf summarises the infrastructure of the Harding/Weza WSS.

Table 5-10: Bulk Water Infrastructure (Harding/Weza WSS)

Raw Water Source	Lawful Availability	Yield (Mℓ/Day)
Weza and Amanzimnyama (Harding) Dam		5.2
WTP	Existing Capacity (Mℓ/day)	Proposed Capacity (Mℓ/day)
Planned Weza WTP	3.6	11.8
Bulk Supply Pipeline	Diameter (mm)	Length (m)
Weza/New Harding WTP to Jali	150	6 284
Jali to Bazini	100	1 225
Weza/New Harding WTP to Ikwezi A & B	200 350	5 242
Ikwezi to Machi	200	1 0901
Machi to Elim	200	15 016
Elim to Młozane	200	2 622 12 587
Ikwezi to Harding WTP	200	4 421
Harding WTP to kwaFodo	200 250	3500 5800
kwaFodo to kwaFodo 1/Mbotho	160	3 990
KwaFodo to kwaFodo north 1	160	12 194
kwaFodo north 1 to kwaFodo north 1	160	850
Reservoir	Storage (Mℓ)	Upgrade (Additional Storage Required) Mℓ
Ikwezi	11	-
Jali	2 x 1Mℓ	-
Machi	1	-
Bazini	0.1	-
Elim	5.5	-
Młozane	0.5	-
Kwafoda	0.1	-
Kwafodo North 1	0.1	-
Kwafodo North 2	0.05	-
Kwambotho	0.55	-

Source: UAP Phase II

5.2.7 KwaMbotho Water Supply Scheme

The kwaMbotho Supply Scheme abstracts and treats water from the Ncekete River for the supply to the rural areas of kwaMbotho.

Table 5-11 summarises the infrastructure of the kwaMbotho WSS.

Table 5-11: Bulk Water Infrastructure (kwaMbotho WSS)

Raw Water Source	Lawful Availability	Yield (Mℓ/Day)
KwaMbotho Stream	-	-
WTP	Existing Capacity (Mℓ/day)	Proposed Capacity (Mℓ/day)
KwaMbotho WTP	-	-
Bulk Supply Pipeline	Diameter (mm)	Length (m)
KwaMbotho WTP split to Isitebele 4 Res	160 110	3 086 5 495
KwaMbotho WTP to kwaFodo Res	160	2 430
KwaMbotho WTP to Santomba G Res	160	6 710
Reservoir	Storage (Mℓ)	Upgrade (Additional Storage Required) Mℓ
KwaFodo	0.55	-
Isitebele	0.12	-
Santomba	-	-
KwaMbotho 2	0.12	-
Kwanonkala 3	0.2	-
BPT	-	-

Source: UAP Phase II

5.2.8 KwaFodo Water Supply Scheme

The kwaFodo Supply Scheme abstracts and treats water from the Cekeza River for the supply to the rural areas of kwaFodo.

Table 5-12 summarises the infrastructure of the kwaFodo WSS.

Table 5-12: Bulk Water Infrastructure (kwaFodo WSS)

Raw Water Source	Lawful Availability	Yield (Mℓ/Day)
Cekeza River	-	-
WTP	Existing Capacity (Mℓ/day)	Proposed Capacity (Mℓ/day)
kwaFodo WTP	-	-
Bulk Supply Pipeline	Diameter (mm)	Length (m)
KwaFodo South 2 to Kwafodo WTP	100	2 210
KwaFodo WTP to Santomba A	100	1 330
Santomba A to Res	100	3 380
KwaFodo WTP to BPT1	100	1 803
KwaFodo WTP to BPT2	100	2 110
BPT2 to Res	100	2 170
Reservoir	Storage (Mℓ)	Upgrade (Additional Storage Required) Mℓ
BPT	0.03	-
kwaFodo South 2	0.05	-
BPT	0.03	-
Santomba A	0.1	-

Source: UAP Phase II

5.2.9 KwaNyuswa Water Supply Scheme

The kwaNyuswa Supply Scheme abstracts and treats water from a local river for the supply to the areas of kwaNyuswa.

Table 5-13 summarises the infrastructure of the kwaNyuswa WSS.

Table 5-13: Bulk Water Infrastructure (kwaNyuswa WSS)

Raw Water Source	Lawful Availability	Yield (Mℓ/Day)
River	-	-
WTP	Existing Capacity (Mℓ/day)	Proposed Capacity (Mℓ/day)
KwaNyuswa WTP: 2		
Bulk Supply Pipeline	Diameter (mm)	Length (m)
KwaNyuswa WTP2 to kwaNyuswa A Reservoirs	160	2 778
kwaNyuswa A to Res	100	1 391
kwaNyuswa A to 2 x Res	160	5 063
	110	1 487
	90	384
	75	415
	63	1 139
	50	1 813
2 x Res to kwaNyuswa Res	200	3 820
KwaNyuswa WTP1 to kwaNyuswa Res	-	2 530
Reservoir	Storage (Mℓ)	Upgrade (Additional Storage Required) Mℓ
2*KwaNyuswa	0.6	-
2*res	0.4	-
KwaNyuswa res A	0.4	-

Source: UAP Phase II

5.2.10 Pungashe/Mhlabatshane Water Supply Scheme

The Pungashe/Mhlabatshane Supply Scheme abstracts and treats water from the Mhlabatshane Dam. The dam and the WTP are owned by Umgeni Water while Ugu DM owns and operates infrastructure downstream of the WTP.

Table 5-14 overleaf summarises the infrastructure of the Pungashe/Mhlabatshane WSS.

Table 5-14: Bulk Water Infrastructure (Pungashe/Mhlabatshane WSS)

Raw Water Source	Lawful Availability	Yield (Mℓ/Day)
Mhlabatshane Dam	-	4.4
WTP	Existing Capacity (Mℓ/day)	Proposed Capacity (Mℓ/day)
Phungashe WTP	4.4	-
Bulk Supply Pipeline	Diameter (mm)	Length (m)
Phungashe WTP to Ndwebu	160	3 467
Phungashe WTP to Phungashe WTP balancing tank	160	1 020
Phungashe WTP balancing tank to Pungashe Res	160	3 611
From Pungashe Res T off to Res	160	650
From Res Toff to Pungashe village Res	400	300
Pungashe village to Nomagetje	400	1 660
Nomagetje to kwaPhongolo	400	4 770
From kwaPhongolo T off to kwaNcengesi	450 400 350	987 2 157 2 286
From kwaNcengesi T to St Faith	430	8 000
St Faith to Mehломnyama	350	12 991
From Mehломnyama split to Qwabe	160	11 167
To Enkulu	160	1 270
Enkulu to Frank lands	160	2 533
Reservoir	Storage (Mℓ)	Upgrade (Additional Storage Required) Mℓ
Ndwebu	0.6	-
Pungashe WTP balancing tank		-
Pungashe res	0.5	-
Res	2	-
Pungashe Village	0.6	-
Nomagetje	0.25	-
kwaPhongolo*2	1.9	-
St. Faiths Res	2.5	-
Mehломnyama*2	0.75	-
Qwabe	0.25	-
Enkulu	0.5	-
Frankland	1	-
Kwancengesi	0.2	-

Source: UAP Phase II

5.2.11 KwaNdelu Water Supply Scheme

The kwaNdelu Supply Scheme abstracts and treats water from the Mzambe River for the supply to the rural areas of kwaNdelu.

Table 5-15 overleaf summarises the infrastructure of the kwaNdelu WSS.

Table 5-15: Bulk Water Infrastructure (kwaNdelu WSS)

Raw Water Source	Lawful Availability	Yield (Mℓ/Day)
Ndelu River	-	4.4
WTP	Existing Capacity (Mℓ/day)	Proposed Capacity (Mℓ/day)
Ndelu WTP	1.4	
Bulk Supply Pipeline	Diameter (mm)	Length (m)
Ndelu WTP to Stone Hill	200	1 974
Stone Hill to Ixobho	200	5 030
Ixobho to Odeke 1	160	1 458
Odeke 1 to kwaHlaba	110	4 330
Reservoir	Storage (Mℓ)	Upgrade (Additional Storage Required) Mℓ
Stone hill	0.1	-
Ixobho	0.5	-
Odeke res 1	0.1	-
Kwahlaba	0.2	-
Stone hill	0.1	-

Source: UAP Phase II

5.2.12 Vulamehlo Water Supply Scheme

The Vulamehlo Scheme distributes water from an extension of the Ndelu Water Scheme for the supply to the rural areas of Vulamehlo.

5.2.13 kwaHlongwa Water Supply Scheme

The kwaHlongwa Scheme abstracts, treats and distributes water from an extension of the kwaMalukaka River for the supply to the rural areas of kwaHlongwa.

Table 5-16 summarises the infrastructure of the kwaHlongwa WSS.

Table 5-16: Bulk Water Infrastructure (kwaHlongwa WSS)

Raw Water Source	Lawful Availability	Yield (Mℓ/Day)
kwaMalukaka River	-	-
WTP	Existing Capacity (Mℓ/day)	Proposed Capacity (Mℓ/day)
KwaHlongwa WTP	-	-
Bulk Supply Pipeline	Diameter (mm)	Length (m)
KwaHlongwa WTP to Molukhakha	150	1 710
Molukhakha to uMgubo	100	1 790
Reservoir	Storage (Mℓ)	Upgrade (Additional Storage Req'd) Mℓ
Molukhakha	0.5	-
uMgubo	0.1	-

Source: UAP Phase II

5.2.14 Vulamehlo Cross Border Water Supply Scheme

The Vulamehlo Cross Border Scheme abstracts, treats and distributes water from the Upper Mtwalume River for the supply to the areas of Jolivet, Hlokozi, Nyavini and Braemar in the Harry Gwala DM and Ugu DM.

Table 5-17 summarises the infrastructure of the Vulamehlo Cross Border WSS.

Table 5-17: Bulk Water Infrastructure (Vulamehlo Cross Border WSS)

Raw Water Source	Lawful Availability	Yield (Mℓ/Day)
uMtwalume River	-	1.6
WTP	Existing Capacity (Mℓ/day)	Proposed Capacity (Mℓ/day)
Vulamehlo Cross Border	4.5	-
Bulk Supply Pipeline	Diameter (mm)	Length (m)
Vulamehlo WTP to Nyavini Reservoir No. 1	150	3 140
Vulamehlo WTP to Hluthankungu Reservoir	150	3 160
Reservoir	Storage (Mℓ)	Upgrade (Additional Storage Required) Mℓ
Res A2	0.2	-
Hluthankungu	2	-
Res B1	0.25	-
Jolivet res	0.15	-
Hluthankungu Res A	2	-
Res A3	0.2	-
Res A4	0.2	-
Res A5	0.2	-
Res A6	0.2	-
Res A7	0.2	-
Res A8	0.2	-
Res A9	0.2	-
Res A9	0.05	-
Res A10	0.2	-
Res A11	0.25	-
Breamer	0.25	-
uMgaye	2.5	-
Res	N/A	-
BPT	N/A	-
kwaNkosi	0.5	-
Nyavini	0.5	-

Source: UAP Phase II

5.2.15 Vulamehlo Farming Water Supply Scheme

The Vulamehlo Farming Supply Scheme covers the farming areas in the Vulamehlo LM. This area currently benefits from privately owned stand-alone schemes and supplies from neighbouring schemes such as uMzinto WSS.

5.2.16 KwaLembe Water Supply Scheme

The kwaLembe Water Supply Scheme abstracts and treats water from the Mkomaas River for the supply to the rural areas of kwaLembe.

Table 5-18 below summarises the infrastructure of the kwaLembe WSS.

Table 5-18: Bulk Water Infrastructure (kwaLembe WSS)

Raw Water Source	Lawful Availability	Yield (Mℓ/Day)
Mkomaas	-	46
WTP	Existing Capacity (Mℓ/day)	Proposed Capacity (Mℓ/day)
Kwalembe WTP	1.4	-
Bulk Supply Pipeline	Diameter (mm)	Length (m)
Kwalembe WTP to Res	N/A	2 301
Res to Ntabeskopo	N/A	3 911
Ntabeskopo to Kwaqiko	N/A	11 376
Reservoir	Storage (Mℓ)	Upgrade (Additional Storage Required) Mℓ
Ntabeskopo	N/A	-
Kwaqiko Res 1	0.2	-

Source: UAP Phase II

Figure 5-4 presents the existing infrastructure of the DM and then per LM within **Figures 5-5 to 5-8**.

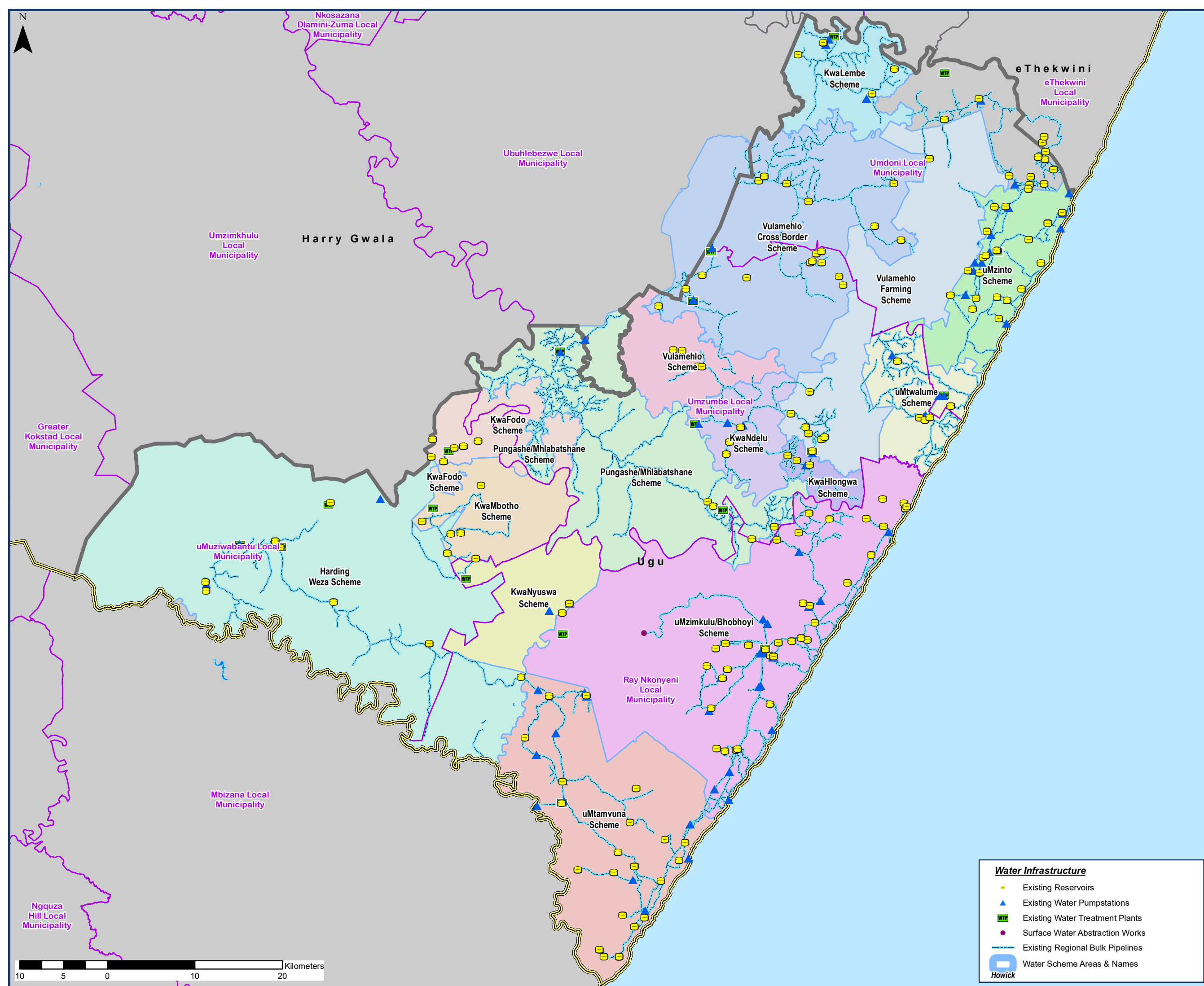

Legend

- Provincial Boundaries
- District Municipality Boundaries
- Local Municipality Boundaries
- National Roads
- Main Roads
- Dams & Dam Names
- Rivers
- Settlements
- Major Towns

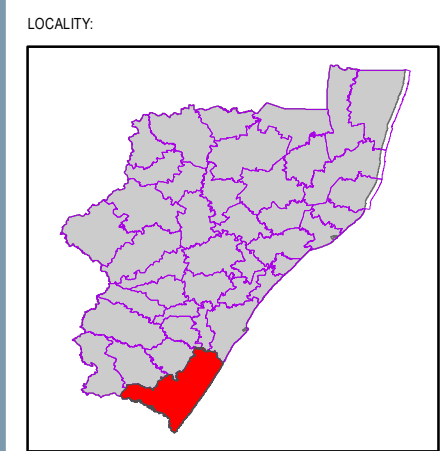

CLIENT:

MUNICIPALITY:

CONSULTANTS

Project No.: 27814

Mariswe
PO Box 25549, Monument Park
Pretoria, 0105

Tel: +27 (0) 12 424 9700
Fax: +27 (0) 12 460 4071
Email: pretoria@uwp.co.za

PROJECT TITLE

UGU DM: Universal Access Plan Phase III - Progressive Development of a Regional Concept Secondary Bulk Water Master Plan

MAP TITLE:

Existing Scheme Areas & Infrastructure Components UGU District Municipality

DATE COMPLETED:

January 2021

MAP NO.:

DC 21 Figure 5-4

Water Infrastructure

- Existing Reservoirs
- Existing Water Pumpstations
- Existing Water Treatment Plants
- Surface Water Abstraction Works
- Existing Regional Bulk Pipelines
- Water Scheme Areas & Names

Howick





Harry Gwala

Ubuhlebezwe Local Municipality

Umzimkhulu Local Municipality

Umdoni Local Municipality

Umzambe Local Municipality

KwaFodo Scheme

Vulamehlo Scheme

uMtwalume Scheme

Pungashe/Mhlabatshane Scheme

Ugu

KwaNdelu Scheme

KwaFodo Scheme









Pungashe/Mhlabatshane Scheme

KwaHlongwa Scheme

uMuziwabantu Local Municipality

Ray Nkonyeni Local Municipality

Legend

-  Provincial Boundaries
-  District Municipality Boundaries
-  Local Municipality Boundaries
-  National Roads
-  Main Roads
-  Dams & Dam Names
-  Rivers
-  Settlements
-  Major Towns

LOCALITY:

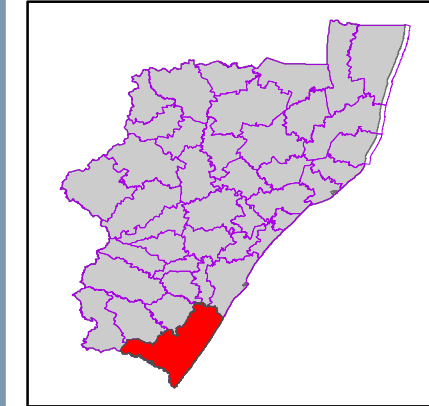

CLIENT:



MUNICIPALITY:



CONSULTANTS

Project No.: 27814



Mariswe
PO Box 25549, Monument Park
Pretoria, 0105

Tel: +27 (0) 12 424 9700
Fax: +27 (0) 12 460 4071
Email: pretoria@uwp.co.za

PROJECT TITLE

UGU DM: Universal Access Plan Phase III - Progressive Development of a Regional Concept Secondary Bulk Water Master Plan

MAP TITLE:

Existing Scheme Areas & Infrastructure Components - Umzambe UGU District Municipality







DATE COMPLETED:

January 2021

MAP NO.:

DC 21 Figure 5-6

Water Infrastructure









-  Existing Reservoirs
-  Existing Water Pumpstations
-  Existing Water Treatment Plants
-  Surface Water Abstraction Works
-  Existing Regional Bulk Pipelines
-  Water Scheme Areas & Names

Howick





Legend

-  Provincial Boundaries
-  District Municipality Boundaries
-  Local Municipality Boundaries
-  National Roads
-  Main Roads
-  Dams & Dam Names
-  Rivers
-  Settlements
-  Major Towns

LOCALITY:

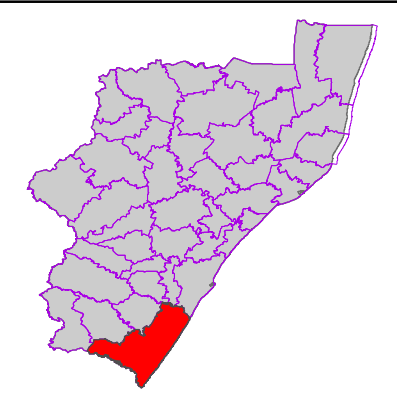

CLIENT:



MUNICIPALITY:



CONSULTANTS



Project No.: 27814

Mariswe
PO Box 25549, Monument Park
Pretoria, 0105

Tel: +27 (0) 12 424 9700
Fax: +27 (0) 12 460 4071
Email: pretoria@uwp.co.za

PROJECT TITLE

UGU DM: Universal Access Plan Phase III - Progressive Development of a Regional Concept Secondary Bulk Water Master Plan





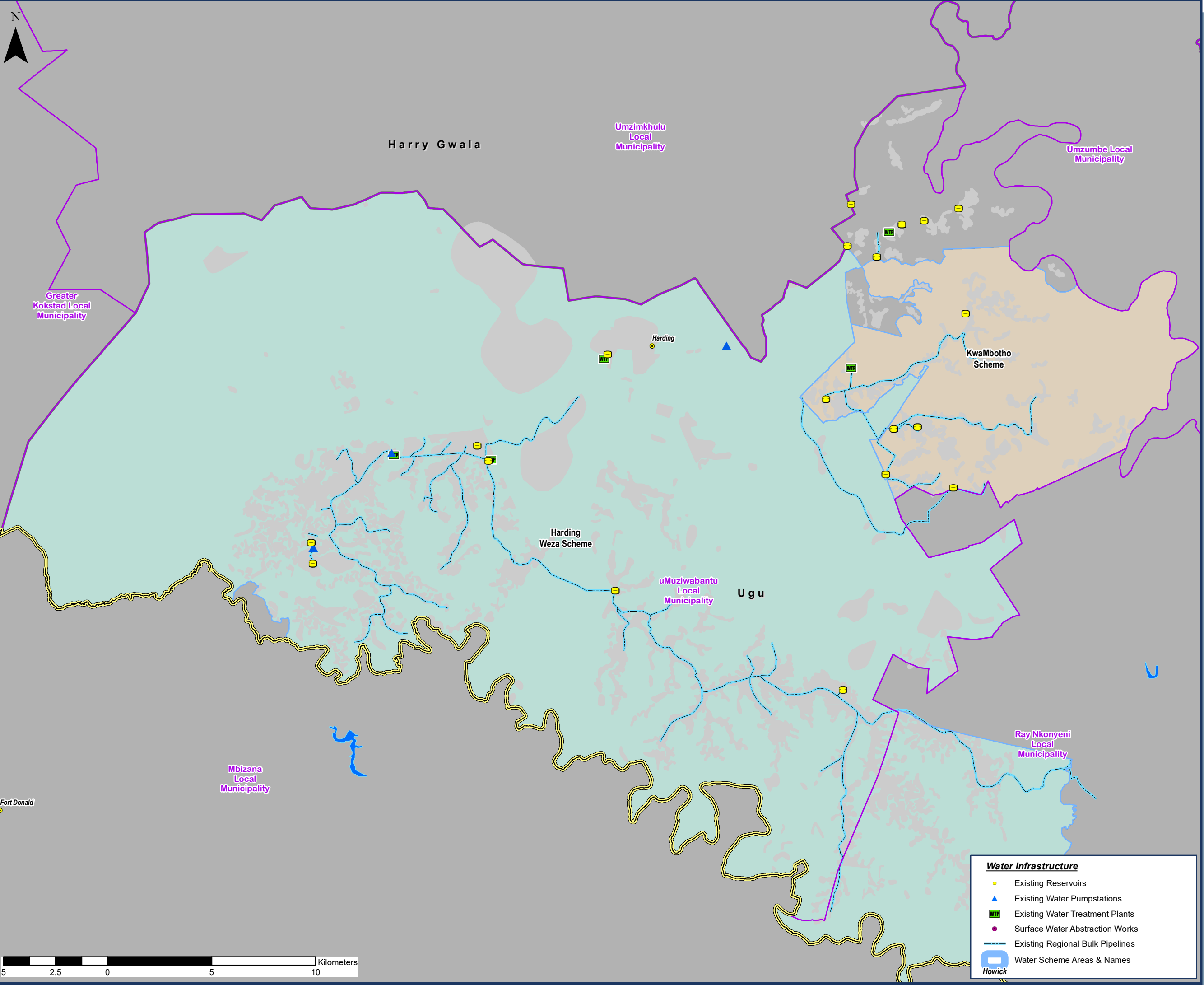

MAP TITLE: Existing Scheme Areas & Infrastructure Components - uMuziwabantu UGU District Municipality

DATE COMPLETED: January 2021

MAP NO.: DC 21 Figure 5-7



Water Infrastructure

-  Existing Reservoirs
-  Existing Water Pumpstations
-  Existing Water Treatment Plants
-  Surface Water Abstraction Works
-  Existing Regional Bulk Pipelines
-  Water Scheme Areas & Names





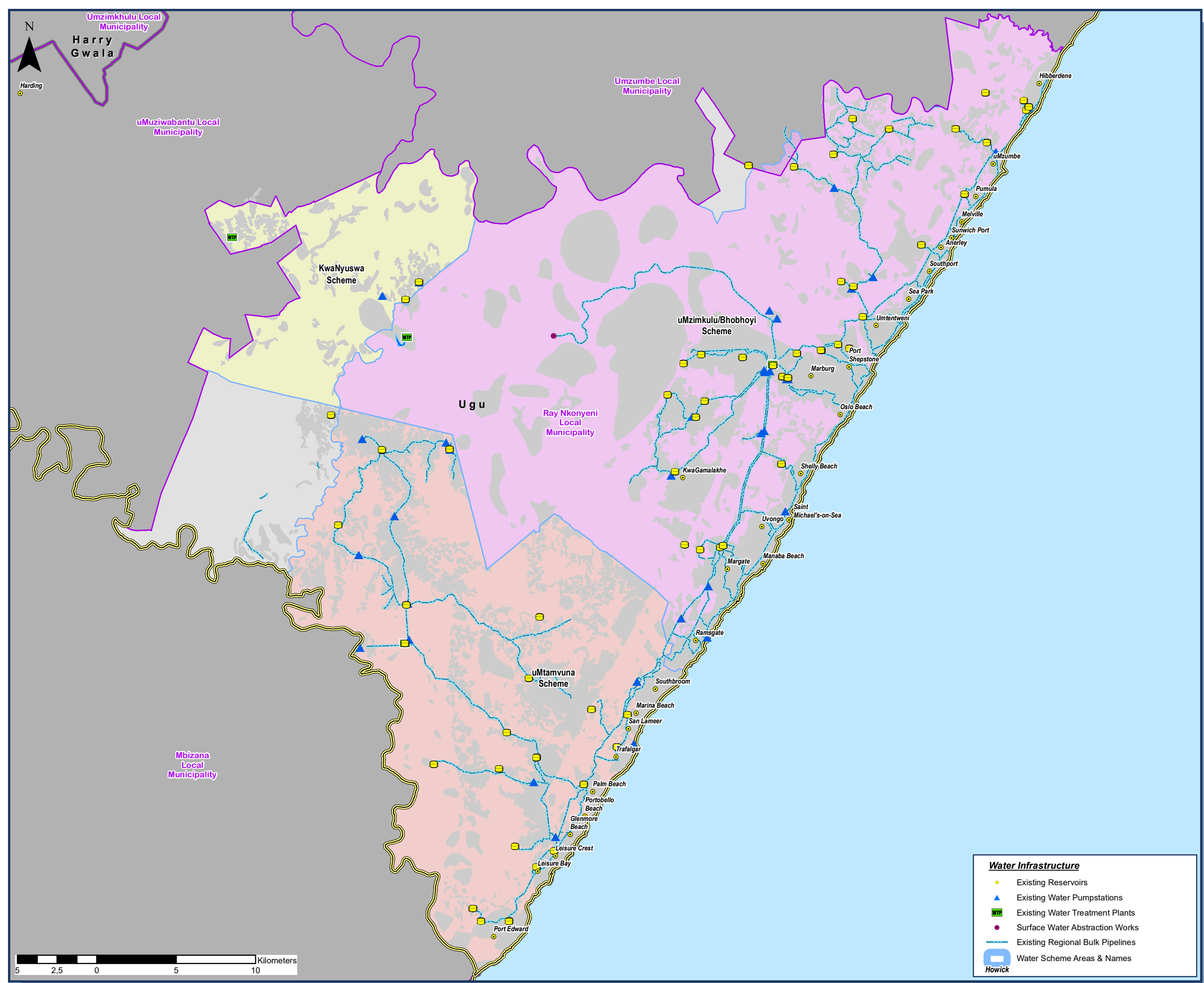

Legend

- Provincial Boundaries
- District Municipality Boundaries
- Local Municipality Boundaries
- National Roads
- Main Roads
- Dams & Dam Names
- Rivers
- Settlements
- Major Towns

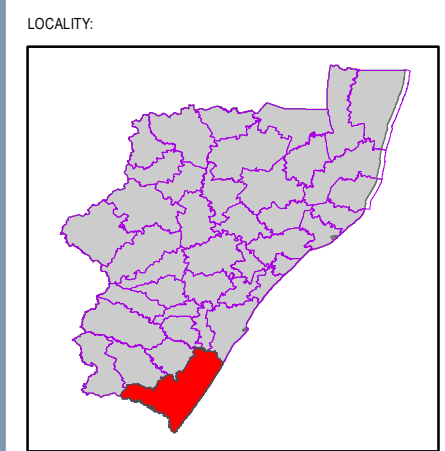

CLIENT:

MUNICIPALITY:

CONSULTANTS

Project No.: 27814

Mariswe
PO Box 25549, Monument Park
Pretoria, 0105

Tel: +27 (0) 12 424 9700
Fax: +27 (0) 12 460 4071
Email: pretoria@uwp.co.za

PROJECT TITLE

UGU DM: Universal Access Plan Phase III - Progressive Development of a Regional Concept Secondary Bulk Water Master Plan

MAP TITLE: Existing Scheme Areas & Infrastructure Components - Ray Nkonyeni UGU District Municipality

DATE COMPLETED: January 2021

MAP NO.: DC 21 Figure 5-8

Water Infrastructure

- Existing Reservoirs
- Existing Water Pumpstations
- Existing Water Treatment Plants
- Surface Water Abstraction Works
- Existing Regional Bulk Pipelines
- Water Scheme Areas & Names

Howick

6. EXISTING SANITATION BULK INFRASTRUCTURE

6.1 SANITATION SERVICE LEVEL

The National Water and Sanitation Master Plan (NW&SMP), prepared in 2018 for South Africa, puts an emphasis on the reliability of water services (water and sanitation). The NW&SMP reported that “In the 27 priority district municipalities the water reliability is only 42%, with the worst 10 WSA’s below 30% reliability” and that “Approximately 56% of the over 1 150 WWTP and approximately 44% of the 962 WTPs are in poor or critical condition and in need of urgent rehabilitation.”

Reliability of services are affected by aging infrastructure, operation and maintenance, reliability of electricity supply, stormwater ingress into sewer systems, vandalism and theft, or extreme weather events. All these then affect sanitation security to consumers and may have negative impacts on the environment.

The DWS Reference Framework database yields that majority of households within Ugu DM use a pit latrine/toilet with a ventilation pipe (approximately 36%).

Table 6-1 below presents the distribution of households by type of toilet facility as per the DWS Reference Framework database as at 2019.

Table 6-1: Distribution of households by type of toilet facility, DWS RF 2019

LM Name	Flush toilet connected to a public sewerage system	Flush toilet connected to a septic tank or conservancy tank	Chemical toilet	Pit latrine/toilet with ventilation pipe	Pit latrine/toilet without ventilation pipe	Ecological toilet (e.g. urine diversion; enviroloo; etc.)	Bucket toilet (collected by municipality) – Bucket toilet (emptied by household)	Other	None	Total
Umdoni	8 312	1 636	5 615	6 940	4 602	10	3 242	3 305	1 771	35 433
Ray Nkonyeni	25 965	3 774	2 328	31 212	18 564	1 825	762	1 193	4 787	90 409
Umzumbe	351	428	4 309	13 643	3 868	1 045	1 321	2 478	689	28 132
Umuziwabantu	1 728	206	2 338	11 406	1 603	972	436	2 165	318	21 172
Total	36 356	6 044	14 590	63 201	28 637	3 853	5 760	9 140	7 565	175 146

Source: DWS Reference Framework, April 2019

The sanitation service provision in the Ugu DM area of jurisdiction is broken down into urban and rural sanitation. With regards to the urban sanitation the service delivery standard is mostly waterborne sewer and for rural sanitation the pit toilets with ventilation (VIP’s).

The current sanitation backlog is approximately 34% as illustrated in the Ugu DM WSDP 2018/2019 and in **Table 6-2** below. However, settlements are continuously expanding, and household growth will maintain an increase in the future.

The Ugu DM WSDP 2018/2019 reports that the current sanitation backlog for the District is as follows:

Table 6-2: Sanitation Backlogs within Ugu District Municipality

Direct Backlogs	Totals
Direct settlement backlog sanitation households. Total household of settlement with a sanitation need (irrelevant the type of need)	18 137
Direct settlement backlog sanitation population. Total population of settlement with a sanitation need (irrelevant the type of need)	81 661

Source: Ugu DM WSDP, 2018-2019

6.2 EXISTING SANITATION BULK INFRASTRUCTURE⁵

The urban areas within Ugu are located predominantly within a narrow coastal strip comprising of a combination of permanent residents and local tourists who descend on the area during holiday periods.

A Sanitation Service Master Plan (SSMP), completed in 2005 for Ugu, suggests that the water demand (and hence wastewater flows) in the peak December/January period is typically 33% higher than the annual average values.

Although largely “residential”, most urban areas include some “commercial” activity and there are also some “light and/or service industrial” nodes particularly in Port Shepstone (Marburg) and Park Rynie to a lesser extent. The urban sanitation comprises a combination of waterborne sewerage linked to Wastewater Treatment Plant (WWTP) as well as a system of septic tanks and conservancy tanks in the less densely populated areas.

Most of the treatment facilities are owned and managed by Ugu although there are also a number of privately owned and managed, small sewage treatment plants – mostly “package” plants. Except for Gamalakhe, the sewerage coverage of formal, urban areas which have a Municipal water connection is approximately 30%.

Being a coastal strip, the topography generally falls towards the coast and is segmented by many water courses (streams/rivers) resulting in numerous hills and valleys as well as very flat areas along the coast. Thus, there are numerous pump stations in the reticulated areas whilst the WWTP’s are generally located inland of the coastal strip such that many of the pump stations deal with pumping heads which exceed those readily achievable with open impeller pumps operating at low speeds.

⁵ Sourced from Ugu DM IDP, 2019

The SSMP notes further that “the geology of the coastal strip may be described in general terms as having rock outcrops all along the coast overlain by one to two metres of sand and with some of these areas being characterised by a high, perched water table” – clearly not ideal for the use of septic tanks with sub-soil percolation drains and as a result there are numerous conservancy tanks within the urban strip.

With regards to rural sanitation, there is no reliable data spatially or otherwise pertaining to either the location or age of Ventilated Improved Pit Latrines (VIP’s) constructed within Ugu. This poses a major challenge as there is no reliable data with which to plan for de-sludging/re-location of VIP’s when full and further prevents the accurate determination of the backlog.

Planning is required in the urban areas to confirm the suitability of the bulk infrastructure, especially with regards to increased pressures on the infrastructure due to an increasing urbanisation trend that has been occurring and also to allow for future growth in population.

According to the DWS Reference Framework, the following twenty (20) sanitation schemes are currently operating within Ugu DM:

Murchison Hospital	Harding
Munster	Kwabonwa
Shelley Beach	Margate
Palm Beach	Melville
Pennington	Mbango
Ramsgate	Skogheim-Bhobhoyi
Scottburgh	Southbroom
Red Desert	Umzinto
Eden Wilds	Uvongo
Gamalakhe	Hibberdene

The Ugu DM has seventeen (17) wastewater treatment plants of which sixteen (16) are operational. The WWTP’s are listed in **Table 6-3**.

Table 6-3: List of Wastewater Treatment Plants

WWTP	Description	Owner	Class	Capacity Sufficient	ADWF Capacity (Mℓ/day)	People Served	Operational	Critical Refurbishment	Cost Estimate
Kwabonwa	Oxidation Ponds	Ugu	D	Y	0.6	63	Y	Unknown	R 293 000
Gamalakhe	Bio-filter	Ugu	C	Y	3.0	2500	Y	Unknown	R 1 160 000
Ramsgate	Activated Sludge	Ugu	C	N	1.2	1125	Y	Unknown	R 817 000
Uvongo	Activated Sludge	Ugu	B	Y	2.4	1875	Y	Unknown	R 860 000
Palm Beach	Activated Sludge	Ugu	C	Y	0.7	750	Y	Unknown	R 714 000
Umzinto	Activated Sludge	Ugu	C	Y	2.5	2000	Y	Unknown	R 984 000
Shelley Beach	Activated Sludge	Ugu	C	N	0.75	875	Y	Unknown	R 589 000
Scottburgh	Activated Sludge	Ugu	B	Y	2.3	2250	Y	Unknown	R 1 995 000
Margate	Activated Sludge	Ugu	B	Y	0.6	6250	Y	Unknown	R 590 000
Murchiston Hospital	Activated Sludge	Ugu		Y	0.2	2500	Y	Unknown	R 619 000
Eden Wilds	Oxidation Ponds	Ugu	D	Y	0.2	188	Y	Unknown	R 625 000
Southbroom	Activated Sludge	Ugu	D	Y	0.2	63	Y	Unknown	R 209 000
Harding	Activated Sludge	Ugu	C	Y	1.6	563	Y	Unknown	R 700 000
Hibberdene	Oxidation Ponds	Ugu	C	Y	0.28		N	Decommissioned	-
Mbango	Activated Sludge	Ugu	B	N	12.0	11250	Y	Unknown	R 2 114 000
Melville	Activated Sludge	Ugu	C	Y	0.28	344	Y	Unknown	R 307 000
Munster	Oxidation Ponds	Ugu	D	Y	0.25	225	Y	Unknown	R 762 000

Source: Umgeni Water, 2020

The sanitation reliability profile and existing infrastructure are presented in **Figure 6-1** and **Figure 6-2** overleaf.

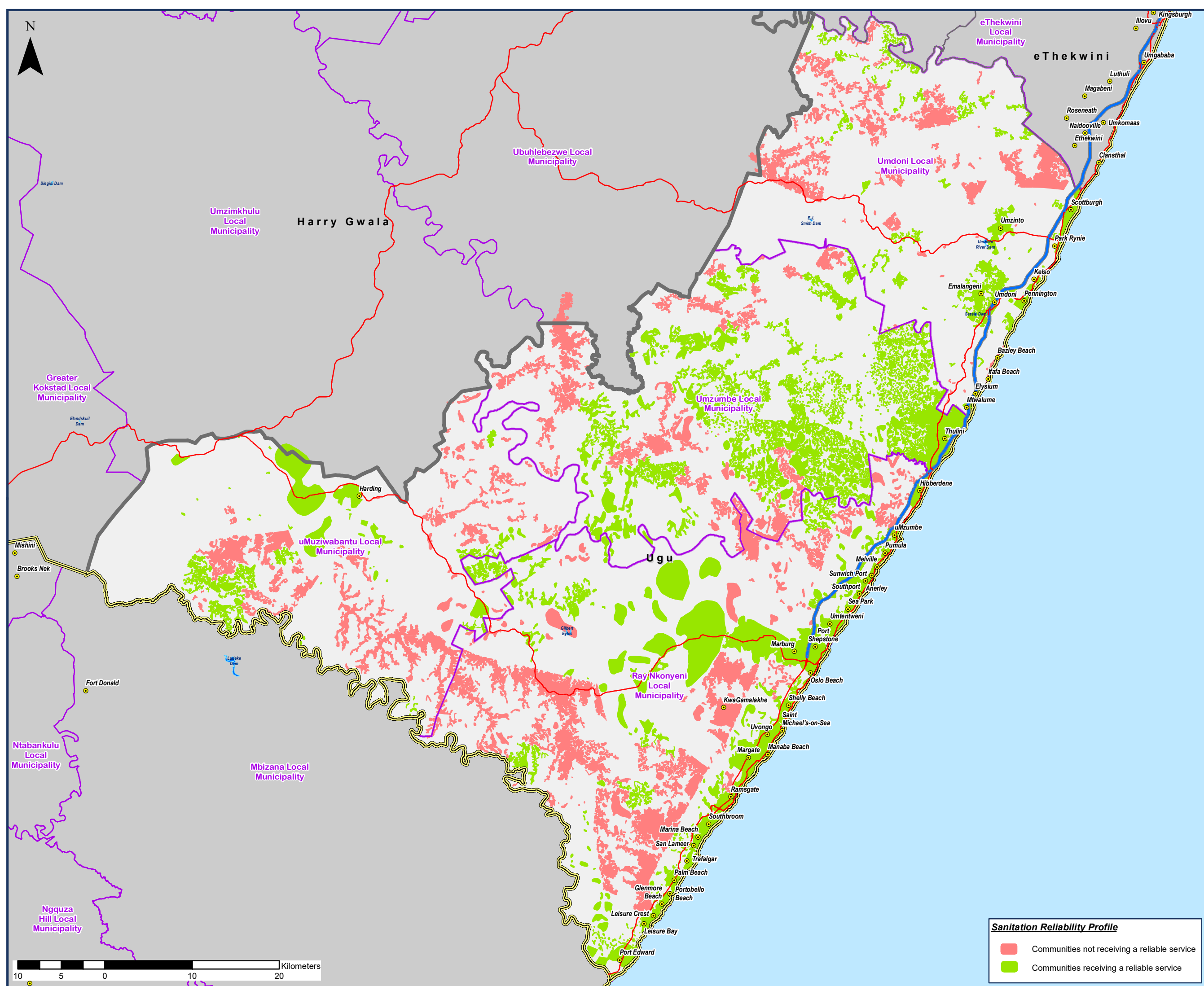

Legend

- Provincial Boundaries
- District Municipality Boundaries
- Local Municipality Boundaries
- National Roads
- Main Roads
- Dams & Dam Names
- Rivers
- Settlements
- Major Towns

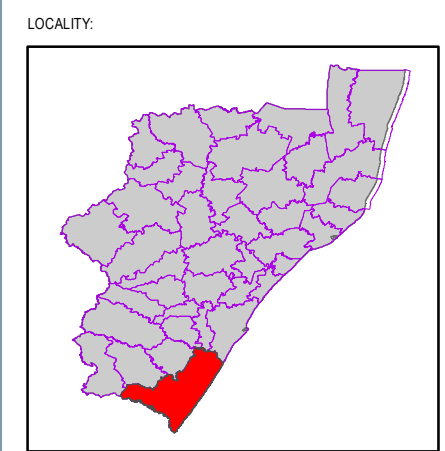

CLIENT:

MUNICIPALITY:

UGU DISTRICT MUNICIPALITY

CONSULTANTS

Project No.: 27814

Mariswe
PO Box 25549, Monument Park
Pretoria, 0105

Tel: +27 (0) 12 424 9700
Fax: +27 (0) 12 460 4071
Email: pretoria@uwp.co.za

PROJECT TITLE

UGU DM: Universal Access Plan Phase III - Progressive Development of a Regional Concept Secondary Bulk Water Master Plan

MAP TITLE:

Sanitation Reliability Profile
UGU District Municipality

DATE COMPLETED:

January 2021

MAP NO.:

DC 21 Figure 6-1

Sanitation Reliability Profile

- Communities not receiving a reliable service
- Communities receiving a reliable service

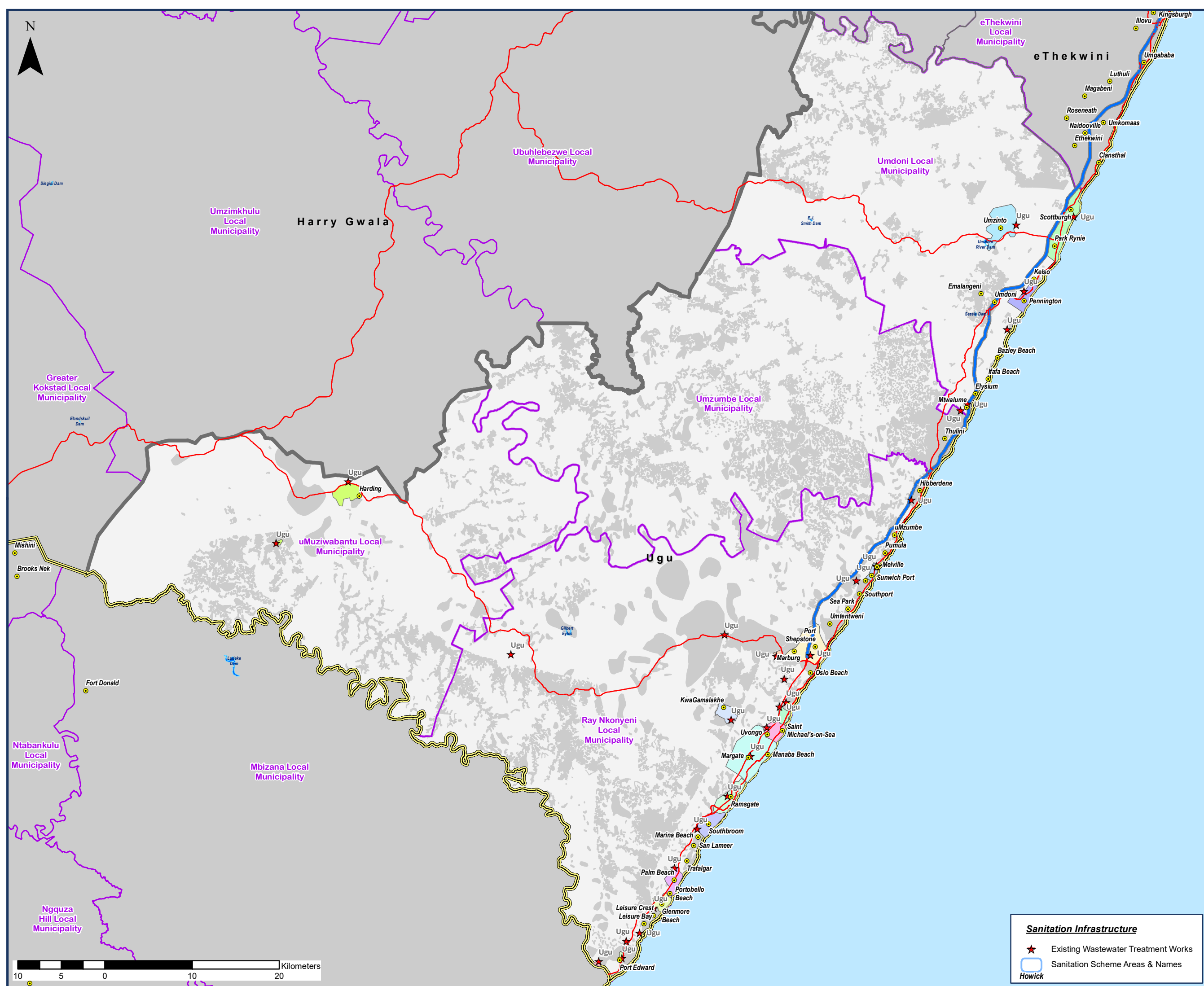

Legend

- Provincial Boundaries
- District Municipality Boundaries
- Local Municipality Boundaries
- National Roads
- Main Roads
- Dams & Dam Names
- Rivers
- Settlements
- Major Towns

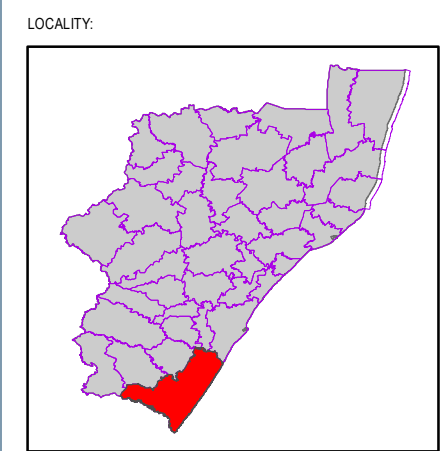

CLIENT:

MUNICIPALITY:

UGU DISTRICT MUNICIPALITY

CONSULTANTS

Project No.: 27814

Mariswe
PO Box 25549, Monument Park
Pretoria, 0105

Tel: +27 (0) 12 424 9700
Fax: +27 (0) 12 460 4071
Email: pretoria@uwp.co.za

PROJECT TITLE

UGU DM: Universal Access Plan Phase III - Progressive Development of a Regional Concept Secondary Bulk Water Master Plan

MAP TITLE:

Existing Sanitation Infrastructure
UGU District Municipality

DATE COMPLETED: January 2021

MAP NO.: DC 21 Figure 6-2

Sanitation Infrastructure

- Existing Wastewater Treatment Works
- Sanitation Scheme Areas & Names

Howick



7. BULK WATER SUPPLY PROJECTS CURRENTLY IN PLANNING

The existing funding grants for the municipal capital projects and operating subsidies for water services are mainly funded by the Municipal Infrastructure Grant (MIG) followed by the Regional Bulk Infrastructure Grant (RBIG) and the Water Services infrastructure Grant (WSIG). The main objective of MIG is to assist WSAs by providing grant funding in removing the backlog concerning basic municipal services to poor households. RBIG focusses on the infrastructure required to connect or augment the water resource on a macro⁶ or sub regional ⁷ scale (over vast distances⁸), with internal bulk and reticulation systems or any bulk supply infrastructure that may have a significant impact on water resources in terms of quantity and quality. The bulk infrastructure that would have a “significant impact on water resources” includes:

- ✓ Any bulk scheme that is designed for maximum demand of 5Mℓ/day or more;
- ✓ Any wastewater treatment plant that discharges into a freshwater resource system; and
- ✓ Any water treatment plant that is designed for a maximum demand of more than 2Mℓ/day.

For the purpose of this study, the existing regional bulk projects were considered and evaluated to identify potential gaps within the existing project footprints to the extent that a total “wall-to-wall” bulk water services needs perspective is visualised and realised. This must be done in the context to improve access to basic services but at the same time support economic growth and development and ensure sustainable services.

This Chapter provides a brief overview of existing and planned bulk water infrastructure projects sourced from the Ugu DM 2018/2019 WSDP.

⁶ “Macro” is defined as infrastructure serving extensive areas across multi-municipal boundaries

⁷ “Sub-regional” is defined as large regional bulk infrastructure serving numerous communities over a large area normally within a specific district or local municipal area

⁸ Over “vast distances” is considered as any distances greater than 5km

7.1 REGIONAL BULK WATER PROJECTS IN PLANNING

The Ugu DM mainly receives their funding from MIG and WSIG. No regional bulk infrastructure projects within Ugu receive funding from RBIG according to the Division of Revenue Bill Schedule.

The funding streams for infrastructure development over the next three years are tabled in **Table 8-1** below.

Table 8-1: Grant Funding Streams

Grant Funding Programme	2019/2020 (R '000)	2020/2021 (R '000)	2021/2022 (R '000)	Total Funding over Next 3 Financial Years
Municipal Infrastructure Grant (MIG)	R241 038	R255 284	R275 780	R772 102
Water Services Infrastructure Grant (WSIG)	R50 000	R60 000	R62 350	R172 350
Regional Bulk Infrastructure Grant (RBIG)	-	-	-	-
Total: Ugu District Municipality	R291 038	R315 284	R338 130	R944 452

Source: Division of Revenue Bill Schedule (DORA), 2019/2020

The funding allocations per Local Municipality as presented in DORA, is presented in **Table 8-2** below.

Table 8-2: Three-Year Medium-Term Expenditure Framework (MTEF) per Local Municipality in Ugu DM

LM Name	Municipal Infrastructure Grant (MIG)			Water Services Infrastructure Grant (WSIG)		
	2019/2020 (R '000)	2020/2021 (R '000)	2021/2022 (R '000)	2019/2020 (R '000)	2020/2021 (R '000)	2021/2022 (R '000)
Ugu District Municipality	R241 038	R255 284	R275 780	R50 000	R60 000	R62 350

Source: Division of Revenue Bill Schedule (DORA), 2019/2020

Umgeni Water is the Water Services Provider for Ugu District Municipality, the Water Services Authority (WSA). **Table 8-3** outlines the projects planned by Umgeni Water in the Ugu DM municipal area.

Table 8-3: Umgeni Water Projects for Ugu DM (2019)

Project Name	Beneficiaries	Project Status	Project Components
Nungwane Raw Water Pipeline	Upper & Middle South Coast Regions	Construction	Pipelines
South Coast Pipeline 2b – Kelso to Malangeni	Umdoni	Tender	Pipelines
Mhlabatshane Bulk Water Supply Scheme Phase 2	Umzumbe & Ray Nkonyeni	Detailed Design	Weirs, Pumpstations, Pipelines, Balancing Tanks/Reservoirs WTP Upgrade & Hydrocyclones
Lower uMkhomazi Bulk Water Supply Scheme	Upper & Middle South Coast Regions	Detailed Design	Dam, Weirs, Pumpstations, Pipelines, Hydrocyclone, Reservoirs & WTP
South Coast Pipeline Ph 3 - Mhlali to Hibberdene	Umzumbe & Umdoni	Detailed Feasibility	Pumpstations, Pipelines & Reservoirs

Project Name	Beneficiaries	Project Status	Project Components
Raw-Water Augmentation to the Amanzimtoti Supply System from the Lovu River	Upper & Middle South Coast Regions	Tender	Abstraction, Pumpstations & Pipelines

Source: Umgeni Water, 2020

Other notable Department of Water and Sanitation/Ugu projects include the following:

- ✓ The Weza River Raw Water Emergency Scheme;
- ✓ The Ncwabeni OCS Dam;
- ✓ The Mtamvuna WTP and raw water abstraction upgrade; and
- ✓ The Vulamehlo Dam.

8. SYNOPSIS OF EXISTING AND COMMITTED SCHEMES

A gap analysis has been undertaken for the water schemes in the Ugu DM. The purpose of the gap analysis is to check the adequacy of infrastructure to allow the 2050 water demand to be supplied, and where necessary identify upgrades to infrastructure.

The gap analysis has taken into account current planning interventions by the WSA. The interventions required to meet the 2050 water demand inclusive of infrastructure planning and recommended water resource investigations is discussed in Chapter 9 of this study.

The entire Ugu DM has been demarcated into regional water schemes in line with short and long-term plans by the WSA. A gap analysis has been undertaken for the water schemes in the Ugu DM. The gap analysis has taken into account current planning interventions by the WSA. Fifteen (15) regional schemes have been identified and are as follows:

- ✓ UG001 WSIA: uMzinto Water Supply Scheme;
- ✓ UG002 WSIA: uMtwalume Water Supply Scheme;
- ✓ UG003 WSIA: uMzimkhulu/Bhobhoyi Water Supply Scheme;
- ✓ UG004 WSIA: Umtamvuna Water Supply Scheme;
- ✓ UG005 WSIA: Harding/Weza Water Supply Scheme;
- ✓ UG006 WSIA: KwaFodo Water Supply Scheme;
- ✓ UG007 WSIA: KwaLembe Water Supply Scheme;
- ✓ UG008 WSIA: Pungashe/Mhlabatshane Water Supply Scheme;
- ✓ UG009 WSIA: KwaHlongwa Water Supply Scheme;
- ✓ UG010 WSIA: Vulamehlo Farming Scheme;
- ✓ UG011 WSIA: Vulamehlo Water Supply Scheme;
- ✓ UG012 WSIA: Greater Vulamehlo Cross Border Water Supply Scheme;
- ✓ UG013 WSIA: KwaMbotho Water Supply Scheme;
- ✓ UG014 WSIA: KwaNdelu Water Supply Scheme; and
- ✓ UG015 WSIA: KwaNyuswa water Supply Scheme.

8.1 UG001 WSIA: UMZINTO SCHEME

The uMzinto Supply Scheme abstracts water from uMzinto Dam and EJ Smith Dam. The dams have a yield of 5.6 Mℓ/day and 3.3 Mℓ/day respectively. Water from these sources is then conveyed to the uMzinto WTP where it is treated. The capacity of the plant is 13.6 Mℓ/day.

An emergency supply has been installed to pump water from Phambanyoni River to the EJ Smith dam that feeds the Umzinto WTP. The WTP will supply approximately an additional 4 Mℓ/day of water to the Umzinto WTP. (Ugu WSDP, 2015-2020)

The existing infrastructure capacity is compared with the projected 2050 demand. This comparison is provided in **Table 8-1** below.

Table 8-1: uMzinto Scheme Gap Analysis

Criteria	Existing Capacity	Planned Additional	Total	Desired 2050	Additional Requirements
Water Treatment (Mℓ/d)	8.9	21.44	30.34	31.47	1.13
Storage (Mℓ)	38	-	38	49	11
Bulk conveyance - Raw Water (Mℓ/d)	8.9	21.44	30.34	31.47	1.13
Bulk conveyance - Clear Water (Mℓ/d)	8.9	21.44	30.34	31.47	1.13

Based on the capacities of existing and planned infrastructure, there are gaps within the water supply requirements for the projected 2050 demand and the capacities of the existing WTP, the bulk pipelines, secondary and tertiary reservoirs would need to be increased to meet the demand of 2050

There are three (3) MIG water supply projects identified in the uMzinto WSS area:

- ✓ Greater Vulamehlo WSS;
- ✓ KwaCele WSS;
- ✓ Mistake Farm WSS;

Planned and current MIG and RBIG projects that will have an impact on the bulk infrastructure should be considered when planning the bulk infrastructure requirements.

8.2 UG002 WSIA: MTWALUME WATER SUPPLY SCHEME

The Mtwalume WSS draws raw water from the Mtwalume River abstraction point at a rate of 1.3 Mm³/a (4.4 Mℓ/day). The registered use of the source according to WARMS is 3.1 Mm³/a or 8.5Mℓ/day.

The raw water is conveyed to the Mtwalume WTP where it is treated and distributed. The conventional Mtwalume WTP has a current capacity of 7.5 Mℓ/day and it was recently augmented with a 2 Mℓ/day package plant. (Bigen Africa, 2016)

The existing infrastructure capacity is compared with the projected 2050 demand. This comparison is provided in **Table 8-2** below.

Table 8-2: Mtwalume Scheme Gap Analysis

Criteria	Existing Capacity	Planned Additional	Total	Desired 2050	Additional Requirements
Water Treatment (Mℓ/d)	8.5	9.38	17.88	24.79	6.91
Storage (Mℓ)	11.25	-	11.25	61.975	50.725
Bulk conveyance – Raw Water (Mℓ/d)	8.5	9.38	17.88	24.79	6.91
Bulk conveyance – Clear Water (Mℓ/d)	8.5	9.38	17.88	24.79	6.91

Based on the capacities of existing and planned infrastructure, there are gaps within the water supply requirements for the projected 2050 demand and the capacity of the existing water resource, the WTP, the bulk pipelines, the secondary and tertiary reservoirs would need to be increased to meet the demand of 2050.

8.3 UG003 WSIA: MZIKHULU/BHOBOHOI SCHEME

The uMzimkhulu River is the water resource for the uMzimkhulu/Bhobhoi WSS. The capacity of the run-of-river abstraction point at St Helen's Rock is 50.1 Mℓ/day with a current WARMS allocation of 31.51 Mℓ/day. An off channel storage is used to source water from where water is pumped from the St Helen's Rock pump station to Blunt. The pumping is carried out in the off-season.

The raw water is conveyed to the uMzimkhulu WTP for treatment. The WTP has been recently upgraded to a capacity of 83 Mℓ/day. Plans are in place to increase the WTP capacity even further to 108 Mℓ/day.

A feasibility study was undertaken for the proposed Ncwabeni Off Channel Storage Dam by BKS (Pty) Ltd. The OCS dam with an associated diversion weir and abstraction works on the Mzimkhulu River was investigated. A yield of 83 Mℓ/day was determined using a wall height of 47m, at full supply level. The South Coast Pipeline Phase 3 will supply the Woodgrange Reservoir with 10 Mℓ/day that will feed the Umtentweni, Chabane and Hibberdene areas.

The existing infrastructure capacity is compared with the projected 2050 demand. This comparison is provided in **Table 8-3**.

Table 8-3: uMzimkhulu/Bhobhoyi Scheme Gap Analysis

Criteria	Existing Capacity	Planned Additional	Total	Desired 2050	Additional Requirements
Water Treatment (Mℓ/d)	83	10	93	104.64	11.64
Storage (Mℓ)	90.89	-	90.89	110	19.11
Bulk conveyance - Raw Water (Mℓ/d)	83	10	93	104.64	11.64
Bulk conveyance - Clear Water (Mℓ/d)	83	10	93	104.64	11.64

Based on the capacities of existing and planned infrastructure, there are gaps within the water supply requirements for the projected 2050 demand and the secondary and tertiary reservoirs would need to be increased to meet the demand of 2050.

8.4 UG004 WSIA: UMTAMVUNA SCHEME

The Umtamvuna Supply Scheme abstracts and treats water from the Umtamvuna River for the areas that include the inland parts of Ray Nkonyeni LM, kwaXolo, kwaShoba/Mdlazi, and kwaShobeni and coastal strip areas from Ramsgate to Port Edward.

The water source has a yield of 33 Mℓ/day and a registered use of 9.5 Mℓ/day. Water from the abstraction point is treated at the Mtamvuna WTP. The plant capacity was recently upgraded from 20 Mℓ/day to 30 Mℓ/day. Advanced plans are in place to further increase the capacity to 50 Mℓ/day. (UW IMP, 2020)

The existing infrastructure capacity is compared with the projected 2050 demand. This comparison is provided in Table 8-4.

Table 8-4: Umtamvuna Scheme Gap Analysis

Criteria	Existing Capacity	Planned Additional	Total	Desired 2050	Additional Requirements
*Water Treatment (Mℓ/d)	33	17	50	48	N/A
Storage (Mℓ)	34.25	-	34.25	43.15	8.9
Bulk conveyance - Raw Water (Mℓ/d)	33	17	50	44	N/A
Bulk conveyance - Clear Water (Mℓ/d)	33	17	50	44	N/A

Based on the capacities of existing and planned infrastructure, there are gaps within the water supply requirements for the projected 2050 demand and the secondary and tertiary reservoirs would need to be increased to meet the demand of 2050.

8.5 UG005 WSIA: HARDING/WEZA SCHEME

The Harding/Weza Water Supply Scheme sources water from the Weza River and the Amanzimnyama Dam.

The Weza River and Amanzimnyama Dam sources have a combined yield of 5.2 Mℓ/day. Raw water from the sources are treated at the Weza WTP and the Harding WTP. The WTP's have capacities of 3.6 Mℓ/day and 1.2 Mℓ/day respectively. Ugu DM also have a borehole supply of 0.6 Mℓ/day being pumped into the Amanzimnyama Dam.

The scheme supplies the rural areas of KwaMachi, kwaJali, kwaMthimude and the town of Harding. Progressively, the scheme has also been extended to incorporate the areas of kwaMbotho and kwaFodo and the current treatment requirements thereof incorporated into the Harding/Weza WTP.

The existing infrastructure capacity is compared with the projected 2050 demand. This comparison is provided in **Table 8-5**.

Table 8-5:Harding/Weza Scheme Gap Analysis

Criteria	Existing Capacity	Planned Additional	Total	Desired 2050	Additional Requirements
Water Treatment (Mℓ/d)	4.8	11.8	16.6	36.97	20.37
Storage (Mℓ)	18.8	-	18.8	15.5	N/A
Bulk conveyance - Raw Water (Mℓ/d)	4.8	-	4.8	36.97	32.17
Bulk conveyance - Clear Water (Mℓ/d)	4.8	-	4.8	36.97	32.17

Based on the capacities of existing and planned infrastructure, there are gaps within the water supply requirements for the projected 2050 demand and the capacity of existing WTP, the bulk pipelines, secondary and tertiary reservoirs would need to be increased to meet the demand of 2050.

8.6 UG006 WSIA: KWAFODO SCHEME

The KwaFodo scheme sources water from the Cekeza River weir. The yield of the source and its authorised abstraction are unknown at this stage. The yield is, however, reportedly inadequate for the required current use. The raw water sourced is treated at the kwaFodo WTP. The plant has a capacity of 0.3 Mℓ/day. (Bigen Africa, 2016)

The scheme is also interconnected to the Harding/Weza scheme from where it is supplied with treated water from the upgraded Harding WTP.

The existing infrastructure capacity is compared with the projected 2050 demand. This comparison is provided in **Table 8-6**.

Table 8-6: kwaFodo Scheme Gap Analysis

Criteria	Existing Capacity	Planned Additional	Total	Desired 2050	Additional Requirements
Water Treatment (Mℓ/d)	-	-	-	2.7	2.7
Storage (Mℓ)	-	-	-	6.4	6.4
Bulk conveyance - Raw Water (Mℓ/d)	-	-	-	2.7	2.7
Bulk conveyance - Clear Water (Mℓ/d)	-	-	-	2.7	2.7

Based on the capacities of existing and planned infrastructure, there are gaps within the water supply requirements for the projected 2050 demand and the WTP, bulk pipelines, secondary and tertiary reservoirs would need to be increased to meet the demand of 2050.

8.7 UG007 WSIA: KwaLembe Scheme

The KwaLembe Scheme abstracts water from the Mkhomazi River from a run-off-river abstraction point. The yield of the Mkhomazi River at abstraction is estimated at 16.85 Mm³/a (46 Mℓ/day). The raw water is treated at the Lembe WTP. The plant has a capacity of 1.4Mℓ/day. (Bigen Africa, 2016)

UAP Phase II showed a planned MIG funded upgrade in the form of a new 6 Mℓ/day WTP, construct a weir across the Mkomazi River and upgrade approximately 23km of existing pipelines and distribution infrastructure.

The existing and planned infrastructure capacity is compared with the projected 2050 demand. This comparison is provided in **Table 8-7**.

Table 8-7:KwaLembe Scheme Gap Analysis

Criteria	Existing Capacity	Planned Additional	Total	Desired 2050	Additional Requirements
Water Treatment (Mℓ/d)	1.4	4.6	6	4.92	N/A
Storage (Mℓ)	-	-	-	12	12
Bulk conveyance - Raw Water (Mℓ/d)	1.4	4.6	6	4.92	N/A
Bulk conveyance - Clear Water (Mℓ/d)	1.4	4.6	6	4.92	N/A

Based on the capacities of existing and planned infrastructure, there are gaps within the water supply requirements for the projected 2050 demand and the secondary and tertiary reservoirs would need to be increased to meet the demand of 2050.

8.8 UG008 WSIA: PUNGASHE/MHLABATSHANE SCHEME

The Pungashe/Mhlabatshane Supply Scheme abstracts and treats water from the Mhlabatshane Dam, the dam has a yield of 1.6 Mm³/a or 4.4 Mℓ/day. The registered use of this source is not known.

The raw water is conveyed to the Mhlabatshane WTP for treatment. The plant has a capacity of 4 Mℓ/day.

The existing infrastructure capacity is compared with the projected 2050 demand. This comparison is provided in **Table 8-8**.

Table 8-8: Scheme Gap Analysis

Criteria	Existing Capacity	Planned Additional	Total	Desired 2050	Additional Requirements
Water Treatment (Mℓ/d)	4.4	12	16.4	18.32	1.92
Storage (Mℓ)	4	8.4	12.4	18.32	5.92
Bulk conveyance - Raw Water (Mℓ/d)	4.4	12	16.4	18.32	1.92
Bulk conveyance - Clear Water (Mℓ/d)	4.4	12	16.4	18.32	1.92

Based on the capacities of existing and planned infrastructure, there are gaps within the water supply requirements for the projected 2050 demand and capacities of the WTP, the bulk pipelines, secondary and tertiary reservoirs would need to be increased to meet the demand of 2050.

8.9 UG009 WSIA: KWAHLONGWA SCHEME

The kwaHlongwa Scheme abstracts its water from Malukaka River which is a tributary of the Mzambe River. The yield of the source is unknown. The raw water is conveyed to the 1.3 Mℓ/day kwaHlongwa WTP for treatment. The abstraction point reportedly has inadequate yield for the required demand.

The standalone water source is planned to be decommissioned and connected to the KwaNdelu Scheme. (Bigen Africa, 2016)

The existing infrastructure capacity is compared with the projected 2050 demand. This comparison is provided in **Table 8-9**.

Table 8-9: kwaHlongwa Scheme Gap Analysis

Criteria	Existing Capacity	Planned Additional	Total	Desired 2050	Additional Requirements
Water Treatment (Mℓ/d)	-	-	-	2.01	2.01
Storage (Mℓ)	-	-	-	4	4
Bulk conveyance - Raw Water (Mℓ/d)	-	-	-	2.01	2.01
Bulk conveyance - Clear Water (Mℓ/d)	-	-	-	2.01	2.01

Based on the capacities of existing and planned infrastructure, there are gaps within the water supply requirements for the projected 2050 demand and capacities of the WTP, the bulk pipelines, secondary and tertiary reservoirs would need to be increased to meet the demand of 2050.

8.10 UG010 WSIA: VULAMEHLO FARMING SCHEME

The scheme is a collection of standalone borehole supplied areas. There is no information about the capacities and operation of these boreholes.

The existing infrastructure capacity is compared with the projected 2050 demand. This comparison is provided in **Table 8-10**.

Table 8-10: Vulamehlo Farming Scheme Gap Analysis

Criteria	Existing Capacity	Planned Additional	Total	Desired 2050	Additional Requirements
Water Treatment (Mℓ/d)	-	-	-	6.26	6.26
Storage (Mℓ)	-	-	-	2.2	2.2
Bulk conveyance - Raw Water (Mℓ/d)	-	-	-	6.26	6.26
Bulk conveyance - Clear Water (Mℓ/d)	-	-	-	6.26	6.26

Based on the capacities of existing and planned infrastructure, there are gaps within the water supply requirements for the projected 2050 demand and the capacities of the WTP, the bulk pipelines, secondary and tertiary reservoirs would need to be increased to meet the demand of 2050.

8.11 UG011 WSIA: VULAMEHLO SCHEME

The Vulamehlo Scheme receives treated water from the Ndelu WTP. The raw water is abstracted from the Mzombe River at the Ndelu abstraction point. The yield of the river at the abstraction point is 4.4 Mℓ/day. The registered use of this source is not known. The Ndelu WTP has a capacity of 1.4Mℓ/day that also supplies the Ndelu WSS.

There are future plans to supply portions of the Greater Vulamehlo Scheme and the kwaHlongwa Scheme from the Ndelu Scheme. Water from the Ndelu WTP is pumped to Gangazolo reservoir from where it gravitates to Vulamehlo Scheme command reservoir.

The existing infrastructure capacity is compared with the projected 2050 demand. This comparison is provided in **Table 8-11**.

Table 8-11: Vulamehlo Scheme Gap Analysis

Criteria	Existing Capacity	Planned Additional	Total	Desired 2050	Additional Requirements
Water Treatment (Mℓ/d)	1.4 (Ndelu WTP)	-	1.4	8.79	7.39
Storage (Mℓ)	-	-	0	21.98	21.98
Bulk conveyance - Raw Water (Mℓ/d)	-	-	0	8.79	8.79
Bulk conveyance - Clear Water (Mℓ/d)	-	-	0	8.79	8.79

Based on the capacities of existing and planned infrastructure, there are gaps within the water supply requirements for the projected 2050 demand and the capacities of the WTP, the bulk pipelines, secondary and tertiary reservoirs would need to be increased to meet the demand of 2050.

8.12 UG012 WSIA: GREATER VULAMEHLO CROSS BORDER SCHEME

The Greater Vulamehlo Cross Border Scheme abstracts water from the Upper Mtwalume River. The abstraction point has a capacity of 1.6 Mℓ/day. The registered use of this source is not known. The raw water is treated at the 4.5Mℓ/day Vulamehlo WTP. The scheme benefits areas in both the Ugu and Harry Gwala DM's.

The existing infrastructure capacity is compared with the projected 2050 demand. This comparison is provided in **Table 8-12** overleaf.

Table 8-12: Greater Vulamehlo Cross Border Scheme Gap Analysis

Criteria	Existing Capacity	Planned Additional	Total	Desired 2050	Additional Requirements
Water Treatment (Mℓ/d)	4.5	5.7	10.2	15.62	5.42
Storage (Mℓ)	10.25	-	10.25	26.6	16.35
Bulk conveyance - Raw Water (Mℓ/d)	4.5	5.7	10.2	15.62	5.42
Bulk conveyance - Clear Water (Mℓ/d)	4.5	5.7	10.2	15.62	5.42

Based on the capacities of existing and planned infrastructure, there are gaps within the water supply requirements for the projected 2050 demand and the capacities of the WTP, the bulk pipelines, secondary and tertiary reservoirs would need to be increased to meet the demand of 2050.

8.13 UG013 WSIA: KWAMBOTHO SCHEME

The kwaMbotho Scheme abstracts water from the Ncekethe River for treatment at the kwaMbotho WTP. The current and registered abstraction capacity of the abstraction point is not known. The WTP has a capacity of 0.25 Mℓ/day. It is planned to connect the scheme to Harding/Weza Scheme and decommission the standalone water source and WTP. There is an existing emergency connection to the Harding/Weza Scheme. (Bigen Africa, 2016)

The existing infrastructure capacity is compared with the projected 2050 demand. This comparison is provided in **Table 8-13**.

Table 8-13: KwaMbotho Scheme Gap Analysis

Criteria	Existing Capacity	Planned Additional	Total	Desired 2050	Additional Requirements
Water Treatment (Mℓ/d)	-	-	1.4	5	3.6
Storage (Mℓ)	-	-	-	11.7	11.7
Bulk conveyance - Raw Water (Mℓ/d)	-	-	1.4	5	3.6
Bulk conveyance - Clear Water (Mℓ/d)	-	-	1.4	5	3.6

Based on the capacities of existing and planned infrastructure, there are gaps within the water supply requirements for the projected 2050 demand and the capacities of the WTP, the bulk pipelines, secondary and tertiary reservoirs would need to be increased to meet the demand of 2050.

8.14 UG014 WSIA: KWANYUSWA SCHEME

The scheme abstracts its water from the local river and from the Gilbert Eyles Dam. The yield of both sources are unknown. The raw water is conveyed to the Nyuswa WTP 1 and Nyuswa WTP 2 for treatment. The capacity of WTP 2 is 0.2 Mℓ/day and the capacity of WTP 1 is unknown.

The existing infrastructure capacity is compared with the projected 2050 demand. This comparison is provided in **Table 8-14**.

Table 8-14: KwaNyuswa Scheme Gap Analysis

Criteria	Existing Capacity	Planned Additional	Total	Desired 2050	Additional Requirements
Water Treatment (Mℓ/d)	0.25	-	0.25	3.24	2.99
Storage (Mℓ)	1.4		1.4	8.1	6.7
Bulk conveyance - Raw Water (Mℓ/d)	0.25	-	0.25	3.24	2.99
Bulk conveyance - Clear Water (Mℓ/d)	0.25	-	0.25	3.24	2.99

Based on the capacities of existing and planned infrastructure, there are gaps within the water supply requirements for the projected 2050 demand and the capacities of the WTP, the bulk pipelines, secondary and tertiary reservoirs would need to be increased to meet the demand of 2050.

8.15 UG015 WSIA: KWANDELU SCHEME

The Ndelu Scheme abstracts its water from uMzumbe River. The yield of this river is estimated at 1.6Mm³/a or 4.4Mℓ/day. The registered use of this source is not known. The raw water is conveyed to the 1.4Mℓ/day Ndelu WTP for treatment. The Ndelu Scheme also supplies water to the kwaHlongwa Scheme and a portion of Vulameho Scheme.

The existing infrastructure capacity is compared with the projected 2050 demand. This comparison is provided in **Table 8-15**.

Table 8-15: Ndelu Scheme Gap Analysis

Criteria	Existing Capacity	Planned Additional	Total	Desired 2050	Additional Requirements
Water Treatment (Mℓ/d)	1.4	-	1.4	8.5	7.1
Storage (Mℓ)	-	-	0	10.475	10.475
Bulk conveyance - Raw Water (Mℓ/d)	1.4	-	1.4	8.5	7.1
Bulk conveyance - Clear Water (Mℓ/d)	1.4	-	1.4	8.5	7.1

Based on the capacities of existing and planned infrastructure, there are gaps within the water supply requirements for the projected 2050 demand and capacities of the WTP, the bulk pipelines, secondary and tertiary reservoirs would need to be increased to meet the demand of 2050.

9. PROPOSED BULK WATER SUPPLY INTERVENTIONS

This section details the water supply reconciliation options for bulk water services within the Ugu DM – considering existing use and future supplies and water sources, per scheme area. It must be noted that the Water Supply Intervention Areas (WSIA's) were demarcated based on all the existing planning initiatives that are currently underway within the WSA. However, the demand model that was proposed to be used within this project will be used to determine the proposed bulk infrastructure requirements and would be sized accordingly to meet the demand of 2050.

It is recommended that the predominantly farmland, stand-alone areas not covered by schemes, be supplied by localised schemes (boreholes etc.) due to the sparse population and the proximity of the area in relation to the other regional schemes.

The details of each proposed upgrade and future additional requirements/interventions are provided per WSIA within the sections and paragraphs hereafter and illustrated for the entire WSA within **Figure 9-1**.

The following WSIA's are discussed further in this section:

- ✓ UG001 WSIA: uMzinto Water Supply Scheme;
- ✓ UG002 WSIA: Mtwalume Water Supply Scheme;
- ✓ UG003 WSIA: uMzimkhulu/Bhobhoyi Water Supply Scheme;
- ✓ UG004 WSIA: uMtamvuna Water Supply Scheme;
- ✓ UG005 WSIA: Harding/Weza Water Supply Scheme;
- ✓ UG006 WSIA: KwaFodo Water Supply Scheme;
- ✓ UG007 WSIA: Kwalembe Water Supply Scheme;
- ✓ UG008 WSIA: Pungashe/Mhlabatshane Water Supply Scheme;
- ✓ UG009 WSIA: KwaHlongwa Water Supply Scheme;
- ✓ UG010 WSIA: Vulamehlo Farming Scheme;
- ✓ UG011 WSIA: Vulamehlo Water Supply Scheme;
- ✓ UG012 WSIA: Greater Vulamehlo Cross Border Water Supply Scheme;
- ✓ UG013 WSIA: Mbotho Water Supply Scheme;
- ✓ UG014 WSIA: kwaNdelu Water Supply Scheme; and
- ✓ UG015 WSIA: kwaNyuswa water Supply Scheme.

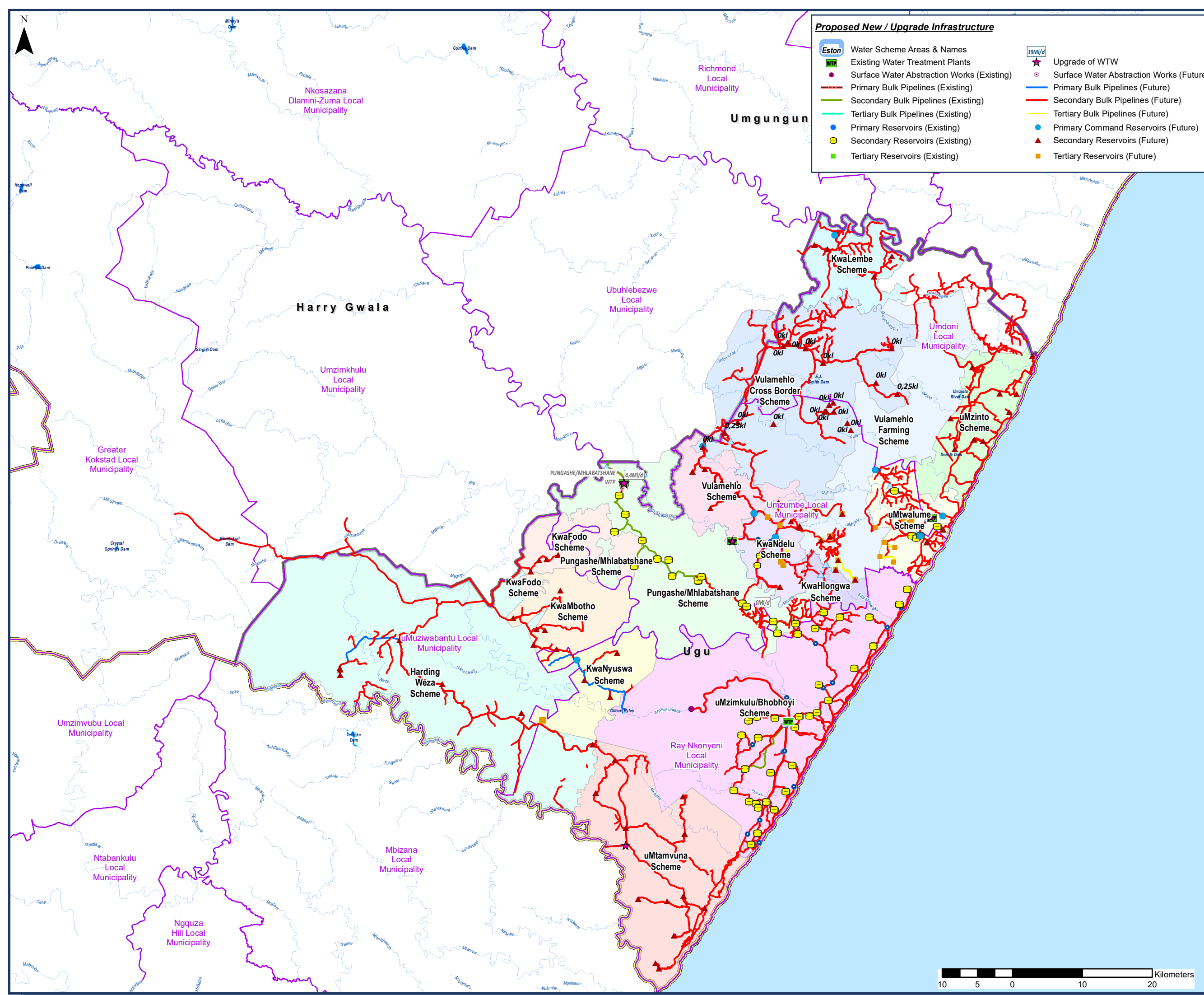

Proposed New / Upgrade Infrastructure

Water Scheme Areas & Names	Upgrade of WTW
Existing Water Treatment Plants	Surface Water Abstraction Works (Future)
Surface Water Abstraction Works (Existing)	Primary Bulk Pipelines (Future)
Primary Bulk Pipelines (Existing)	Secondary Bulk Pipelines (Future)
Secondary Bulk Pipelines (Existing)	Tertiary Bulk Pipelines (Future)
Tertiary Bulk Pipelines (Existing)	Primary Command Reservoirs (Future)
Primary Reservoirs (Existing)	Secondary Reservoirs (Future)
Secondary Reservoirs (Existing)	Tertiary Reservoirs (Future)
Tertiary Reservoirs (Existing)	

Legend

Provincial Boundaries	
District Municipality Boundaries	
Local Municipality Boundaries	
National Roads	
Main Roads	
Dams & Dam Names	
Rivers	
Settlements	
Major Towns	

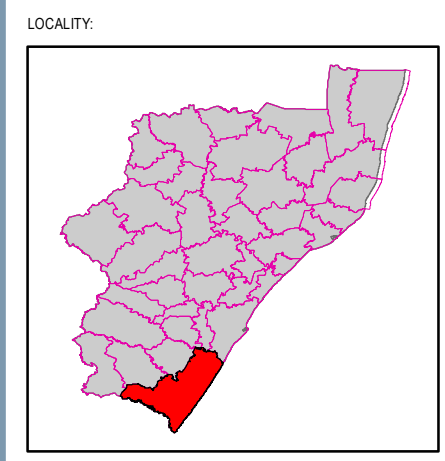

CLIENT:

MUNICIPALITY:

UGU DISTRICT MUNICIPALITY

CONSULTANTS

Project No.: 27814

Mariswe
PO Box 25549, Monument Park
Pretoria, 0105

Tel: +27 (0) 12 424 9700
Fax: +27 (0) 12 460 4071
Email: pretoria@uwp.co.za

PROJECT TITLE

UGU DM: Universal Access Plan Phase III - Progressive Development of a Regional Concept Secondary Bulk Water Master Plan

MAP TITLE:

Total Bulk Water Supply Interventions
UGU District Municipality

DATE COMPLETED:

January 2021

MAP NO.:

DC 21 Figure 9-1

9.1 UG001 WSIA: uMZINTO SCHEME

9.1.1 Demand Model Intervention

9.1.1.1 Water Demand

The water demand for the uMzinto Scheme Area was determined for 2020 and 2050 and included within **Table 9-1** below

Table 9-1: Population and Water demand 2020 and 2050 for the Umzinto Scheme Area

Population	Population 2020	Population 2050
		67 412
Water Demand	Demand 2020 (Mℓ/day)	Demand 2050 (Mℓ/day)
		19.14

9.1.1.2 Water Resource Consideration

Water supply to the uMzinto Scheme is currently sourced from both the Umzinto Dam and EJ Smith Dam. An emergency supply, via E.J. Smith Dam is used as a drought mitigation measure. Water is treated at the 8.9 Mℓ/day Umzinto WTP. The South Coast Pipeline (SCP) Phase 1 pipeline from Quarry reservoir to Scottburgh South provides an additional source of water to the Umzinto Scheme. According to the Umgeni Water 2020 IMP, provision is made for the upgrade of Umzinto WTP to bring the total capacity to 18.2 Mℓ/day.

9.1.2 Water Supply Infrastructure

The following infrastructure upgrades will be required in order to adequately supply Umzinto Scheme Area WSIA and is illustrated within **Figure 9-2** with the schematic layout of the WSIA depicted in **Figure 9-3**.

9.1.2.1 Bulk conveyance and Storage

In this option, the Lower Umkomaas Bulk Water Supply system is the main source of water supply to the uMzinto Scheme area. Water is supplied via a 500mm ø offtake at SCP 1 to supply water to Scottburgh South. Scottburgh South reservoir acts as a balancing reservoir to allow water to be pumped to Ellingham command reservoir. Further off-takes are proposed along the SCP 2b pipeline which will provide 8.34 Mℓ/day to the Freeland park, Park Rynie, Cabana and Umdoni reservoirs. According to the Umgeni Water 2020 IMP, the Umzinto WTP will be used to supply potable water to communities in the adjacent inland areas of Ugu Municipality.

9.1.2.2 Proposed Interventions

No upgrades or interventions are proposed for the Umzinto Scheme Area. The South Coast Pipeline system and LMBWSS will cover the 2050 demand horizon.

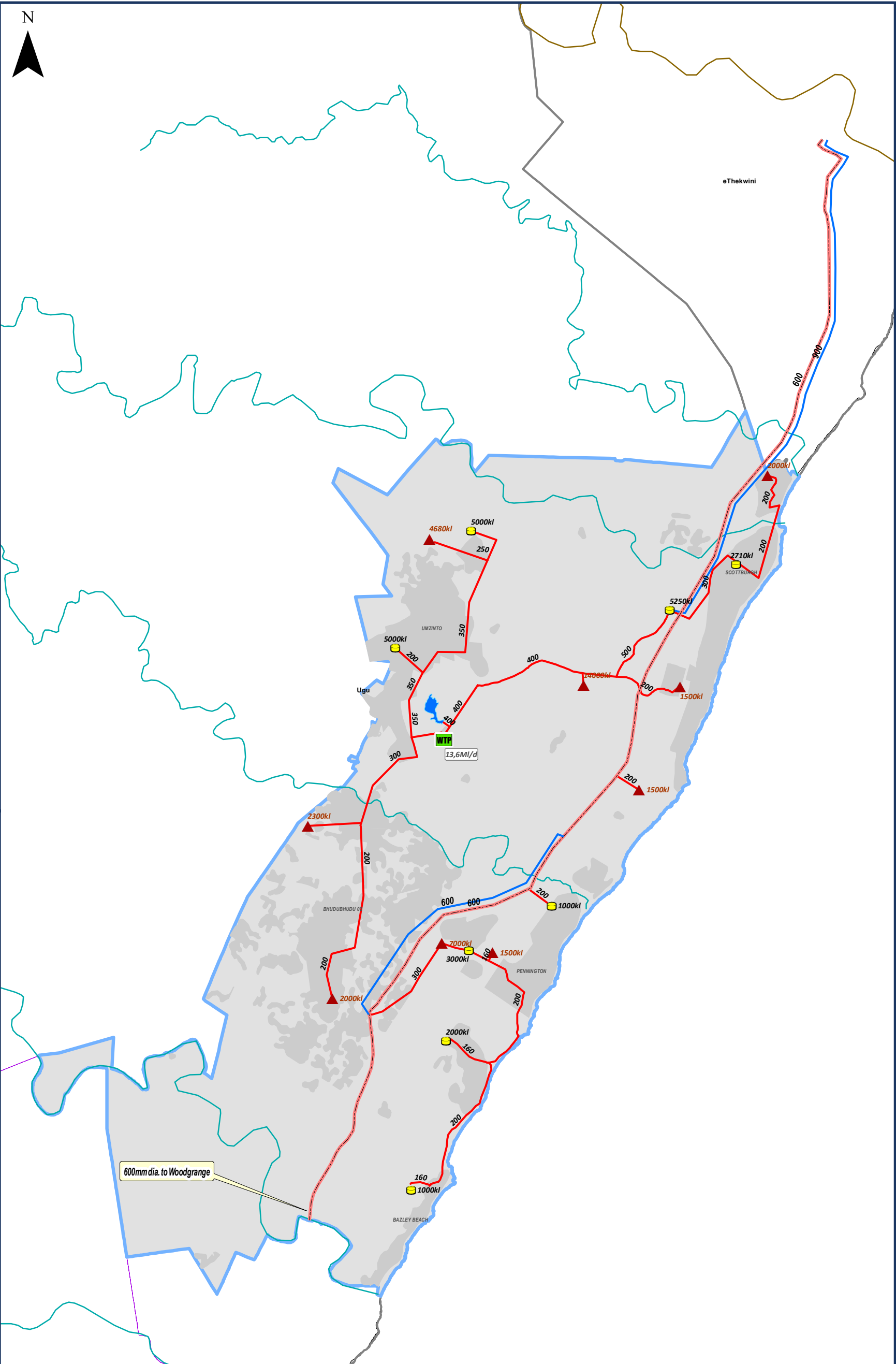

Legend

- Provincial Boundaries
- District Municipality Boundaries
- Local Municipality Boundaries
- National Roads
- Main Roads
- Dams & Dam Names
- Rivers
- Settlements
- Major Towns

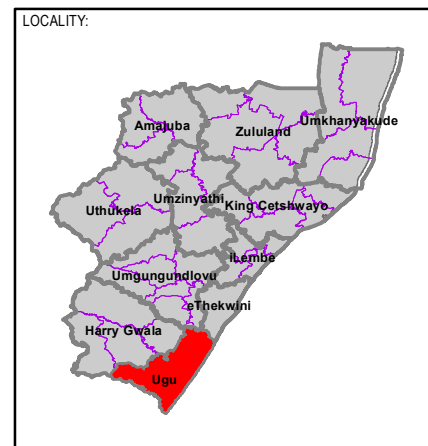

CLIENT:

MUNICIPALITY:

CONSULTANTS

Project No.: 27814

Mariswe
PO Box 25549, Monument Park
Pretoria, 0105

Tel: +27 (0) 12 424 9700
Fax: +27 (0) 12 460 4071
Email: pretoria@uwp.co.za

PROJECT TITLE

Ugu DM: Universal Access Plan Phase III - Progressive Development of a Regional Concept Secondary Bulk Water Master Plan

MAP TITLE:

Total Bulk Water Supply Interventions - UG001: Umzinto Ugu District Municipality

DATE COMPLETED:

January 2021

MAP NO.:

DC 21 Figure 9-2

Proposed New / Upgrade Infrastructure

Water Scheme Areas & Names	Upgrade of WTW
Existing Water Treatment Plants	Surface Water Abstraction Works (Future)
Surface Water Abstraction Works (Existing)	Primary Bulk Pipelines (Future)
Primary Bulk Pipelines (Existing)	Secondary Bulk Pipelines (Future)
Secondary Bulk Pipelines (Existing)	Tertiary Bulk Pipelines (Future)
Tertiary Bulk Pipelines (Existing)	Primary Reservoirs (Existing)
Primary Reservoirs (Existing)	Primary Command Reservoirs (Future)
Secondary Reservoirs (Existing)	Secondary Reservoirs (Future)
Tertiary Reservoirs (Existing)	Tertiary Reservoirs (Future)



Figure 9-3
UG001 WSIA: uMzinto

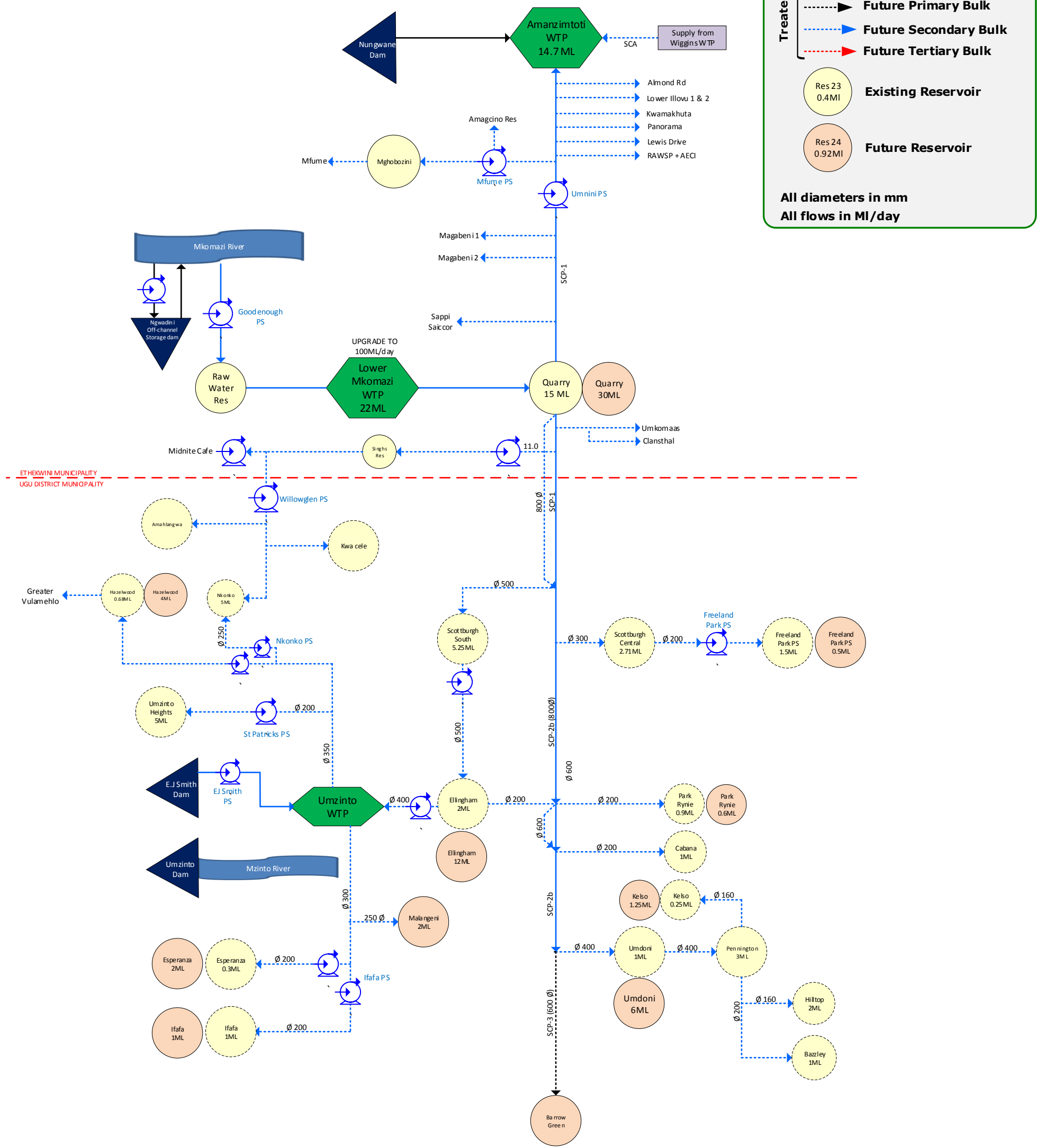

LEGEND

- Raw Water
- Clarified Water
- Existing Primary Bulk
- Existing Secondary Bulk
- Existing Tertiary Bulk
- Future Primary Bulk
- Future Secondary Bulk
- Future Tertiary Bulk
- Existing Reservoir (Res 23 0.4MI)
- Future Reservoir (Res 24 0.92MI)

All diameters in mm
 All flows in MI/day

9.2 UG002 WSIA: uMTWALUME WATER SUPPLY SCHEME

9.2.1 Demand Model Intervention

9.2.1.1 Water Demand

The water demand for uMtwalume WSIA was determined for 2020 and 2050 and included within **Table 9-3**.

Table 9-2: Population and Water demand 2020 and 2050 for uMtwalume WSIA

Population	Population 2020	Population 2050
	74 395	119 504
Water Demand	Demand 2020 (Mℓ/day)	Demand 2050 (Mℓ/day)
	14.87	24.79

9.2.1.2 Water Resource Consideration

The uMtwalume Water Supply Scheme abstracts and treats water from the Mtwalume River for the area referred to as the Middle South Coast, including Bazley, Elysium, Ifafa, parts of Kelso and uMtwalume along the coast and inland areas including the rural areas of Mathulini and kwaQoloqolo. The Mtwalume scheme also gets supply from the Umzinto Scheme via a 200mm Ø pipeline from the Pennington reservoir. This pipeline supplies the iFafa area.

Due to the poor availability of suitable fresh water resources in the uMtwalume Scheme Area where the demand for potable water regularly exceeds the capacity of raw water resources during the dry season, a feasibility study for the Elysium Desalination Project was undertaken by Umgeni Water. This greenfields project intends to supplement potable water supplied by the Mtwalume WTP. The initial capacity of 2.5 Mℓ/day will be increased to 10 Mℓ/day with future development in two or more future phases. Due to the capital and operating expenditures being higher than the South Coast Pipeline Phase 3 project, the desalination project was deferred until required in the future when water resources are exhausted. (UW IMP, 2020)

9.2.2 Water Supply Infrastructure

The following infrastructure upgrades and augmentations will be required in order to adequately supply the uMtwalume WSIA and is illustrated within **Figure 9-4** followed by the schematic layout of the WSIA within **Figure 9-5**.

9.2.2.1 Bulk Conveyance and Storage

- ✓ The uMtwalume WTP pumps water to Ellysium reservoir via 225mmØ pipeline. The Ellysium reservoir has a capacity of 5.5Mℓ
- ✓ The Ellysium reservoir then supplies Mtwalume reservoir via pipelines ranging from 200mmØ to 150mmØ. The Mtwalume reservoir has a capacity of 0.25Mℓ;
- ✓ The Mtwalume reservoir supplies Koelwaters reservoir via a 100mmØ. The Koelwaters reservoir has a capacity of 1Mℓ;

- ✓ The uMtwalume WTP then pumps to Mnafu reservoir via a 250mmØ pipeline. The Mnafu reservoir has a capacity of 3Mℓ;
- ✓ The Mnafu reservoir then supplies Mathulini reservoir via a 350mmØ pipeline. The Mathulini reservoir has a capacity of 0.5Mℓ;
- ✓ The uMtwalume WTP then pumps to Magwaza reservoir via a 100mmØ pipeline. The Magwaza reservoir has a capacity of 0.5Mℓ; and
- ✓ The Magwaza reservoir supplies Inkonxe reservoir via a 100mmØ pipeline. The Inkonxe reservoir has a capacity of 0.5Mℓ.

The South Coast Pipeline Phase 3 (SCP-3) project will supply the scheme with 9.38 Mℓ/day via a 350mm Ø offtake on the 600mm Ø extension from the SCP-2b project. This project will not be sufficient to meet the 2050 demand of the scheme area. The SCP project will require an additional 6.91 Mℓ/day in the interim. The Vulamehlo Dam on the Upper Mtwalume River that will supply the Vulamehlo schemes is a possible resource that can augment the uMtwalume Scheme Area. A feasibility study to increase the yield of the dam for supply down stream to a proposed weir will be required.

The existing storage and bulk system needs to be upgraded for the projected 2050 demand.

9.2.2.2 Proposed Interventions

There is insufficient raw water supply from the Mtwalume River to the uMtwalume WTP to meet the current water demand of the scheme. The intention is to supply the Mtwalume WTP demand node for the proposed SCP Phase 3 once the 400mmØ pipeline is completed. Only then will the following upgrades be possible:

- ✓ The pipeline from uMtwalume WTP to Qoloqolo reservoir needs to be upgraded to 200mmØ pipeline. The Qoloqolo reservoir needs additional storage of 1Mℓ;
- ✓ The pipeline from uMtwalume WTP to Nyangwini reservoir needs to be upgraded to 200mmØ pipeline;
- ✓ A proposed pipeline from Nyangwini reservoir supply reservoirs Nositta, Weza 9 and Amaqhawe 1-2 via pipelines ranging from 75mmØ to 160mm Ø;
- ✓ Areas such as Nomkhanzana, Undadeni, Bobweni and Nkangala will be supplied via the Esperanza reservoir from pipelines ranging from 75mmØ to 160mm Ø;
- ✓ The pipeline from uMtwalume WTP to Ellysium reservoir needs to be upgraded to 400mmØ. The Ellysium reservoir needs additional storage of 6Mℓ by 2050;
- ✓ The pipeline from Ellysium reservoir to uMtwalume reservoir needs to be upgraded to 200mmØ. The uMtwalume reservoir needs additional storage of 1.2Mℓ by 2050;
- ✓ The pipeline from uMtwalume WTP to Mnafu reservoir needs to be upgraded to 500mmØ. The Mnafu reservoir needs additional storage of 8Mℓ by 2050; and
- ✓ The Mathulini reservoir needs additional storage of 4Mℓ by 2050.

9.2.3 Financial Requirements

The bulk cost requirement for uMtwalume WSIA is summarised within **Table 9-4** below.

Table 9-3: UG002 uMtwalume Scheme Cost Requirement

	Capital Cost	10% Contingencies	Total Cost (Excl VAT)
Primary	R11 068 218.66	R1 106 821.87	R12 175 040.53
Secondary	R59 462 400.53	R5 946 240.05	R65 408 640.59
Tertiary	R25 004 042.22	R2 500 404.22	R27 504 446.44
Total	R95 534 661.41	R9 553 466.14	R105 088 127.55

The total bulk cost requirement for the uMtwalume Scheme is R105 088 127.55 (excl VAT). The scheme development cost per household is approximately R 3 400.

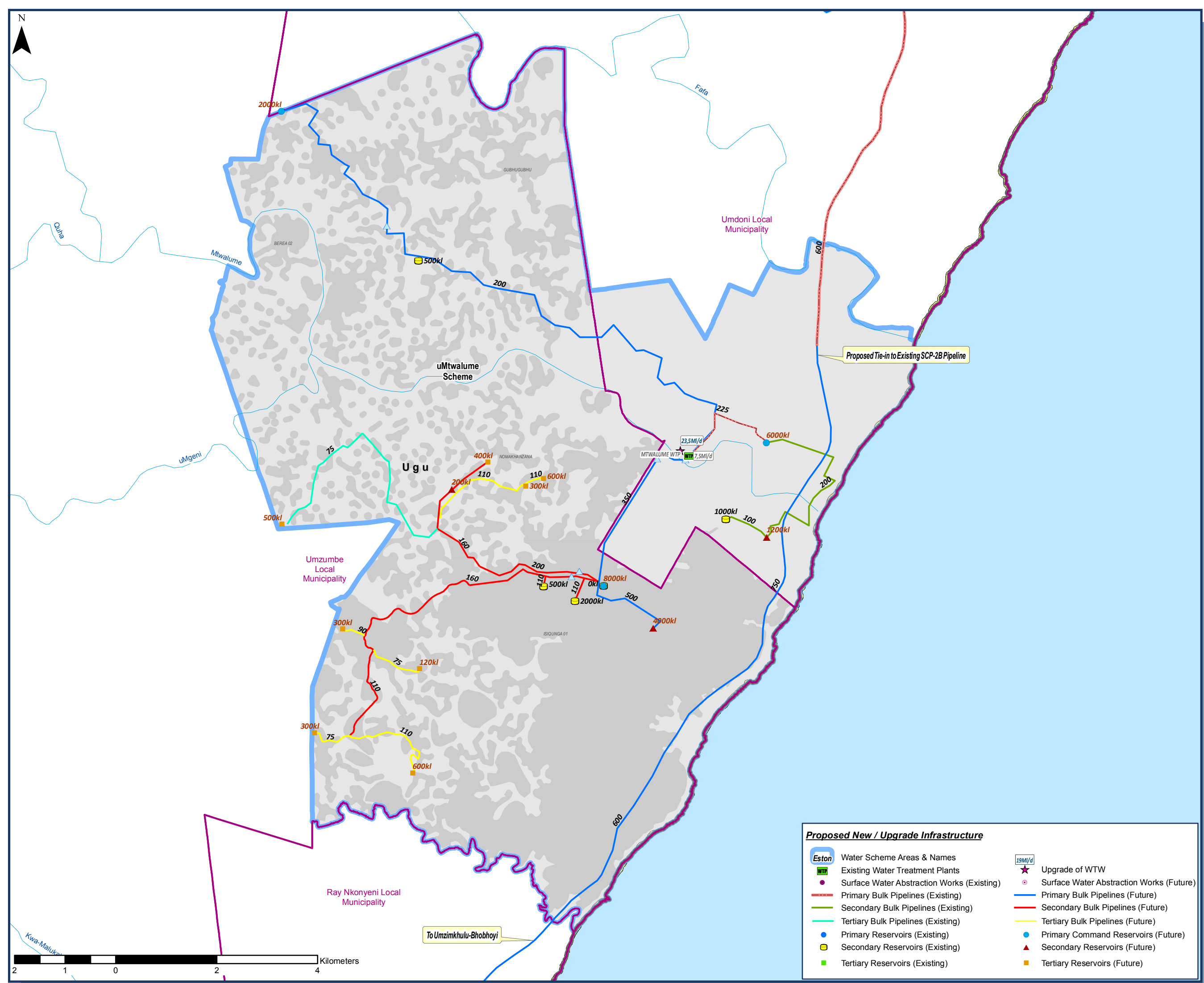

Legend

- Provincial Boundaries
- District Municipality Boundaries
- Local Municipality Boundaries
- National Roads
- Main Roads
- Dams & Dam Names
- Rivers
- Settlements
- Major Towns

LOCALITY:

CLIENT:

MUNICIPALITY:

UGU DISTRICT MUNICIPALITY

CONSULTANTS

Project No.: 27814

Mariswe
PO Box 25549, Monument Park
Pretoria, 0105

Tel: +27 (0) 12 424 9700
Fax: +27 (0) 12 460 4071
Email: pretoria@uwp.co.za

PROJECT TITLE

UGU DM: Universal Access Plan Phase III - Progressive Development of a Regional Concept Secondary Bulk Water Master Plan

MAP TITLE:

Total Bulk Water Supply Interventions - UG000: uMtwalume UGU District Municipality

DATE COMPLETED: January 2021

MAP NO.: DC 21 Figure 9-4

Proposed New / Upgrade Infrastructure

Water Scheme Areas & Names	Upgrade of WTP
Existing Water Treatment Plants	Surface Water Abstraction Works (Future)
Surface Water Abstraction Works (Existing)	Primary Bulk Pipelines (Future)
Primary Bulk Pipelines (Existing)	Secondary Bulk Pipelines (Future)
Secondary Bulk Pipelines (Existing)	Tertiary Bulk Pipelines (Future)
Tertiary Bulk Pipelines (Existing)	Primary Reservoirs (Existing)
Primary Reservoirs (Existing)	Primary Command Reservoirs (Future)
Secondary Reservoirs (Existing)	Secondary Reservoirs (Future)
Tertiary Reservoirs (Existing)	Tertiary Reservoirs (Future)



Figure 9-5
UG002 WSIA: Mtwalume

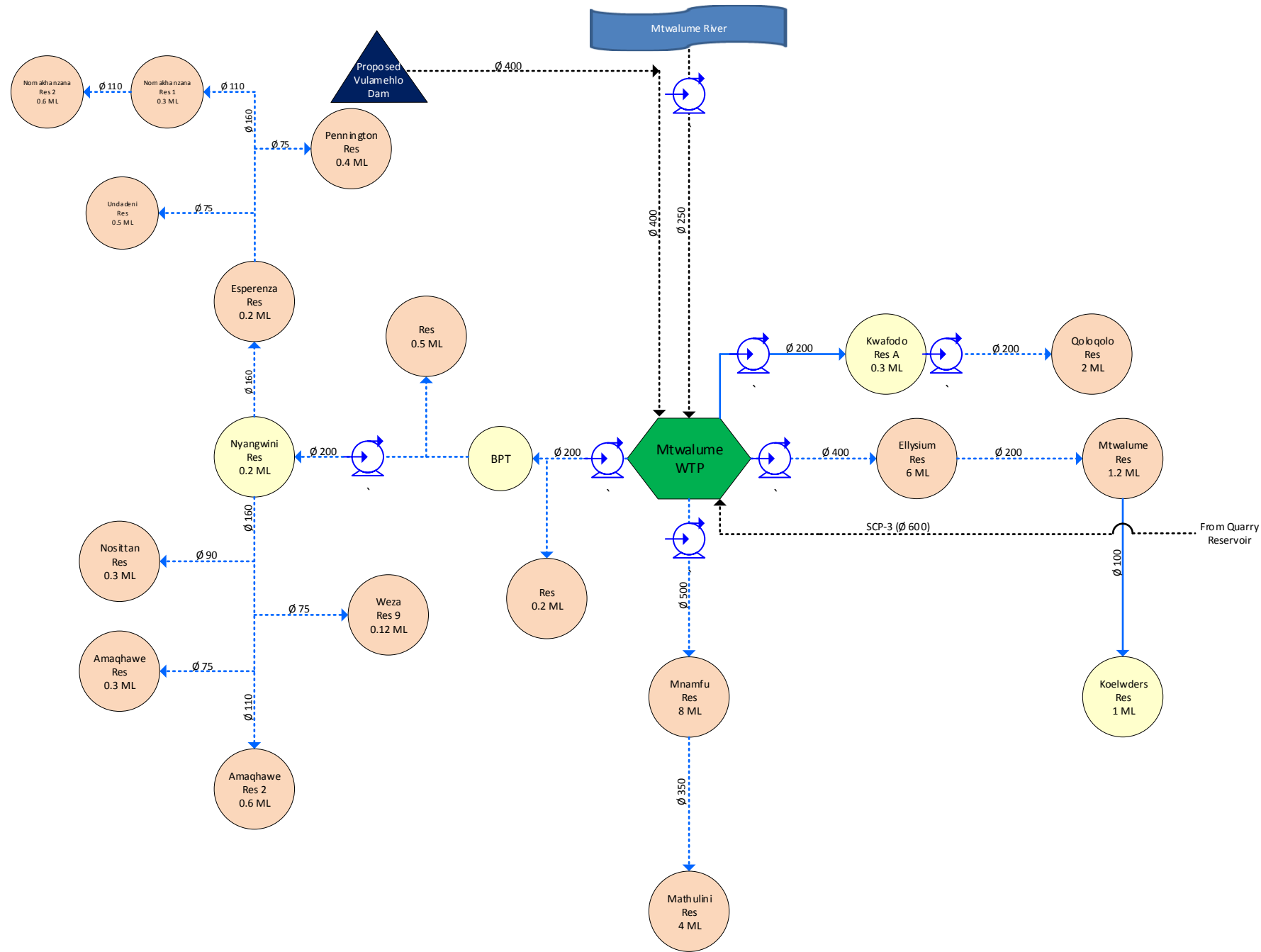

LEGEND

- Raw Water
- Clarified Water
- Treated Water**
 - Existing Primary Bulk
 - Existing Secondary Bulk
 - Existing Tertiary Bulk
 - Future Primary Bulk
 - Future Secondary Bulk
 - Future Tertiary Bulk
- Res 23 (0.4 MI) Existing Reservoir
- Res 24 (0.92 MI) Future Reservoir

All diameters in mm
All flows in MI/day

9.3 UG003 WSIA: uMzIMKHULU/BHOBOHOI SCHEME

9.3.1 Demand Model Intervention

9.3.1.1 Water Demand

The water demand for the uMzimbhulu/Bhobhoi Scheme Area was determined for 2020 and 2050 and included within **Table 9-5** below.

Table 9-4: Population and Water demand 2020 and 2050 for the uMzimbhulu/Bhobhoi WSIA

Population	Population 2020	Population 2050
		224 212
Water Demand	Demand 2020 (Mℓ/day)	Demand 2050 (Mℓ/day)
		63.71

9.3.1.2 Water Resource Consideration

Water supply to the uMzimbhulu/Bhobhoi Scheme is currently sourced from the uMzimbhulu River's St Helen's Rock abstraction works from run-of river yield. The registered use of the existing water resource is 11.5Mm³/a or 31.4 Mℓ/day. The raw water is pumped into the Bhobhoi WTP for treatment and distribution. The WTP has a current capacity of 81 Mℓ/day. However, the plant currently treats 65 Mℓ/day. According to the Umgeni Water IMP, there are plans to increase the WTP capacity to 108 Mℓ/day.

The current water resources for the uMzimbhulu/Bhobhoi WSS will not be able to supply the water requirements for all the communities in 2050. It is therefore necessary to explore the feasibility of other options such as upgrading the current water source or find new water sources.

Ncwabeni OCS Dam

Planning for the Ncwabeni off channel storage Dam is at an advanced stage. The dam is located on the Ncwabeni River which is a tributary of the uMzimbhulu river. The Ncwabeni Dam Feasibility Study (2012) indicates that the yield of the uMzimbhulu River for the Bhobhoi WTP can assure 83 Mℓ/day supply. This yield is achievable with the construction of a diversion weir on the uMzimbhulu river and a pumping scheme into the Ncwabeni off-channel storage dam.

9.3.2 Water Supply Infrastructure

The following infrastructure upgrades will be required in order to adequately supply uMzimbhulu/Bhobhoi Scheme Area WSIA and is illustrated within **Figure 9-6** with the schematic layout of the WSIA depicted in **Figure 9-7**.

9.3.2.1 Bulk conveyance and Storage

A proposed weir on the uMzimkhulu River at St. Helens Rock which will be fed by the Ncwabeni OCS Dam during the dry seasons will provide an assured supply of 83 Mℓ/day. Raw water will then be abstracted from the weir and conveyed to the Bhobhoi WTP. The proposed weir will need to be implemented as soon as possible in order to address the shortfall for the uMzimkhulu/Bhobhoi Scheme Area. The 2050 demand in the uMzimkhulu/Bhobhoi Scheme area is projected to be 104.63 Mℓ/day which results in a shortfall of approximately 22 Mℓ/day. The following two options will address this shortfall:

- ✓ The South Coast Pipeline Phase 3 (SCP-3) will supply the Woodgrange Reservoir (111m) with 10 Mℓ/day that will distribute to the Umtentweni, Chabane and Hibberdene areas. The extension of SCP-3 is a 600mm \varnothing gravity main.
- ✓ An additional 12 Mℓ/day will be supplied from the uMtamvuna Scheme Area to augment the supply of the Umzimkhulu/Bhobhoi Scheme Area. A 12km, 400 mm \varnothing rising main from the Southbroom Reservoir (94m) to the Margate 2A reservoir (119m) will augment supply to the southern area of the scheme. Off-takes on this pipeline will make it possible to feed the Ramsgate North and Ramsgate South 4A reservoirs.

The existing Bhobhoi WTP, storage reservoirs and secondary pipeline infrastructure will be upgraded to meet the projected 2050 demand.

9.3.2.2 Proposed Interventions

In order to meet the 2050 demand, the following interventions must be implemented:

- ✓ Implementation of the Ncwabeni OCS Dam
- ✓ Proposed weir on the uMzimkhulu River at St. Helens Rock
- ✓ A 30km proposed 600mm \varnothing bulk water supply pipeline from Umdoni reservoir to Woodgrange reservoir;
- ✓ Upgrade the existing pipeline between Bhobhoi WTP and Murchison Res 2 to 400mm \varnothing ;
- ✓ Upgrade the existing pipeline between Murchison Res 2 to Murchison Res 3 to 350mm \varnothing ;
- ✓ Upgrade the existing pipeline between Bhobhoi WTP and Gamalakhe reservoir to 500mm \varnothing ;
- ✓ Upgrade the existing pipeline between Gamalakhe reservoir and Nositha reservoir to 200mm \varnothing ;
- ✓ Proposed 200mm \varnothing off-take to Nositha South; and
- ✓ Additional storage capacity will be required at Murchison, Gamalakhe, Bomela, Bhobhoi, Ezperanza and Margate.

Design details of all the infrastructure components are provided within **Annexure B**.

9.3.3 Financial Requirements

The bulk cost requirement for the uMzimkhulu/Bhobhoyi Scheme WSIA is summarised within **Table 9-6** below.

Table 9-5: UG003 uMzimkhulu/Bhobhoyi Scheme Cost Requirement

	Capital Cost	10% Contingencies	Total Cost (Excl VAT)
Primary	R498 184 221.00	R49 818 422.10	R548 002 643.10
Secondary	R73 554 946.79	R7 355 494.68	R80 910 441.47
Tertiary	R4 070 593.57	R407 059.36	R4 477 652.93
Total	R575 809 761.36	R57 580 976.14	R633 390 737.50

The total bulk cost requirement for the uMzimkhulu/Bhobhoyi Scheme is R633 390 737.50 (excl VAT). The scheme development cost per household is approximately R 10 500.

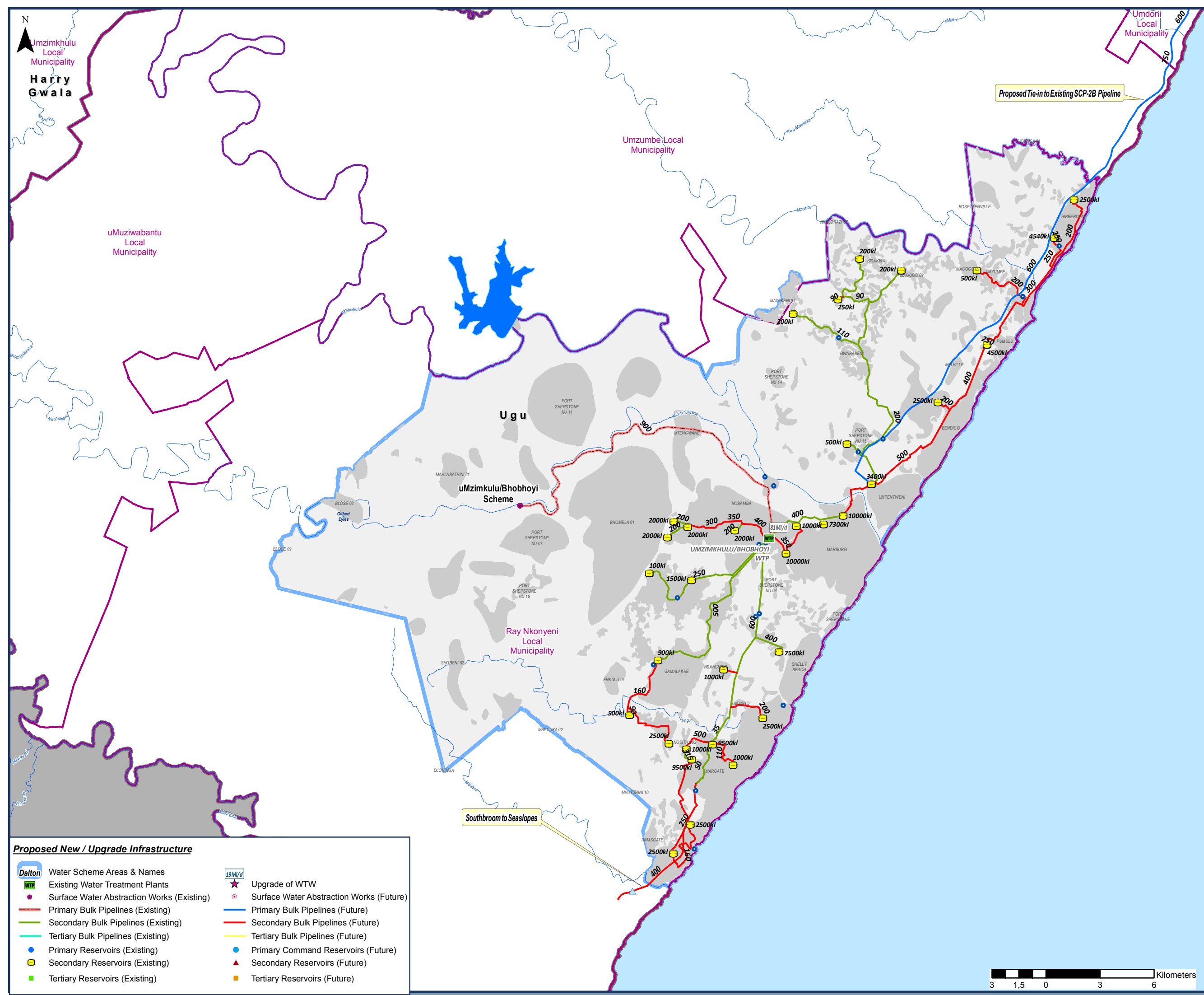

Legend

- Provincial Boundaries
- District Municipality Boundaries
- Local Municipality Boundaries
- Dams & Dam Names
- Rivers
- Settlements
- Major Towns

LOCALITY:

CLIENT:

MUNICIPALITY:

UGU DISTRICT MUNICIPALITY

CONSULTANTS

Project No.: 27814

Mariswe
PO Box 25549, Monument Park
Pretoria, 0105

Tel: +27 (0) 12 424 9700
Fax: +27 (0) 12 460 4071
Email: pretoria@uwp.co.za

PROJECT TITLE

UGU DM: Universal Access Plan Phase III - Progressive Development of a Regional Concept Secondary Bulk Water Master Plan

MAP TITLE:

Total Bulk Water Supply Interventions - UG003: Umzimkhulu - Bhobhoi UGU District Municipality

DATE COMPLETED:

January 2021

MAP NO.:

DC 21 Figure 9-6

Proposed New / Upgrade Infrastructure

Water Scheme Areas & Names	Upgrade of WTW
Existing Water Treatment Plants	Surface Water Abstraction Works (Future)
Surface Water Abstraction Works (Existing)	Primary Bulk Pipelines (Future)
Primary Bulk Pipelines (Existing)	Secondary Bulk Pipelines (Future)
Secondary Bulk Pipelines (Existing)	Tertiary Bulk Pipelines (Future)
Tertiary Bulk Pipelines (Existing)	Primary Command Reservoirs (Future)
Primary Reservoirs (Existing)	Secondary Reservoirs (Future)
Secondary Reservoirs (Existing)	Tertiary Reservoirs (Future)
Tertiary Reservoirs (Existing)	



Figure 9-7
UG003 WSIA: UMZIMKHULU/BHOBOYOI SCHEME

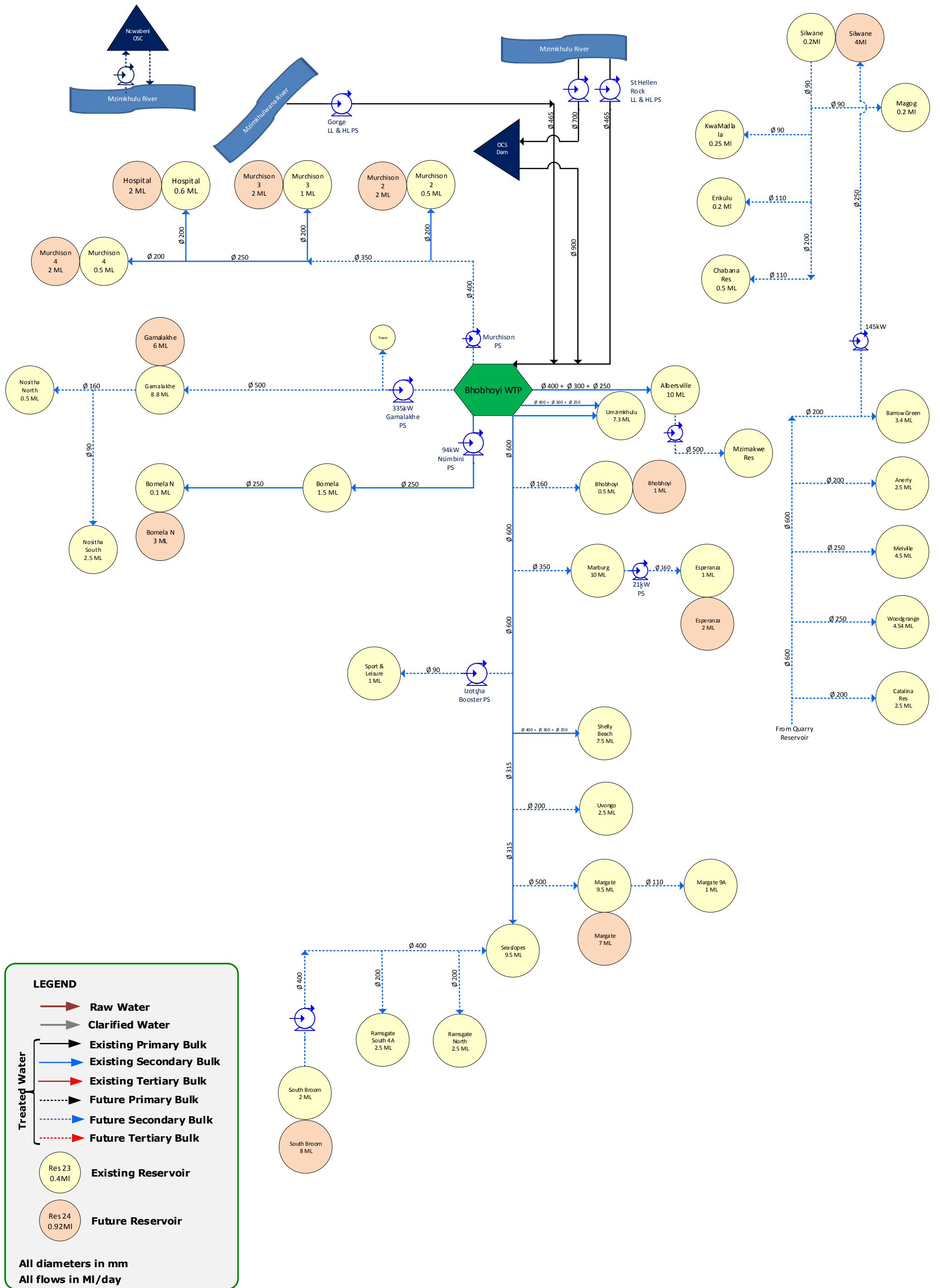

9.4 UG004 WSIA: UMTAMVUNA WATER SUPPLY SCHEME

9.4.1 Demand Model Intervention

9.4.1.1 Water Demand

The water demand for the uMtamvuna Scheme was determined for 2020 and 2050 and included within **Table 9-7** below.

Table 9-6: Population and Water demand 2020 and 2050 for the uMtamvuna Scheme

Population	Population 2020	Population 2050
	134978	216819,8
Water Demand	Demand 2020	Demand 2050
	26.16	43.72

9.4.1.2 Water Resource Consideration⁹

The uMtamvuna Water Supply Scheme abstracts and treats water from the uMtamvuna River for the inland areas of Eziqoleni, kwaXolo, MkwaShoba/Mdlazi, and kwaShoben as well as the coastal strip from Ramsgate to Port Edward.

Raw water is pumped from an abstraction works located in the uMtamvuna River to the uMtamvuna WTP, via an off-channel storage dam (180 Mℓ storage capacity) to the Mtamvuna WTP. The capacity of the uMtamvuna WTP has recently been increased from 20 Mℓ/day to 50 Mℓ/day.

The raw water abstraction point has a yield of 33Mℓ/day, hence a current surplus of 5Mm³/a (13.7Mℓ/day).

The current and planned resources of the Umtamvuna WSS will be adequate to supply the water requirements for all the communities in 2050.

9.4.2 Water Supply Infrastructure

9.4.2.1 Bulk conveyance and Storage

Raw water is pumped, via one stage pumping, from the Umtamvuna River abstraction point to the Umtamvuna WTP. Potable water is then pumped from the WTP (522m), via a ø 500 mm pumping main to the 0.25 Mℓ Florida (balancing) Reservoir (538 m).

From Florida Reservoir water is pumped to 3No. upgraded reservoirs i.e. to the 1.4 Mℓ Shoba Reservoir (591m) through a ø 150mm pipeline, to the 0.5 Mℓ Modelane (balancing) Reservoir through ø 250mm pipeline and to the 1.2 Mℓ Kwaxolo (balancing) Reservoir through a ø 300mm pipeline.

⁹Sourced from Umgeni IMP 2020

From the Modelane Reservoir (554m) water is supplied to the 5Mℓ Izingolweni Reservoir (630m) via a 250mm \varnothing rising main from where it will be pumped via a 150 mm \varnothing pumping main to the 0.5 Mℓ Shobeni Reservoir.

From Kwaxolo Reservoir (442m) water will be supplied via gravity to the areas of Gcilima and Mvutshini. From the 0.5Mℓ Mvutshini (balancing) Reservoir(332m), water is pumped to the 0.5 Mℓ Mbecuka Reservoir (503m).

Umtamvuna WTP distributes water via gravity to 5 Mℓ BP1 (balancing) Reservoir (246m) through a \varnothing 400 mm pipeline, then from BP1 Reservoir water gravitates to 5 Mℓ BP2 Reservoir (165m) through a \varnothing 400 mm pipeline. BP2 Reservoir distributes water to storage reservoirs via secondary and tertiary distribution mains to supply the Glenmore, Trafalgar, Sanlameer, Southbroom, Leisure Bay, Port Edward, Banmers Rest, New Banmers Rest and Upper Banmers Rest areas.

9.4.2.2 Proposed interventions

The following infrastructure will be required to adequately supply the Umtamvuna Scheme and surrounding areas and is illustrated within **Figure 9-8** followed by the schematic layout of the WSIA within **Figure 9-9**.

- ✓ The existing abstraction works will need to be upgraded to cater for 45Mℓ/day;
- ✓ The existing raw water pipeline to Umtamvuna WTP will need to be upgraded to \varnothing 800 mm pipeline to meet 2050 demand;
- ✓ The existing WTP will need to be upgraded to 45Mℓ/day;
- ✓ The existing Shoba Reservoir will need to be upgraded to 1.4 Mℓ/day to cater for the 2050 demand;
- ✓ The existing Izingolwemi Reservoir will need to be upgraded to 5 Mℓ/day to cater for the 2050 demand;
- ✓ The existing Shobeni Reservoir will need to be upgraded to 0.5 Mℓ/day;
- ✓ The existing Mbecuka Reservoir will need to be upgraded to 0.5 Mℓ/day;
- ✓ The existing Kwaxolo Reservoir will need to be upgraded to 1.2 Mℓ/day to cater for the 2050 demand;
- ✓ The existing Gcilimare Reservoir will need to be upgraded to 4 Mℓ/day;
- ✓ The existing Nzimakwe Reservoir 1 will need to be upgraded to 0.65 Mℓ/day;
- ✓ The existing Nzimakwe Reservoir 2 will need to be upgraded to 0.65 Mℓ/day to cater for the 2050 demand;
- ✓ The existing Kwalatshoda/Nzimakwe Reservoir will need to be upgraded to 2 Mℓ/day;
- ✓ The existing pipeline to Kwalembe Reservoir one will need to be upgraded to \varnothing 250 mm pipeline to meet the 2050 demand;
- ✓ The existing pipeline to Florida Reservoir will need to be upgraded to \varnothing 500 mm pipeline;
- ✓ The existing pipeline to Modelane Reservoir will need to be upgraded to \varnothing 250 mm pipeline;
- ✓ The existing pipeline to Izingolweni Reservoir will need to be upgraded to \varnothing 250 mm pipeline;
- ✓ The existing pipeline to Kwaxolo Reservoir will need to be upgraded to \varnothing 300 mm pipeline ;
- ✓ The existing pipeline to Gcilimare Reservoir will need to be upgraded to \varnothing 300 mm pipeline;
- ✓ The existing pipeline to Mvutshini Reservoir will need to be upgraded to \varnothing 200 mm pipeline;
- ✓ The existing pipeline to Nzimakwe Reservoir 2 will need to be upgraded to \varnothing 200 mm pipeline;

- ✓ The existing pipeline to Nzimakwe Reservoir 1 will need to be upgraded to ø 90 mm pipeline; and.
- ✓ The existing pipeline to Kwalatshoda/Nzimakwe Reservoir will need to be upgraded to ø 200 mm pipeline to meet the 2050 demand.

Design details of all the infrastructure components are provided within **Annexure B**.

9.4.3 Financial Requirements

The bulk cost requirement for uMtamvuna Scheme is summarised within **Table 9-8** below.

Table 9-7: UG004 uMtamvuna Scheme Cost Requirement

	Capital Cost	10% Contingencies	Total Cost (excl VAT)
Primary	R152 111 998.58	R15 211 199.86	R167 323 198.44
Secondary	R165 757 765.44	R16 575 776.54	R182 333 541.98
Tertiary	R34 401 229.91	R3 440 122.99	R37 841 352.90
Total	R352 270 993.93	R35 227 099.39	R387 498 093.32

The total bulk cost requirement for the uMtamvuna Scheme is R387 498 093.32 (excl VAT). The scheme development cost per household is approximately R 10 700.

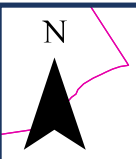

Legend

- Provincial Boundaries
- District Municipality Boundaries
- Local Municipality Boundaries
- National Roads
- Main Roads
- Dams & Dam Names
- Rivers
- Settlements
- Major Towns

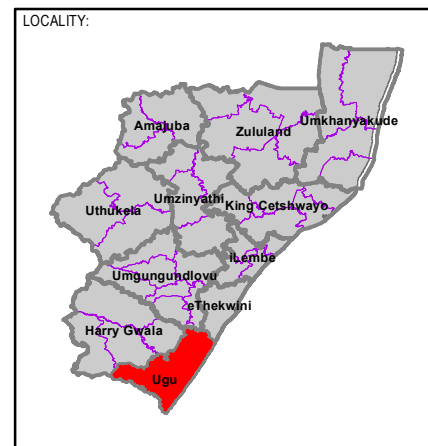
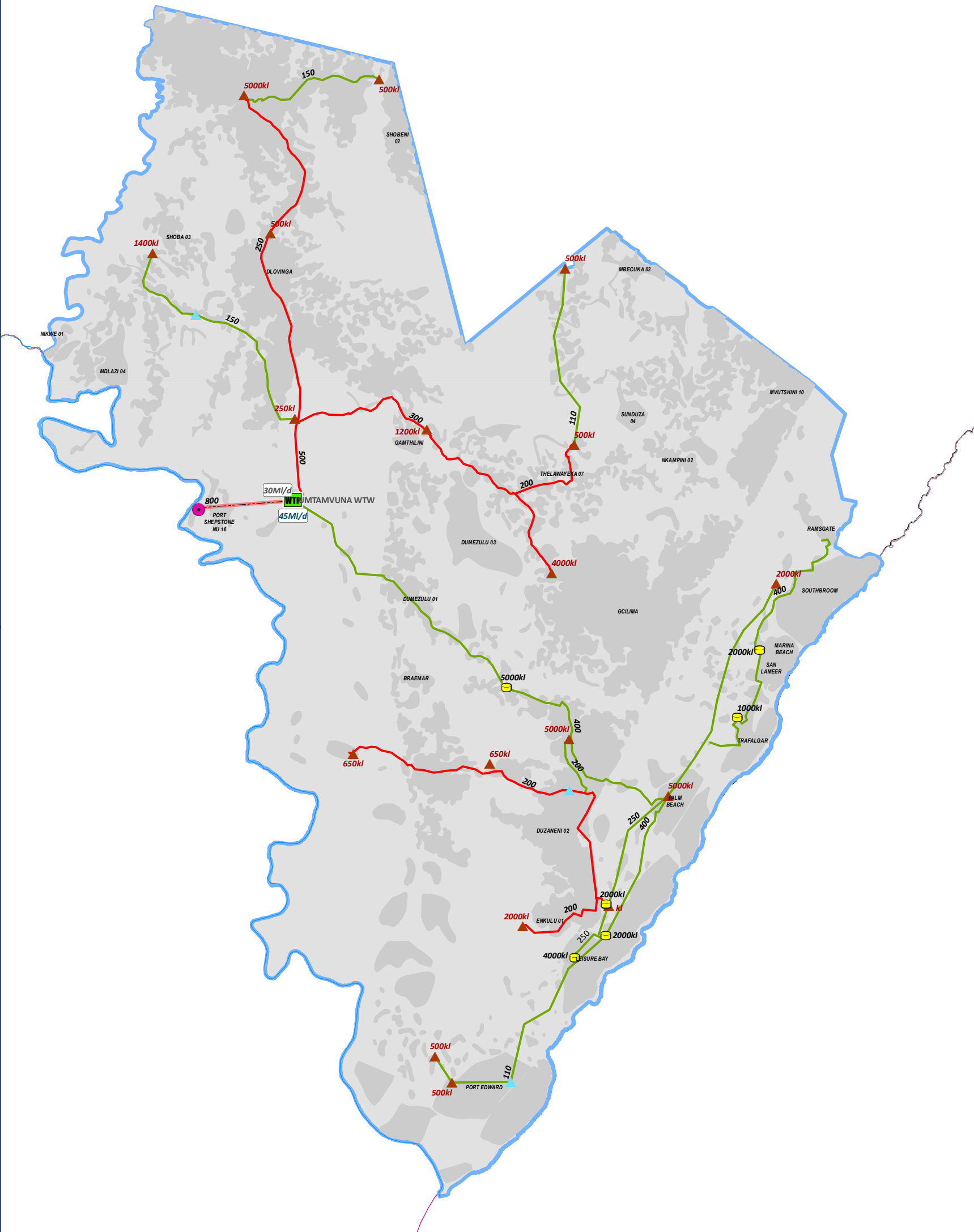

CLIENT:

MUNICIPALITY:

UMGUNGUNDLOVU DISTRICT MUNICIPALITY

CONSULTANTS

Project No.: 27814

Mariswe
PO Box 25549, Monument Park
Pretoria, 0105

Tel: +27 (0) 12 424 9700
Fax: +27 (0) 12 460 4071
Email: pretoria@uwp.co.za

PROJECT TITLE

Ugu DM: Universal Access Plan Phase III - Progressive Development of a Regional Concept Secondary Bulk Water Master Plan

MAP TITLE:

Total Bulk Water Supply Interventions - UG004: uMtamvuna Ugu District Municipality

DATE COMPLETED:

January 2021

MAP NO.:

DC 21 Figure 9-8

Proposed New / Upgrade Infrastructure

Water Scheme Areas & Names	Existing Water Treatment Plants	Upgrade of WTW
Surface Water Abstraction Works (Existing)	Surface Water Abstraction Works (Future)	
Primary Bulk Pipelines (Existing)	Primary Bulk Pipelines (Future)	
Secondary Bulk Pipelines (Existing)	Secondary Bulk Pipelines (Future)	
Tertiary Bulk Pipelines (Existing)	Tertiary Bulk Pipelines (Future)	
Primary Reservoirs (Existing)	Primary Command Reservoirs (Future)	
Secondary Reservoirs (Existing)	Secondary Reservoirs (Future)	
Tertiary Reservoirs (Existing)	Tertiary Reservoirs (Future)	



Figure 9-9
UG004 WSIA: uMtamvuna scheme

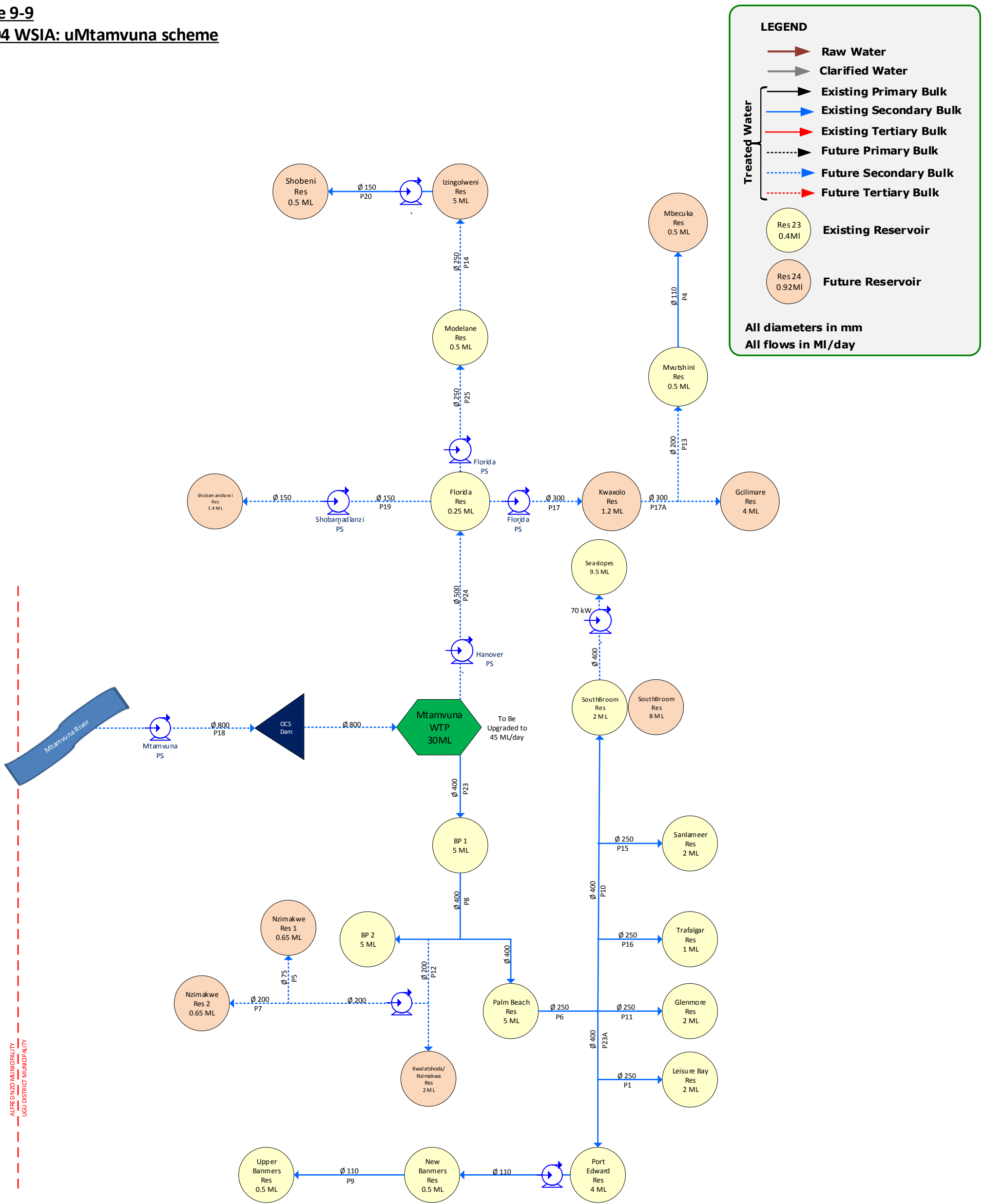

9.5.1 Demand Model Intervention

9.5.1.1 Water Demand

The water demand for the Harding/Weza Bulk Water Supply was determined for 2020 and 2050 and included within **Table 9-9** below.

Table 9-8: Population and Water demand 2020 and 2050 for the Harding/Weza BWSS

Population	Population 2020	Population 2050
		154 059
Water Demand	Demand 2020 (Mℓ/day)	Demand 2050 (Mℓ/day)
		22.14

9.5.1.2 Water Resource Consideration¹⁰

The Harding/Weza Water Supply Scheme abstracts and treats water from the Weza River and the Harding Dam. The scheme supplies the rural areas of KwaMachi, kwaJali, kwaMthimude and the town of Harding. Progressively, the scheme has also been extended to incorporate the areas of kwaMbotho and kwaFodo. The intention is to decommission the existing kwaFodo, kwaMbotho and kwaNyuswa WTP’s and supply the areas covered by these WTP’s from the Harding/Weza WTP.

The current and planned resources for the Harding/Weza WSS will not be able to supply the water requirements for all the communities in 2050. It is therefore necessary to either upgrade the existing water source or explore alternative water resources.

Weza Dam

Planning for the Weza Dam is in advanced stages. The current reports indicate that the dam will increase the yield of the abstraction point to 11.8Mℓ/day. This will be inadequate for the calculated 2050 demand of 44Mℓ/day. It is therefore proposed to look at alternative sources for augmenting water supply to the Harding/Weza Scheme.

Gundrift Weir on the uMtamvuna River

An existing weir on the uMtamvuna River at Gundrift is a possible option to supply the Harding/Weza Scheme. A hydrological study will need to be undertaken in order to determine if the available yield will be sufficient to meet the 2050 demands.

¹⁰ Sourced from the Umgeni Water IMP, 2020 and UAP Phase II

9.5.2 Water Supply Infrastructure

The following infrastructure upgrades and augmentation will be required in order to adequately supply the Harding/Weza Scheme WSIA and is illustrated within **Figure 9-10** followed by the schematic layout of the WSIA within **Figure 9-11**.

9.5.2.1 Bulk conveyance and Storage

Gundrift Weir on the uMtamvuna River

If the yield of the weir allows, raw water will be abstracted from the weir and conveyed to a proposed 30 Mℓ raw water storage reservoir (1 066m) via a 600mm \varnothing rising main. Raw water can then be conveyed to both the Weza and Harding WTP's via a 350mm \varnothing and 500mm \varnothing gravity main respectively. A dam site on the Mtamvuna River upstream of the Gundrift Weir (Dam 6) was investigated in a feasibility study undertaken by Iliso Consulting in 2006 for the Southern Regional Schemes for Umgeni Water. The study indicates that the dam will have a capacity of 32Mm³ and yield 25.2 Mℓ/day. A hydrological study to confirm the yield of this dam will be required to ascertain if the dam can release sufficient water for abstraction at the weir downstream. The dam and weir can also augment the north-eastern areas of the Eastern Cape if there is sufficient yield.

New Biggen Regional Scheme

From the proposed Kwanongidi Command Reservoir on the proposed new Biggen Regional Scheme, it will be possible to supply water under gravity to the Weza and Harding demand nodes via pipelines ranging from 700mm \varnothing to 500mm \varnothing .

From the Weza WTP, water will be pumped in two (2) directions, pumping to 0.5 Mℓ Jali Reservoir (1034 m) through a 250mm \varnothing bulk rising main and pumping to the 11 Mℓ Kwezi Reservoir (1056 m) through a 500mm \varnothing bulk rising main.

From Jali Reservoir water is pumped to 0.1 Mℓ Bazini Reservoir (1179m) via \varnothing 150mm rising main. Water will then be distributed to storage reservoirs via secondary and tertiary distribution mains (pipe sizes ranging from 75 mm \varnothing to 250 mm \varnothing) to supply the Mbizweni, Bhudlu, Reedsdell, Ngqolo, Ingele, and Kwabhubesi areas.

From Khwezi Reservoir, water will be conveyed via a \varnothing 400mm to the Machi Reservoir (973m) that supplies water to the areas of Elim, Mlozane, Qweleba, Mbangweni, Nombengeza, Nhlanza and Gangala. Water will also gravitate from the Khwezi Command Reservoir to the Harding WTP via \varnothing 400mm gravity main from where it will be transferred to the Harding Reservoir (901m). The Harding Reservoir supplies Harding town via gravity and the rural areas of KwaFodo, KwaMbotho and KwaNyuswa via \varnothing 300mm pumping main. The Eastern areas of the Weza Scheme will also be supplied via the Khwezi Command Reservoir.

9.5.2.2 Proposed interventions

- ✓ Construction of Dam 6 & Abstraction works on the Umtamvuna River at Gundrift;
- ✓ The existing Weza WTP needs to be upgraded to 10 Ml/day;
- ✓ The existing Harding WTP needs to be upgraded to 18 Ml/day;
- ✓ A 600mm ø raw water rising main
- ✓ A 30 Ml raw water reservoir
- ✓ Proposed 350mm ø and 500mm ø gravity mains
- ✓ The existing Mlozane Reservoir will need to be upgraded to 3 Ml/day to cater for the 2050 demand;
- ✓ The existing ø 150 mm pipeline to Jali and Bazini will need to be upgraded to ø 250 mm pipeline;
- ✓ The existing ø 350 mm pipeline to Khwezi Reservoir will need to be upgraded to ø 500 mm pipeline;
- ✓ The existing ø 200 mm pipeline to Kwamachi Reservoir will need to be upgraded to ø 400 mm pipeline to meet 2050 demand
- ✓ The existing ø 200 mm pipeline to Elimi Reservoir will need to be upgraded to ø 250 mm pipeline;
- ✓ The existing ø 160 mm pipeline to Mlozane Reservoir will need to be upgraded to ø 200 mm pipeline;
- ✓ The existing ø 250 mm pipeline to Harding WTP will need to be upgraded to ø 400 mm pipeline;
- ✓ The existing ø 200 mm pipeline to KwaFodo Reservoir N2 will need to be upgraded to ø 300 mm;
- ✓ The existing ø 110 mm pipeline to KwaFodo Reservoir N will need to be upgraded to ø 160 mm;
- ✓ The proposed pipeline from Kokstad to Weza will need to be ø 350 mm,.
- ✓ The proposed pipeline from Kwanongidi Reservoir to Harding WTP Clear Water Reservoir will be 700mm ø; and
- ✓ The offtake on the Kwanongidi to Harding pipeline that will supply Weza will be 600mm ø to meet the 2050 demand

Design details of all the infrastructure components are provided within **Annexure B**.

9.5.3 Financial Requirements

The bulk cost requirement for Harding/Weza Scheme is summarised within **Table 9-10** below.

Table 9-9: UG005 Harding/Weza Scheme Cost Requirement

	Capital Cost	10% Contingencies	Total Cost (excl VAT)
Primary	R2 493 761 308.23	R249 376 130.82	R2 743 137 439.05
Secondary	R236 932 425.60	R23 693 242.56	R260 625 668.16
Tertiary	R60 025 541.15	R6 002 554.12	R66 028 095.27
Total	R2 790 719 274.98	R279 071 927.50	R3 069 791 202.48

The total bulk cost requirement for the Harding/Weza Scheme is R3 069 791 202.48 (excl VAT). The scheme development cost per household is approximately R 98 000.

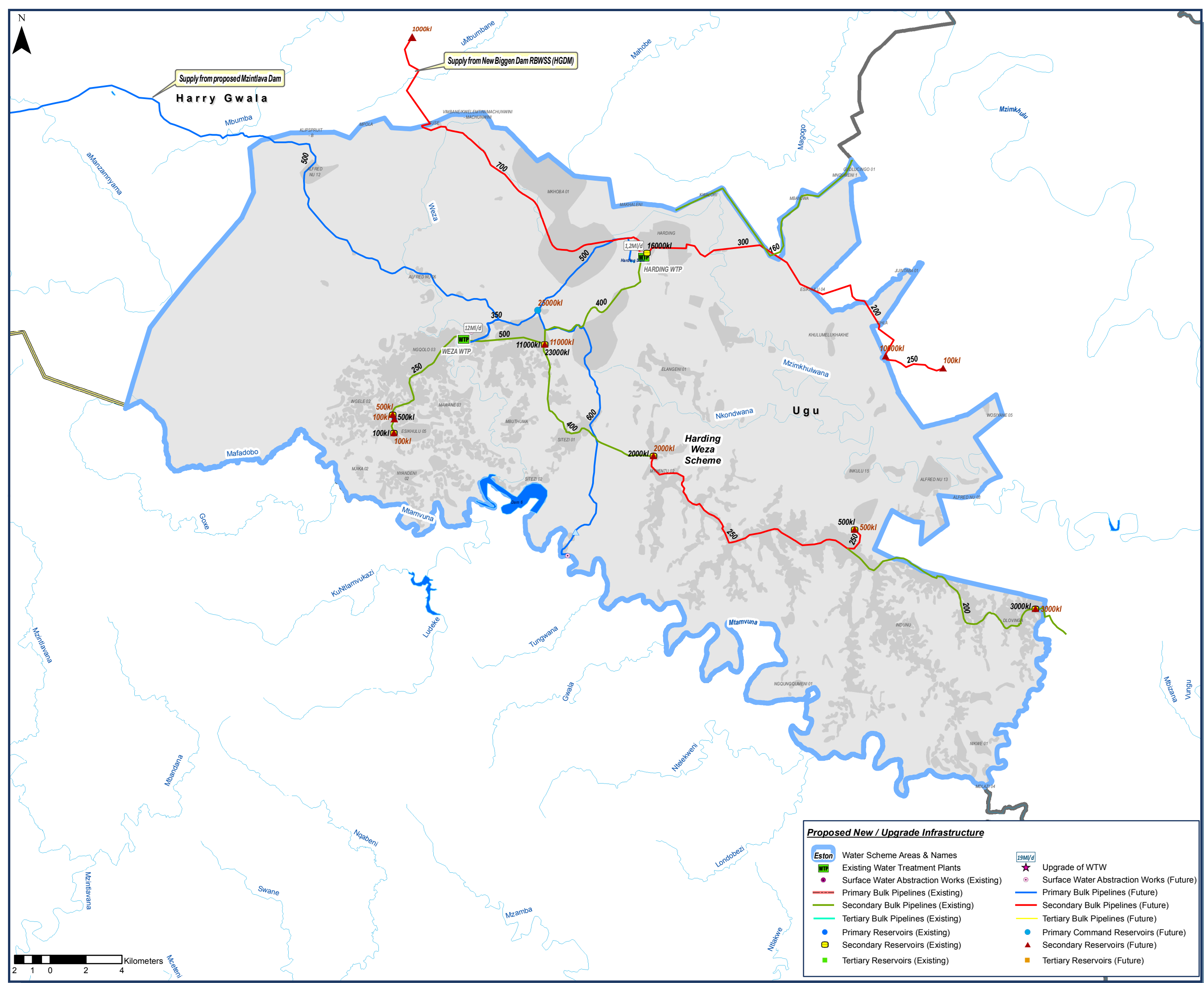

Legend

- Provincial Boundaries
- District Municipality Boundaries
- Local Municipality Boundaries
- National Roads
- Main Roads
- Dams & Dam Names
- Rivers
- Settlements
- Major Towns

LOCALITY:

CLIENT:

MUNICIPALITY:

UGU DISTRICT MUNICIPALITY

CONSULTANTS

Project No.: 27814

Mariswe
PO Box 25549, Monument Park
Pretoria, 0105

Tel: +27 (0) 12 424 9700
Fax: +27 (0) 12 460 4071
Email: pretoria@uwp.co.za

PROJECT TITLE

UGU DM: Universal Access Plan Phase III - Progressive Development of a Regional Concept Secondary Bulk Water Master Plan

MAP TITLE:

Total Bulk Water Supply Interventions - UG005: Harding-Weza UGU District Municipality

DATE COMPLETED:

30 September 2020

MAP NO.:

DC 21 Figure 9-10

Proposed New / Upgrade Infrastructure

Water Scheme Areas & Names	Upgrade of WTW
Existing Water Treatment Plants	Surface Water Abstraction Works (Future)
Surface Water Abstraction Works (Existing)	Primary Bulk Pipelines (Future)
Primary Bulk Pipelines (Existing)	Secondary Bulk Pipelines (Future)
Secondary Bulk Pipelines (Existing)	Tertiary Bulk Pipelines (Future)
Tertiary Bulk Pipelines (Existing)	Primary Reservoirs (Existing)
Primary Reservoirs (Existing)	Primary Command Reservoirs (Future)
Secondary Reservoirs (Existing)	Secondary Reservoirs (Future)
Tertiary Reservoirs (Existing)	Tertiary Reservoirs (Future)

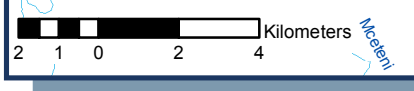
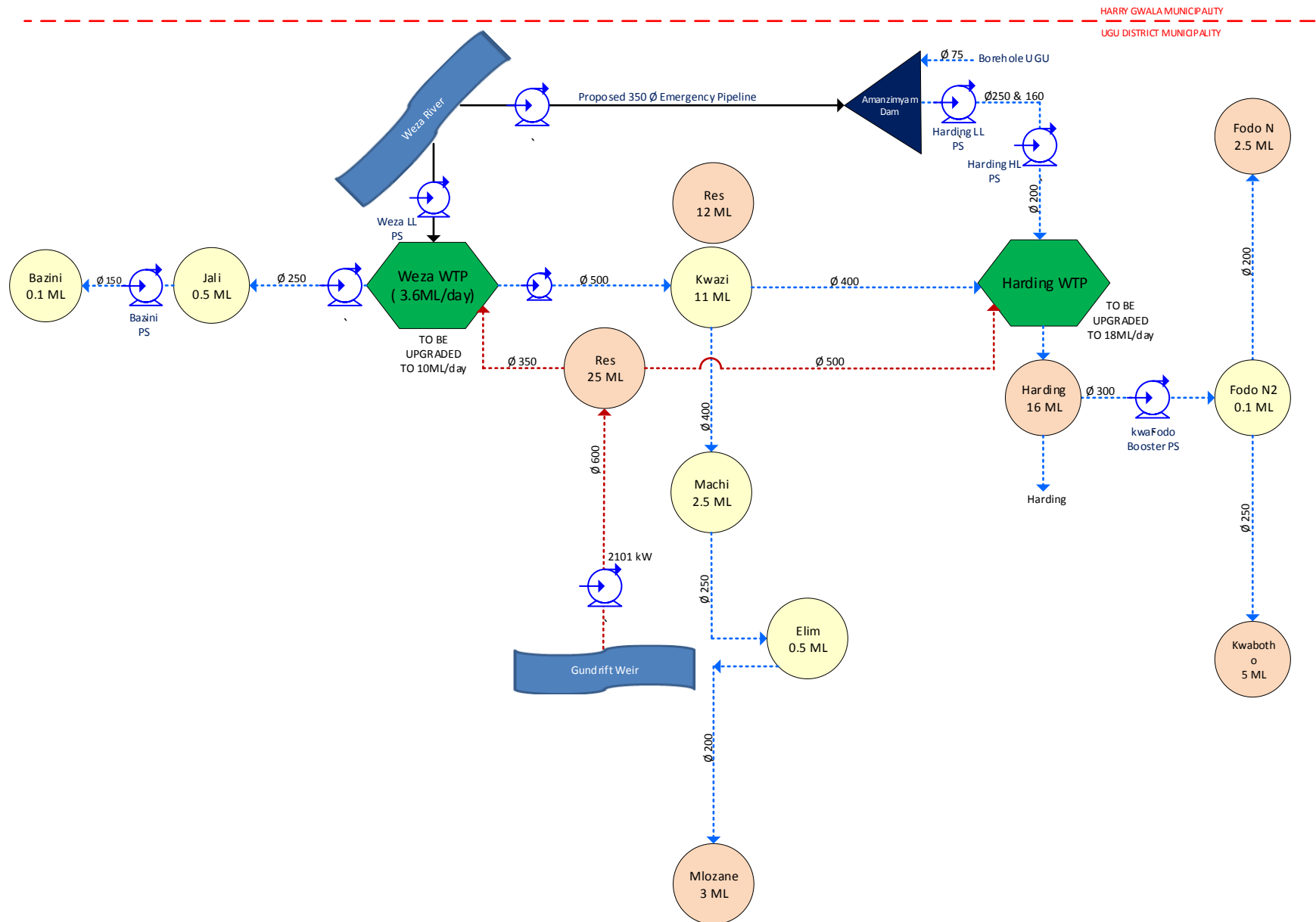
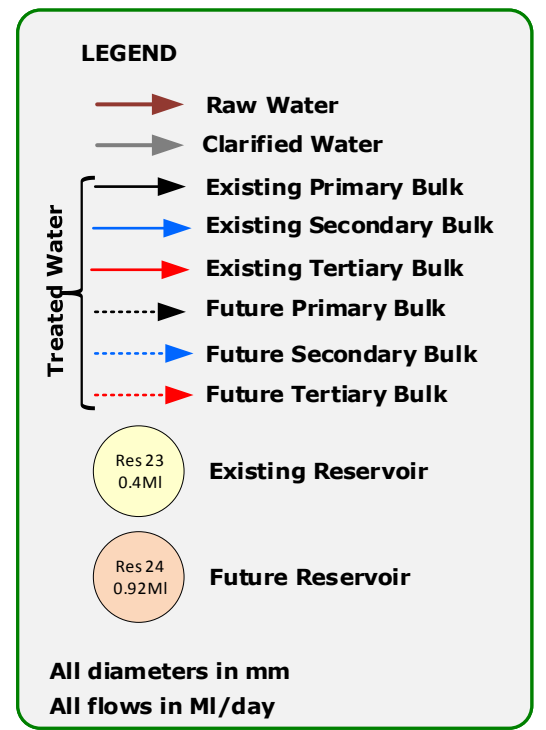

Figure 9-11
UG005 WSIA: HARDING-WEZA



9.6 UG006 WSIA: KwaFODO WATER SUPPLY SCHEME

9.6.1 Demand Model Intervention

9.6.1.1 Water Demand

The water demand for the KwaFodo Scheme was determined for 2020 and 2050 and included within **Table 9-11** below.

Table 9-10: Population and Water demand 2020 and 2050 for the KwaFodo Scheme

Population	Population 2020	Population 2050
		9368
Water Demand	Demand 2020	Demand 2050
		1.64

9.6.1.2 Water Resource Consideration

The KwaFodo Supply Scheme abstracts and treats water from the Cekeza River for the supply to the rural areas of KwaFodo. The yield of the current source is unknown. KwaFodo Water Supply scheme is also supplied by Harding/Weza Scheme through the Harding Reservoir (901m). The future plan is to decommission the existing abstraction point and WTP and incorporate the scheme into the Harding/Weza Scheme. The raw water augmentation options for the Harding WTP as discussed in Section 9.5 needs to be investigated and confirmed. Only then will the following upgrades be possible.

9.6.2 Water Supply Infrastructure

The following infrastructure will be required in order to adequately supply the KwaFodo Scheme and surrounding areas and is illustrated within **Figure 9-12** followed by the schematic layout of the WSIA within **Figure 9-13**.

9.6.2.1 Bulk conveyance and Storage

Potable water is pumped from Harding Command Reservoir (901m), via one stage pumping to the 0.5 Mℓ KwaFodo balancing Command Reservoir N2 (866 m) through a 300mm \varnothing bulk rising main. Water then be distributed to storage reservoirs via secondary and tertiary distribution mains (pipe sizes ranging from 75 mm \varnothing to 250 mm \varnothing) to supply the Gudlucingo, Mtintanyoni, Kamagwasu and Kuze areas .

9.6.2.2 Proposed interventions

- ✓ A 300mm \varnothing bulk main and pumpstation will be required to pump water from the Harding WTP to the proposed KwaFodo Reservoir N2;
- ✓ The existing KwaFodo Reservoir N should be upgraded to 2.5 Mℓ;
- ✓ The existing KwaFodo Reservoir 3 should be upgraded to 1 Mℓ;
- ✓ The existing KwaFodo Reservoir 4 should be upgraded to 0.9 Mℓ;

- ✓ The existing KwaFodo Reservoir 5 should be upgraded to 0.7 Mℓ;
- ✓ The existing KwaFodo Reservoir 6 should be upgraded to 0.5 Mℓ;
- ✓ The existing gravity main to KwaFodo Reservoir 3 should be upgraded to ø 150mm;
- ✓ The existing gravity main to KwaFodo Reservoir 4 should be upgraded to ø 100mm; and.
- ✓ The existing gravity main to KwaFodo Reservoir 5 should be upgraded to ø 90mm to cater for 2050 demand.

Design details of all the infrastructure components are provided within **Annexure B**.

9.6.3 Financial Requirements

The bulk cost requirement for kwaFodo Scheme is summarised within **Table 9-12** below.

Table 9-11: UG006 kwaFodo Scheme Cost Requirement

	Capital Cost	10% Contingencies	Total Cost (excl VAT)
Primary	R0.00	R0.00	R0.00
Secondary	R26 845 264.36	R2 684 526.44	R29 529 790.79
Tertiary	R3 201 297.91	R320 129.79	R3 521 427.70
Total	R30 046 562.26	R3 004 656.23	R33 051 218.49

The total bulk cost requirement for the KwaFodo Scheme is R33 051 218.49 (excl VAT). The scheme development cost per household is approximately R 8 800.

N

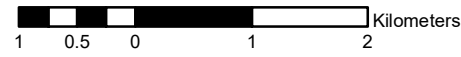

Legend

- Provincial Boundaries
- District Municipality Boundaries
- Local Municipality Boundaries
- Dams & Dam Names
- Rivers
- Settlements
- Major Towns

LOCALITY:

CLIENT:

MUNICIPALITY:

UGU DISTRICT MUNICIPALITY

CONSULTANTS

Project No.: 27814

Mariswe
PO Box 25549, Monument Park
Pretoria, 0105

Tel: +27 (0) 12 424 9700
Fax: +27 (0) 12 460 4071
Email: pretoria@uwp.co.za

PROJECT TITLE

Ugu DM: Universal Access Plan Phase III - Progressive Development of a Regional Concept Secondary Bulk Water Master Plan

MAP TITLE:

Total Bulk Water Supply Interventions - UG006: KwaFodo Harry Gwala District Municipality

DATE COMPLETED: January 2021

MAP NO.: DC 21 Figure 9-12

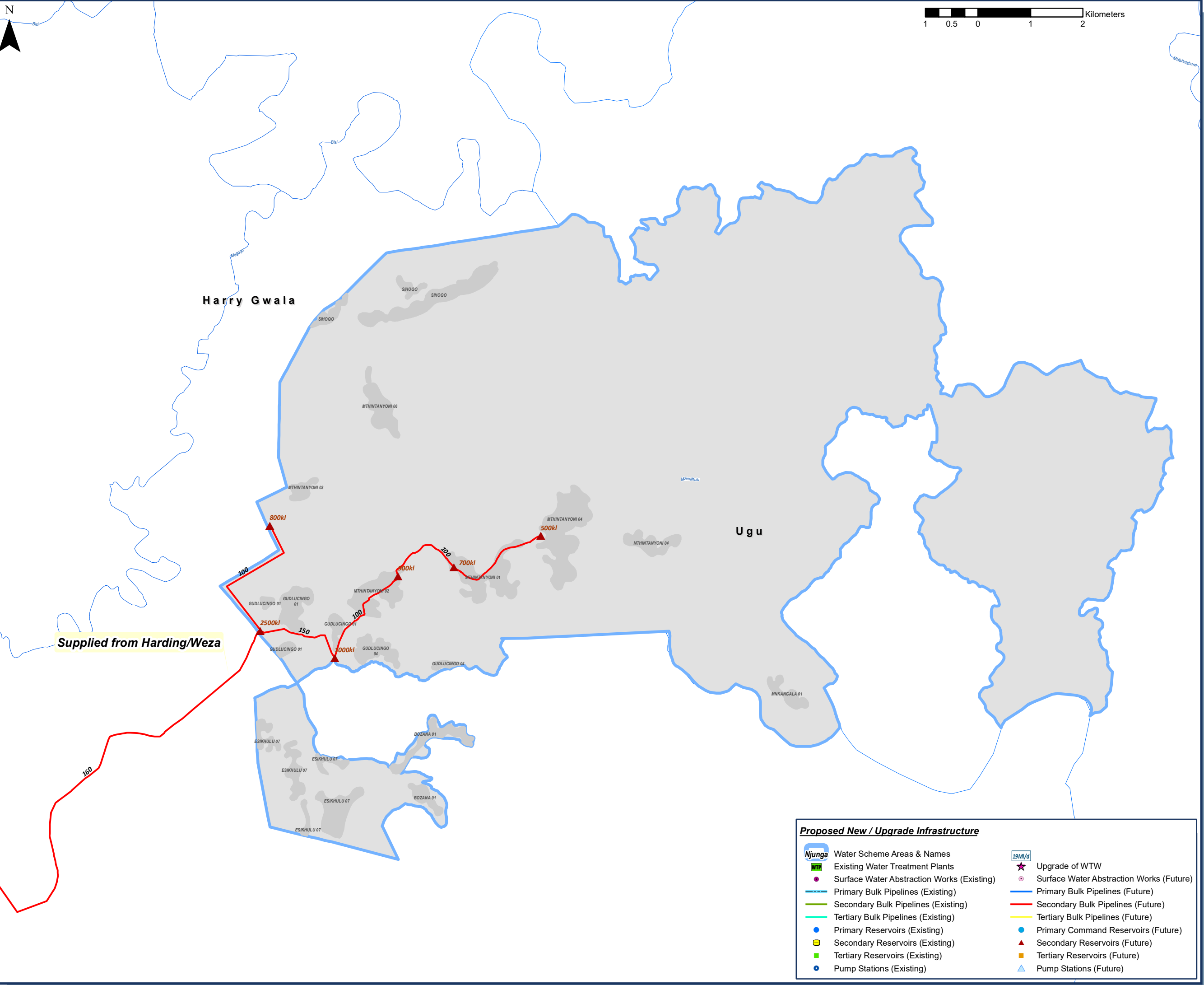

Proposed New / Upgrade Infrastructure

Water Scheme Areas & Names	Upgrade of WTW
Existing Water Treatment Plants	Surface Water Abstraction Works (Future)
Surface Water Abstraction Works (Existing)	Primary Bulk Pipelines (Future)
Primary Bulk Pipelines (Existing)	Secondary Bulk Pipelines (Future)
Secondary Bulk Pipelines (Existing)	Tertiary Bulk Pipelines (Future)
Tertiary Bulk Pipelines (Existing)	Primary Command Reservoirs (Future)
Primary Reservoirs (Existing)	Secondary Reservoirs (Future)
Secondary Reservoirs (Existing)	Tertiary Reservoirs (Future)
Tertiary Reservoirs (Existing)	Pump Stations (Future)
Pump Stations (Existing)	

Supplied from Harding/Weza

Harry Gwala

Ugu

Proposed New / Upgrade Infrastructure

- Water Scheme Areas & Names
- Existing Water Treatment Plants
- Surface Water Abstraction Works (Existing)
- Primary Bulk Pipelines (Existing)
- Secondary Bulk Pipelines (Existing)
- Tertiary Bulk Pipelines (Existing)
- Primary Reservoirs (Existing)
- Secondary Reservoirs (Existing)
- Tertiary Reservoirs (Existing)
- Pump Stations (Existing)
- Upgrade of WTW
- Surface Water Abstraction Works (Future)
- Primary Bulk Pipelines (Future)
- Secondary Bulk Pipelines (Future)
- Tertiary Bulk Pipelines (Future)
- Primary Command Reservoirs (Future)
- Secondary Reservoirs (Future)
- Tertiary Reservoirs (Future)
- Pump Stations (Future)

Figure 9-13
UG006 WSIA: KwaFodo

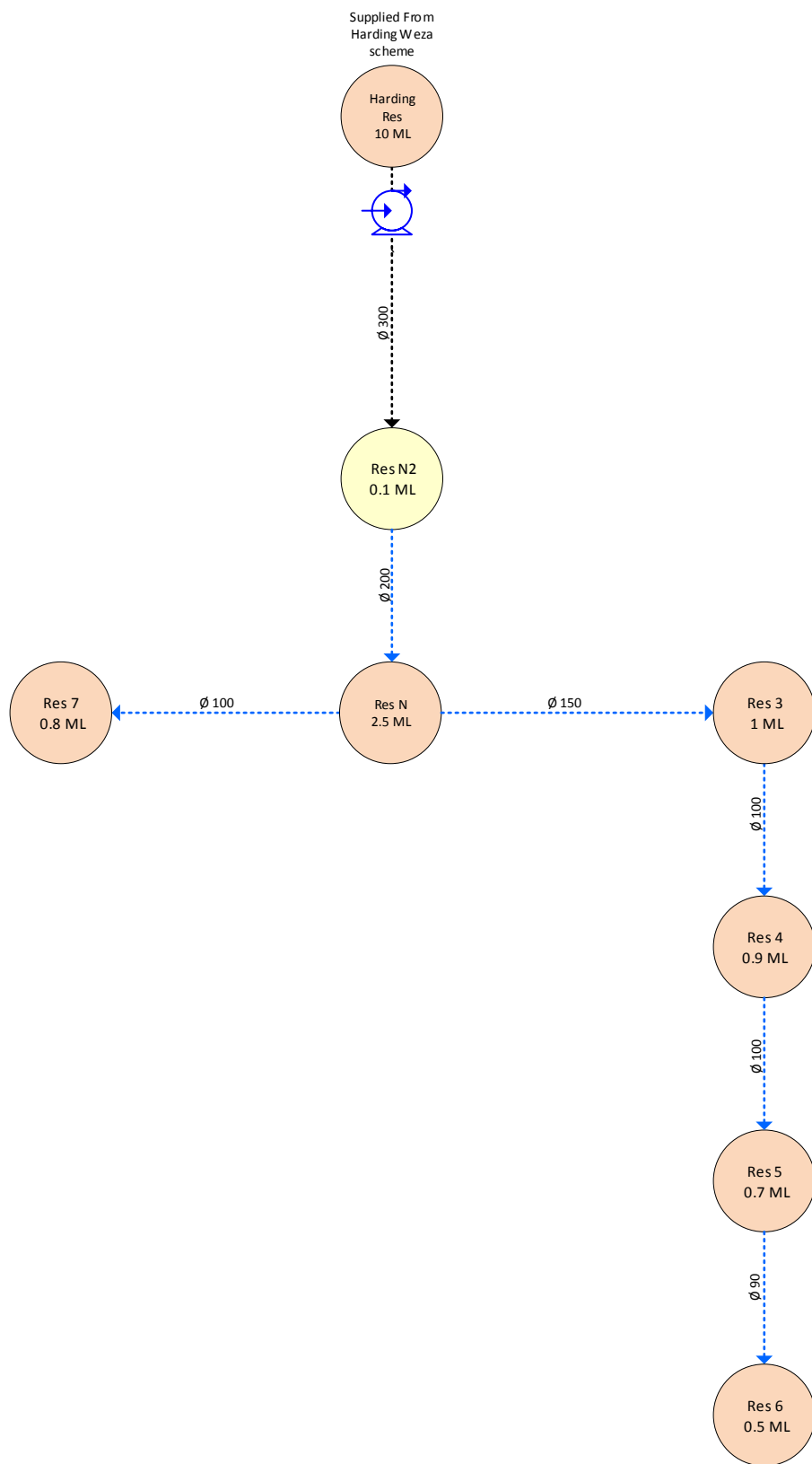

LEGEND

- Raw Water
- Clarified Water
- Existing Primary Bulk
- Existing Secondary Bulk
- Existing Tertiary Bulk
- Future Primary Bulk
- Future Secondary Bulk
- Future Tertiary Bulk

Treated Water

- Existing Reservoir (Res 23 0.4 ML)
- Future Reservoir (Res 24 0.92 ML)

All diameters in mm
 All flows in ML/day

9.7 UG007 WSIA: KWALEMBE WATER SUPPLY SCHEME

9.7.1 Demand Model Intervention

9.7.1.1 Water Demand

The water demand for the KwaLembe Scheme was determined for 2020 and 2050 and included within **Table 9-13** below.

Table 9-12: Population and Water demand 2020 and 2050 for the Kwalemba Scheme

Population	Population 2020	Population 2050
		16 813
Water Demand	Demand 2020	Demand 2050
		2.93

9.7.1.2 Water Resource Consideration

The kwaLembe WTP abstracts water from the uMkhomazi River. At the point of abstraction, the yield of the uMkhomazi River is estimated to be 16.85 Mm³/a or 46Mℓ/day. The kwaLembe WTP has a capacity of 1.4Mℓ/day and is planned to be upgraded to 6Mℓ/day. This will be sufficient for the 2050 water demand.

9.7.2 Water Supply Infrastructure

The following infrastructure will be required to adequately supply the Kwalemba Scheme and surrounding areas and is illustrated within **Figure 9-14** followed by the schematic layout of the WSIA within **Figure 9-15**.

9.7.2.1 Bulk conveyance and Storage

Raw water is pumped, via one stage pumping, from the uMkhomazi River to the Kwalemba WTP. Potable water is pumped from the WTP (187m), via one stage pumping to the 5 Mℓ Kwalemba Command Reservoir (396 m) through a ø 250mm bulk rising main. From Kwalemba Command, water is pumped through ø 250mm pipeline to Kwalemba Reservoir one(706m).

Kwalemba Reservoir 1 supplies water to Kwalemba Reservoir 2 (884m) through a ø75 mm rising main. Kwalemba Reservoir 1 also distributes water to storage reservoirs via secondary and tertiary distribution mains (pipe sizes ranging from 75 mm ø to 250 mm ø) to supply the Emandlalathi, Mtoli, Mkhumbani, Odidi, Okhalweni, Mphambanyoni and areas.

9.7.2.2 Proposed interventions

- ✓ The existing abstraction works at the uMkhomazi River WTP only needs to be upgraded to 5 Mℓ/day;
- ✓ The uLembe WTP will need to be upgraded to 5 Mℓ/day;
- ✓ The Existing Kwalemba Command Reservoir will need to be upgraded to 5 Mℓ/day;
- ✓ The existing KwaLembe Reservoir one will need to be upgraded to 4 .5Mℓ/day;
- ✓ The existing KwaLembe Reservoir two will need to be upgraded to 0.4 Mℓ/day;

- ✓ The existing KwaLembe Reservoir three will need to be upgraded to 1.6Mℓ/day;
- ✓ The existing KwaLembe Reservoir four will need to be upgraded to 0.6 Mℓ/day;
- ✓ The existing pipeline to KwaLembe Command Reservoir will need to be upgraded to ø 250 mm pipeline;
- ✓ The existing pipeline to KwaLembe Reservoir One will need to be upgraded to ø 250 mm pipeline;
- ✓ The existing pipeline to KwaLembe Reservoir Two will need to be upgraded to ø 75 mm pipeline;
- ✓ The existing pipeline to KwaLembe Reservoir Three will need to be upgraded to ø 150 mm pipeline;
- and
- ✓ The existing pipeline to KwaLembe Reservoir Four will need to be upgraded to ø 90 mm pipeline to meet the 2050 demand

Design details of all the infrastructure components are provided within **Annexure B**.

9.7.3 Financial Requirements

The bulk cost requirement for kwaLembe Scheme is summarised within **Table 9-14** below.









Table 9-13: UG007 kwaLembe Scheme Cost Requirement

	Capital Cost	10% Contingencies	Total Cost (excl VAT)
Primary	R18 483 000.00	R1 848 300.00	R20 331 300.00
Secondary	R74 338 542.28	R7 433 854.23	R81 772 396.50
Tertiary	R17 194 560.77	R1 719 456.08	R18 914 016.84
Total	R110 016 103.04	R11 001 610.30	R121 017 713.35

The total bulk cost requirement for the KwaLembe Scheme is R121 017 713.35 (excl VAT). The scheme development cost per household is approximately R 18 000.



Legend

-  Provincial Boundaries
-  District Municipality Boundaries
-  Local Municipality Boundaries
-  National Roads
-  Main Roads
-  Dams & Dam Names
-  Rivers
-  Settlements
-  Major Towns

LOCALITY:

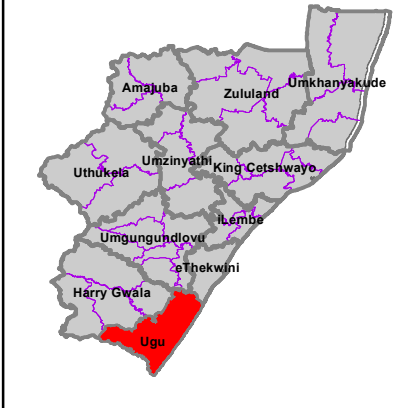

CLIENT:



MUNICIPALITY:



CONSULTANTS

Project No.: 27814



Mariswe
PO Box 25549, Monument Park
Pretoria, 0105

Tel: +27 (0) 12 424 9700
Fax: +27 (0) 12 460 4071
Email: pretoria@uwp.co.za

PROJECT TITLE

**Ugu DM: Universal
Access Plan Phase III -
Progressive Development of a
Regional Concept Secondary
Bulk Water Master Plan**

MAP TITLE:

**Total Bulk Water Supply
Interventions -
UG007: KwaLembe
Ugu District Municipality**









DATE COMPLETED:

January 2021

MAP NO.:

DC 21 Figure 9-14

Proposed New / Upgrade Infrastructure

- | | | |
|--|--|---|
|  Water Scheme Areas & Names |  Existing Water Treatment Plants |  Upgrade of WTW |
|  Surface Water Abstraction Works (Existing) |  Surface Water Abstraction Works (Future) |  Primary Bulk Pipelines (Future) |
|  Primary Bulk Pipelines (Existing) |  Secondary Bulk Pipelines (Future) | |
|  Secondary Bulk Pipelines (Existing) | Tertiary Bulk Pipelines (Future) | |
| Tertiary Bulk Pipelines (Existing) | Primary Command Reservoirs (Future) | |
| Primary Reservoirs (Existing) | Secondary Reservoirs (Future) | |
| Secondary Reservoirs (Existing) | Tertiary Reservoirs (Future) | |
| Tertiary Reservoirs (Existing) | | |

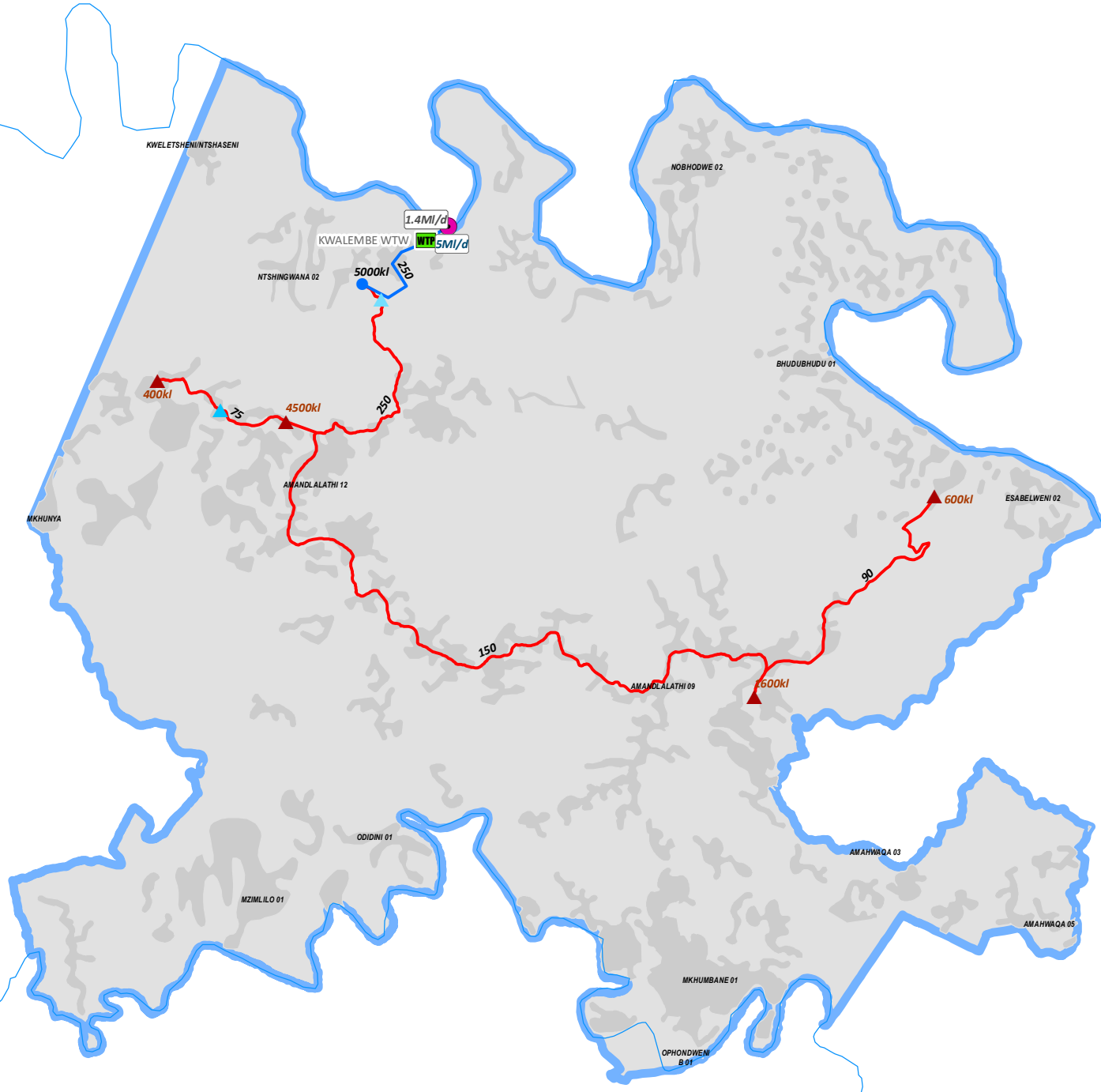
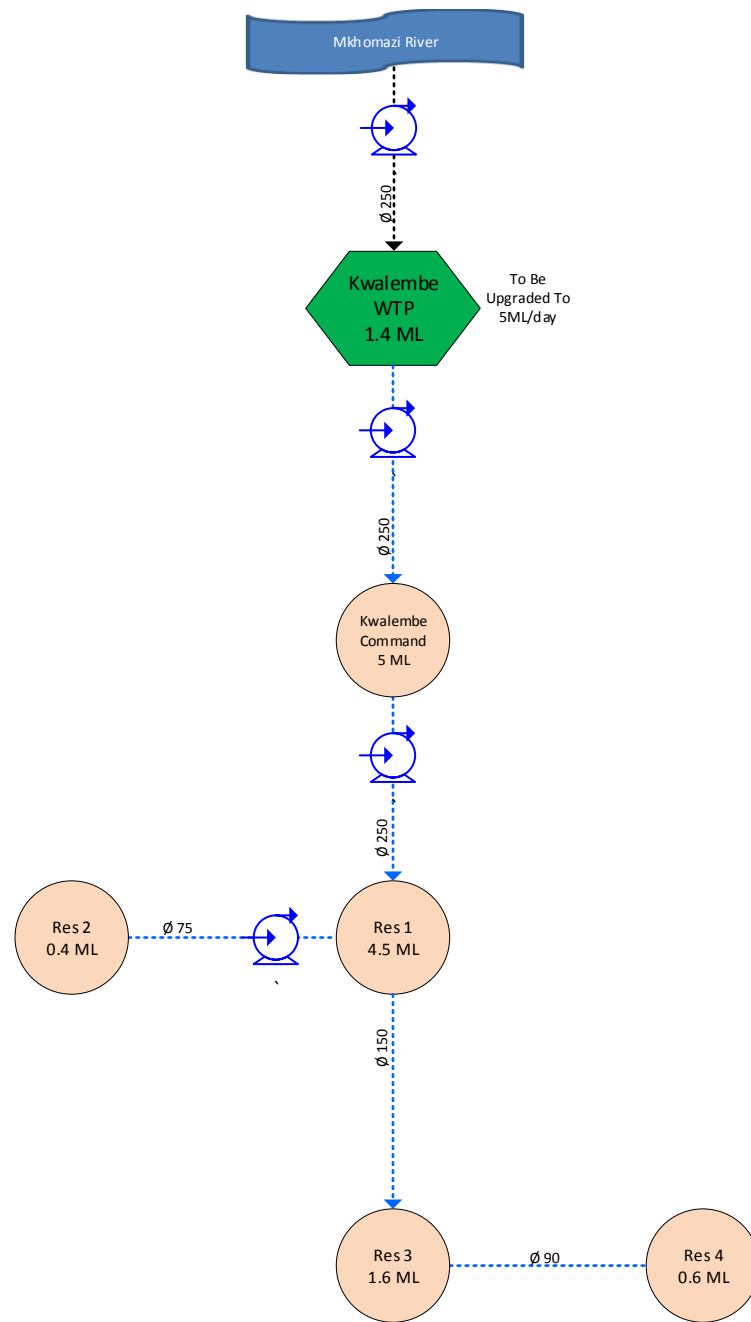

Figure 9-15
UG007 WSIA: Kwalembe



LEGEND

- Raw Water
- Clarified Water
- Existing Primary Bulk
- Existing Secondary Bulk
- Existing Tertiary Bulk
- Future Primary Bulk
- Future Secondary Bulk
- Future Tertiary Bulk

Treated Water

- Existing Reservoir (Res 23, 0.4 ML)
- Future Reservoir (Res 24, 0.92 ML)

All diameters in mm
All flows in ML/day

9.8 UG008 WSIA: PHUNGASHE/MHLABATSHANE WATER SUPPLY SCHEME

9.8.1 Demand Model Intervention

9.8.1.1 Water Demand

The water demand for the Phungashe/Mhlabatshane WSIA was determined for 2020 and 2050 and included within **Table 9-15**.

Table 9-14: Population and Water demand 2020 and 2050 for the Phungashe/Mahlabatshane WSIA

Population	Population 2020	Population 2050
		64 641
Water Demand	Demand 2020 (Mℓ/day)	Demand 2050 (Mℓ/day)
	10.95	18.32

9.8.1.2 Water Resource Consideration

The Phungashe/Mhlabatshane Scheme is supplied from the Mhlabatshane Dam that has a yield of 1.6 Mm³/annum (4.4 Mℓ/day). The augmentation of the raw water supply to the scheme by 4Mℓ/day from uMzimkhulu River, is currently in design stage. The current resource intervention will not be adequate to meet the 2050 demand.

The proposed Ncwabeni Dam is a possible raw water source to augment the supply to the Phungashe/Mahlabatshane scheme.

The proposed New Biggen Dam is also another option to augment the Phungashe/Mhlabatshane Scheme

It is recommended that:

- ✓ A detailed hydrological study be undertaken to determine whether the yield at the proposed abstraction point on the Mzimkhulu River would be able to supply the 2050 demand for the scheme; and
- ✓ The detailed feasibility of the proposed New Biggen Dam be reviewed as detailed in Section 9.5.

Only then will the interventions detailed in section 9.8.2 be possible.

9.8.2 Water Supply Infrastructure

The following infrastructure upgrades and augmentation will be required in order to adequately supply the Phungashe-Mhlabatshane WSIA and is illustrated within **Figure 9-16** followed by the schematic layout of the WSIA within **Figure 9-17**.

9.8.2.1 Bulk Conveyance and Storage

- ✓ The Mhlabatshane WTP supplies Ndwebu reservoir via a 160mmØ pipeline. The Ndwebu reservoir capacity is 0.6Mℓ;
- ✓ The Mhlabatshane WTP supplies water to an existing balancing tank via 160mmØ pipeline;
- ✓ The balancing tank supplies water to the Phungashe Res via a 160mmØ pipeline. The Phungashe reservoir has a capacity of 0.5Mℓ. From the Phungashe reservoir, there is an offtake to Res 1 via 160mmØ pipeline. Res 1 has a capacity of 2Mℓ;
- ✓ Res 1 then supplies Phungashe Village reservoir via 400mmØ pipeline. The Phungashe Village reservoir has a capacity of 0.6Mℓ;
- ✓ The Phungashe Village supplies Nomagetje reservoir via a 400mmØ pipeline. The Nomagetje reservoir has a capacity of 0.25Mℓ. The Nomagetje reservoir supplies KwaPhongolo reservoir via a 400mmØ pipeline. The KwaPhongolo reservoir has two (2) storage reservoirs totalling 1.9Mℓ;
- ✓ From the Phongolo reservoir, there is an offtake to KwaNcengesi reservoir via pipelines ranging from 450mmØ to 350mmØ;
- ✓ The KwaNcengesi reservoir supplies the St Faith reservoir via a 430mmØ pipeline. The St Faiths reservoir has a capacity of 2.5Mℓ. The St Faith reservoir then supplies Mehloinyama reservoir via a 430mmØ pipeline. The Mehloinyama has two (2) reservoir storage which total 0.75Mℓ.
- ✓ The Mehloinyama reservoir supplies Qwabe and Enkulu reservoir. The Qwabe reservoir capacity is unknown but the Enkulu reservoir has a capacity of 0.5Mℓ; and
- ✓ The Enkulu reservoir supplies the Frank Lands reservoir via a 160mmØ pipeline. The Frank land reservoir has a capacity of 1Mℓ.

All of the above infrastructure have sufficient capacity to supply the 2050 water demands and no upgrades are necessary.

9.8.2.2 Proposed Interventions

- ✓ Construction of a 450mm Ø pipeline from the proposed Mhlabatshane Terminal Reservoir on the proposed New Biggen Regional Scheme to the balancing tank at the Mhlabatshane WTP;
- ✓ The existing 160mm Ø rising main from the WTP to the Kwaphungashe command must be upgraded to a 400mm Ø;
- ✓ The pipeline from the uMzimkhulu River abstraction to the Mhlabatshane WTP needs to be upgraded to 500mm Ø;

9.8.3 Financial Requirements

The bulk cost requirement for Phungashe/Mhlabatshane WSIA is summarised within **Table 9-16**.

Table 9-15: UG008 Phungashe/Mhlabatshane Scheme Cost Requirement

	Capital Cost	10% Contingencies	Total Cost (Excl VAT)
Primary	R0.00	R0.00	R0.00
Secondary	R78 947 429.82	R7 894 742.98	R86 842 172.80
Tertiary	R28 551 674.82	R2 855 167.48	R31 406 842.30
Total	R107 499 104.63	R10 749 910.46	R118 249 015.10

The total bulk cost requirement for the Phungashe/Mhlabatshane Scheme is R118 249 015.10 (excl VAT).
The scheme development cost per household is approximately R 4 500.



Supply from New Biggen Regional Scheme

Proposed New / Upgrade Infrastructure

Water Scheme Areas & Names	Upgrade of WTW
Existing Water Treatment Plants	Surface Water Abstraction Works (Future)
Surface Water Abstraction Works (Existing)	Primary Bulk Pipelines (Future)
Primary Bulk Pipelines (Existing)	Secondary Bulk Pipelines (Future)
Secondary Bulk Pipelines (Existing)	Tertiary Bulk Pipelines (Future)
Tertiary Bulk Pipelines (Existing)	Primary Command Reservoirs (Future)
Primary Reservoirs (Existing)	Secondary Reservoirs (Future)
Secondary Reservoirs (Existing)	Tertiary Reservoirs (Future)
Tertiary Reservoirs (Existing)	

Legend

Provincial Boundaries	
District Municipality Boundaries	
Local Municipality Boundaries	
National Roads	
Main Roads	
Dams & Dam Names	
Rivers	
Settlements	
Major Towns	

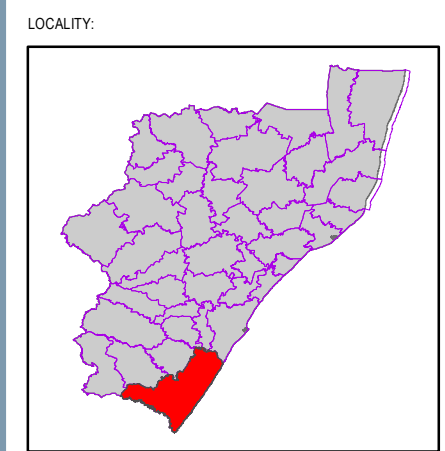

CLIENT:

MUNICIPALITY:

UGU DISTRICT MUNICIPALITY

CONSULTANTS

Project No.: 27814

Mariswe
PO Box 25549, Monument Park
Pretoria, 0105

Tel: +27 (0) 12 424 9700
Fax: +27 (0) 12 460 4071
Email: pretoria@uwp.co.za

PROJECT TITLE

UGU DM: Universal Access Plan Phase III - Progressive Development of a Regional Concept Secondary Bulk Water Master Plan

MAP TITLE:

Total Bulk Water Supply Interventions - UG008: Pungashe/Mhlabashane UGU District Municipality

DATE COMPLETED:

January 2021

MAP NO.:

DC 21 Figure 8-16

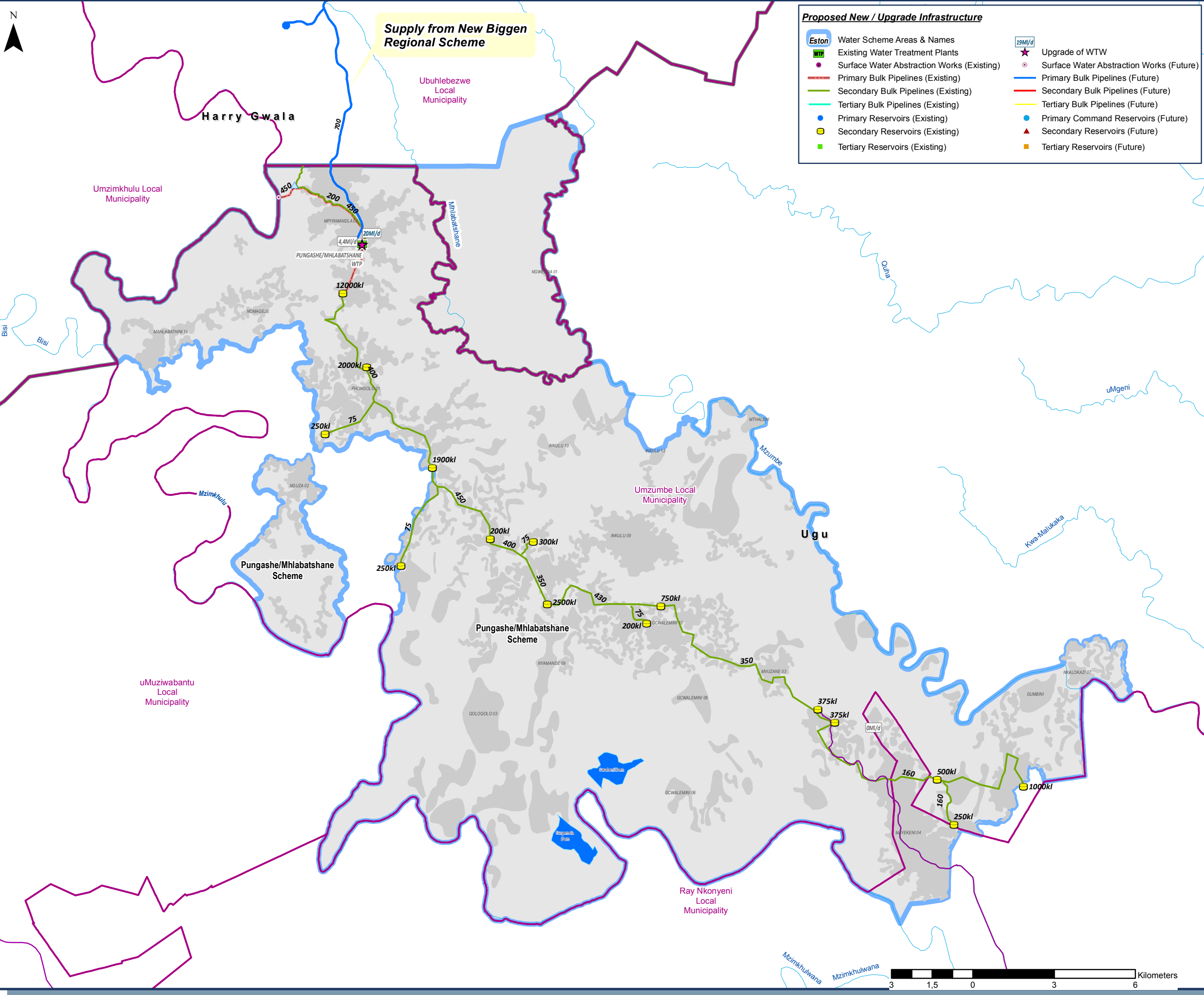
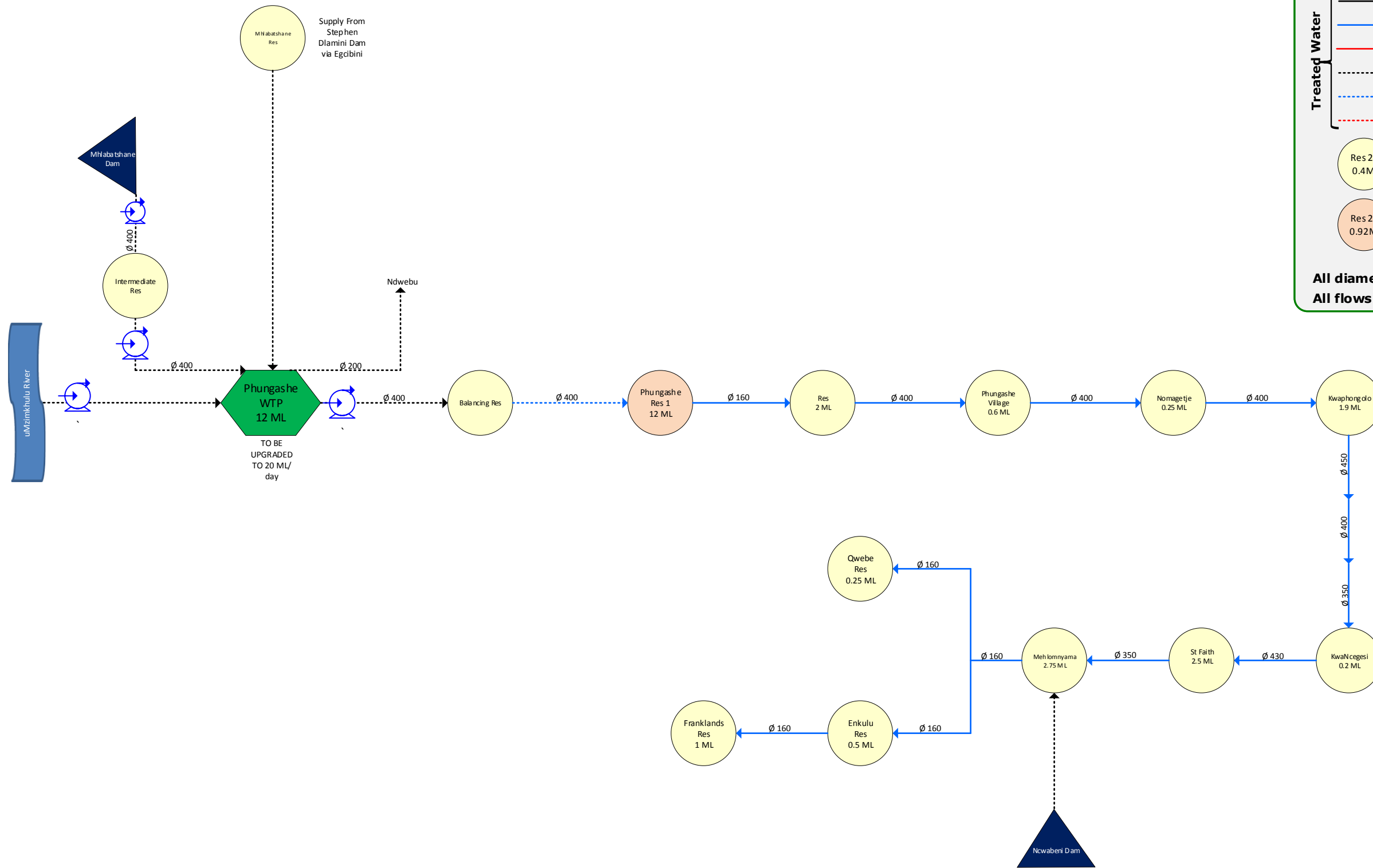

Figure 9-17
UG008 WSIA: Phungashe/Mhlabatshane Scheme



LEGEND

- Raw Water
- Clarified Water
- Treated Water**
 - Existing Primary Bulk
 - Existing Secondary Bulk
 - Existing Tertiary Bulk
 - Future Primary Bulk
 - Future Secondary Bulk
 - Future Tertiary Bulk
- Existing Reservoir
- Future Reservoir

All diameters in mm
All flows in ML/day

9.9 UG009 WSIA: KWAHLONGWA WATER SUPPLY SCHEME

9.9.1 Demand Model Intervention

9.9.1.1 Water Demand

The water demand for the KwaHlongwa Scheme was determined for 2020 and 2050 and included within **Table 9-17** below.

Table 9-16: Population and Water demand 2020 and 2050 for the KwaHlongwa Scheme

Population	Population 2020	Population 2050
	6 953	11 169
Water Demand	Demand 2020	Demand 2050
	1.20	2.01

9.9.1.2 Water Resource Consideration

The KwaHlongwa Scheme abstracts, treats, and distributes water from the KwaMalukaka River for the supply to the rural areas of KwaHlongwa. The future plan is to decommission the existing abstraction and WTP and incorporate it into the KwaNdelu Scheme that abstracts water from the Umzumbe River. Water resource considerations for this area are covered in the KwaNdelu WSS section.

9.9.2 Water Supply Infrastructure

9.9.2.1 Bulk conveyance and Storage

- ✓ Potable water will gravitate from the KwaNdelu Reservoir (726m), to the 2 Mℓ KwaHlongwa Command Reservoir (363 m).; and
- ✓ KwaHlongwa Command Reservoir will distribute water to storage reservoirs via secondary and tertiary distribution mains (pipe sizes ranging from 75 mm ø to 250 mm ø) to supply the Dibi, Umgubo, lwuku, Nkalokazi, Gqayinyanga, Velumemeze and Nkehlamandla areas.

9.9.2.2 Proposed interventions

The following infrastructure will be required to adequately supply the KwaHlongwa Scheme and surrounding areas and is illustrated within **Figure 9-18** followed by the schematic layout of the WSIA within **Figure 9-19**.

- ✓ The Existing KwaHlongwa Command Reservoir will need to be upgraded to 2 Mℓ/day;
- ✓ The existing KwaHlongwa Reservoir one will need to be upgraded to 0.2Mℓ/day;
- ✓ The existing KwaHlongwa Reservoir two will need to be upgraded to 0.9 Mℓ/day;
- ✓ The existing KwaHlongwa Reservoir three will need to be upgraded to 0.1Mℓ/day;
- ✓ The existing KwaHlongwa Reservoir four will need to be upgraded to 0.2 Mℓ/day;
- ✓ The existing KwaHlongwa Reservoir five will need to be upgraded to 0.2 Mℓ/;
- ✓ The existing KwaHlongwa Reservoir six will need to be upgraded to 0.5 Mℓ/day;

- ✓ The existing pipeline to KwaHlongwa Reservoir two will need to be upgraded to ø 150 mm pipeline;
- ✓ Offtake to KwaHlongwa Reservoir one will need to be upgraded to ø 75 mm pipeline;
- ✓ Offtake to KwaHlongwa Reservoir three will need to be upgraded to ø 75 mm pipeline;
- ✓ Offtake to KwaHlongwa Reservoir four will need to be upgraded to ø 75mm;
- ✓ Offtake to KwaHlongwa Reservoir five will need to be upgraded to ø 75 mm pipeline; and
- ✓ The existing pipeline to KwaHlongwa Reservoir six will need to be upgraded to ø 110 mm pipeline to meet 2050 demand.

Design details of all the infrastructure components are provided within **Annexure B**.

9.9.3 Financial Requirements

The bulk cost requirement for KwaHlongwa WSIA is summarised within **Table 9-18** below.







Table 9-17: UG009 KwaHlongwa Scheme Cost Requirement

	Capital Cost	10% Contingencies	Total Cost (excl VAT)
Primary	R0.00	R0.00	R0.00
Secondary	R29 328 863.99	R2 932 886.40	R32 261 750.39
Tertiary	R4 597 878.01	R459 787.80	R5 057 665.81
Total	R33 926 742.00	R3 392 674.20	R37 319 416.19

The total bulk cost requirement for the KwaHlongwa Scheme is R37 319 416.19 (excl VAT). The scheme development cost per household is approximately R 13 400.



Legend

-  Provincial Boundaries
-  District Municipality Boundaries
-  Local Municipality Boundaries
-  Dams & Dam Names
-  Rivers
-  Settlements
-  Major Towns

LOCALITY:

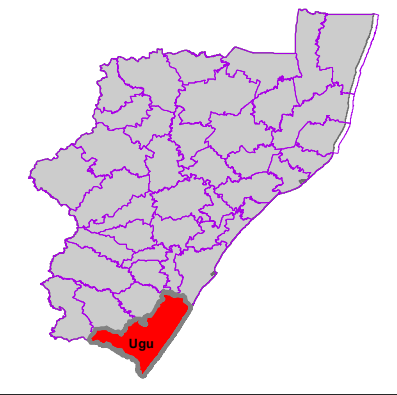

CLIENT:



MUNICIPALITY:



UGU DISTRICT MUNICIPALITY

CONSULTANTS



MARISWE



JTN

Project No.: 27814

Mariswe
PO Box 25549, Monument Park
Pretoria, 0105

Tel: +27 (0) 12 424 9700
Fax: +27 (0) 12 460 4071
Email: pretoria@uwp.co.za

PROJECT TITLE

**Ugu DM: Universal
Access Plan Phase III -
Progressive Development of a
Regional Concept Secondary
Bulk Water Master Plan**

MAP TITLE:

**Total Bulk Water Supply
Interventions -
UG09: KwaHlongwa
Ugu District Municipality**

DATE COMPLETED: January 2021

MAP NO.: DC 21 Figure 9-18

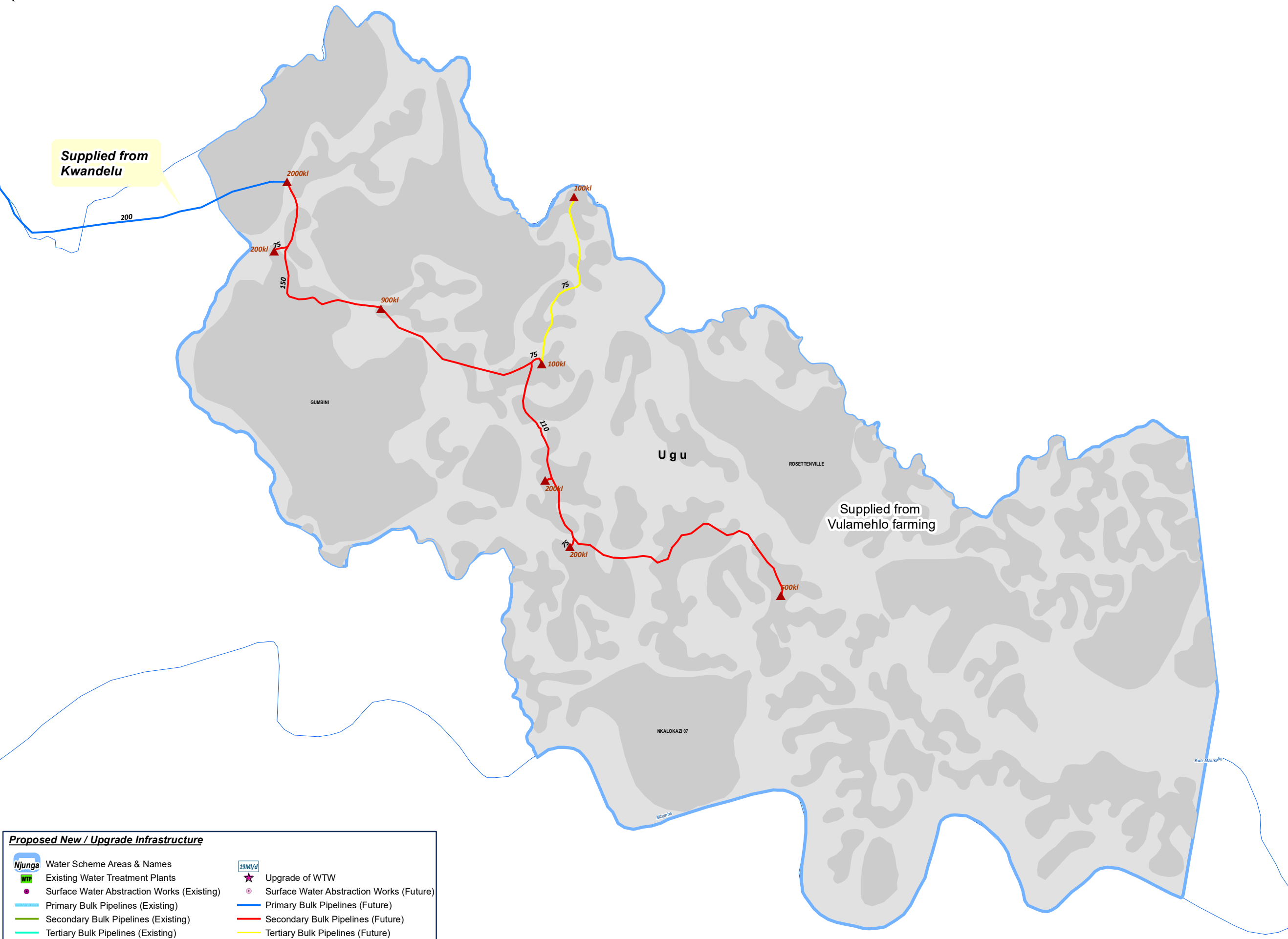

Proposed New / Upgrade Infrastructure



















<p>Njunga Water Scheme Areas & Names</p> <ul style="list-style-type: none">  Existing Water Treatment Plants  Surface Water Abstraction Works (Existing)  Primary Bulk Pipelines (Existing)  Secondary Bulk Pipelines (Existing)  Tertiary Bulk Pipelines (Existing)  Primary Reservoirs (Existing)  Secondary Reservoirs (Existing)  Tertiary Reservoirs (Existing)  Pump Stations (Existing) 	<p>19M/d</p> <ul style="list-style-type: none">  Upgrade of WTW  Surface Water Abstraction Works (Future)  Primary Bulk Pipelines (Future)  Secondary Bulk Pipelines (Future)  Tertiary Bulk Pipelines (Future)  Primary Command Reservoirs (Future)  Secondary Reservoirs (Future)  Tertiary Reservoirs (Future)  Pump Stations (Future)
--	--

Figure 9-19
UG009 WSIA: Kwahlongwa



LEGEND

- Raw Water
- Clarified Water
- Treated Water**
 - Existing Primary Bulk
 - Existing Secondary Bulk
 - Existing Tertiary Bulk
 - Future Primary Bulk
 - Future Secondary Bulk
 - Future Tertiary Bulk
- Res 23 (0.4 ML) Existing Reservoir
- Res 24 (0.92 ML) Future Reservoir

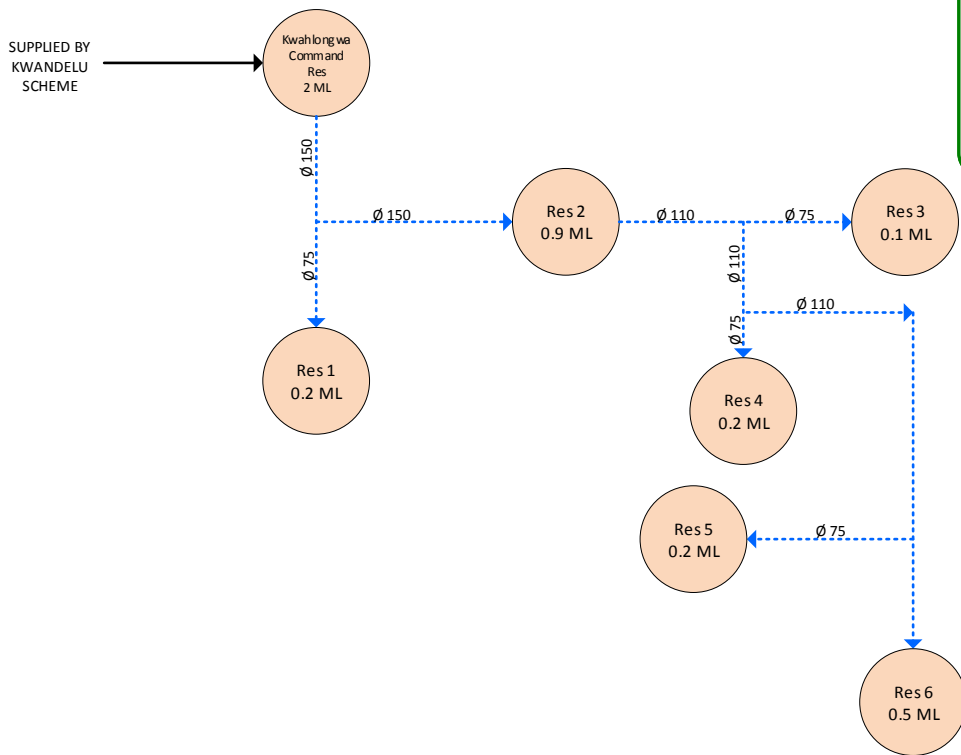
All diameters in mm
All flows in ML/day

9.10 UG010 WSIA: VULAMEHLO FARMING SCHEME

9.10.1 Demand Model Intervention

9.10.1.1 Water Demand

The water demand for the Vulamehlo Farming WSIA was determined for 2020 and 2050 and included within **Table 9-19**.

Table 9-18: Population and Water demand 2020 and 2050 for the Vulamehlo Farming WSIA

Population	Population 2020	Population 2050
		12 592
Water Demand	Demand 2020 (Mℓ/day)	Demand 2050 (Mℓ/day)
		3.75

9.10.1.2 Water Resource Consideration

The Vulamehlo Farming Scheme area is supplied from a variety of sources that are as follows:

- ✓ Privately installed boreholes;
- ✓ KwaNdelu Water Supply Scheme; and
- ✓ uMzinto Scheme.

The future plan is to use a combination of the Kwandelu and Umzinto Schemes to supply the Vulamehlo Farming Area. The existing water resources however need to be confirmed. A hydrological investigation is therefore required on the uMtwalume River to determine if an impoundment is required to improve the yield to supply the 2050 demand of the Kwandelu and Vulamehlo Farming Schemes.

Only then will the interventions detailed in section 9.10.2 be possible.

9.10.2 Water Supply Infrastructure

Infrastructure upgrades and augmentation will be required in order to adequately supply the Vulamehlo Farming WSIA and is illustrated within **Figure 9-20** followed by the schematic layout of the WSIA within **Figure 9-21**.

9.10.2.1 Bulk Conveyance and Storage

- ✓ The existing pipeline from Qwabe reservoir to Gumante, Kwa-Nkosi and Nkwazi reservoirs is a 63mm;
- ✓ The other section of the Vulamehlo Farming scheme is supplied via a 75mmØ pipeline from the KwaHlaba pipeline; and
- ✓ Most of the existing reservoirs under this scheme are positioned in areas that are lower than the households. The supply network and reservoirs have been re-configured to allow better functioning of the scheme.

9.10.2.2 Proposed Interventions

The following interventions will be required for the scheme to meet the 2050 demand for storage and conveyance:

- ✓ A proposed 0.7Mℓ Sukyvane/Nyonyana reservoir supplied via a 160mmØ pipeline from the Qwabe reservoir;
- ✓ Upgrade the existing pipeline from Sukyvane to the proposed 0.65Mℓ Cabhane Reservoir to a 110mmØ;
- ✓ Provide a tee off the Sukyvane-Cabhane pipeline to supply the proposed 0.4Mℓ Florida/Msinsini Reservoir via a 110mmØ pipeline;
- ✓ Provide a tee off the Sukyvane-Cabhane pipeline to supply the proposed 0.35Mℓ Vulamehlo Farming Reservoir 1 via a 75mmØ pipeline;
- ✓ Upgrade the existing 75mmØ pipeline from KwaHlaba Reservoir to the proposed 0.2Mℓ Khwezi Reservoir to 110mmØ; and
- ✓ Construct a 75mmØ pipeline from Khwezi Reservoir to the proposed 0.25Mℓ Ntengoland.

9.10.3 Financial Requirements

The bulk cost requirement for Vulamehlo Farming WSIA is summarised within **Table 9-20** below.

Table 9-19: UG010 Vulamehlo Farming Scheme Cost Requirement

	Capital Cost	10% Contingencies	Total Cost (Excl VAT)
Primary	R0.00	R0.00	R0.00
Secondary	R26 579 465.75	R2 657 946.58	R29 237 412.33
Tertiary	R10 077 160.05	R1 007 716.01	R11 084 876.06
Total	R36 656 625.81	R3 665 662.58	R40 322 288.39

The total bulk cost requirement for the Vulamehlo Farming Scheme is R40 322 288.39 (excl VAT). The scheme development cost per household is approximately R 4 600.

Layout

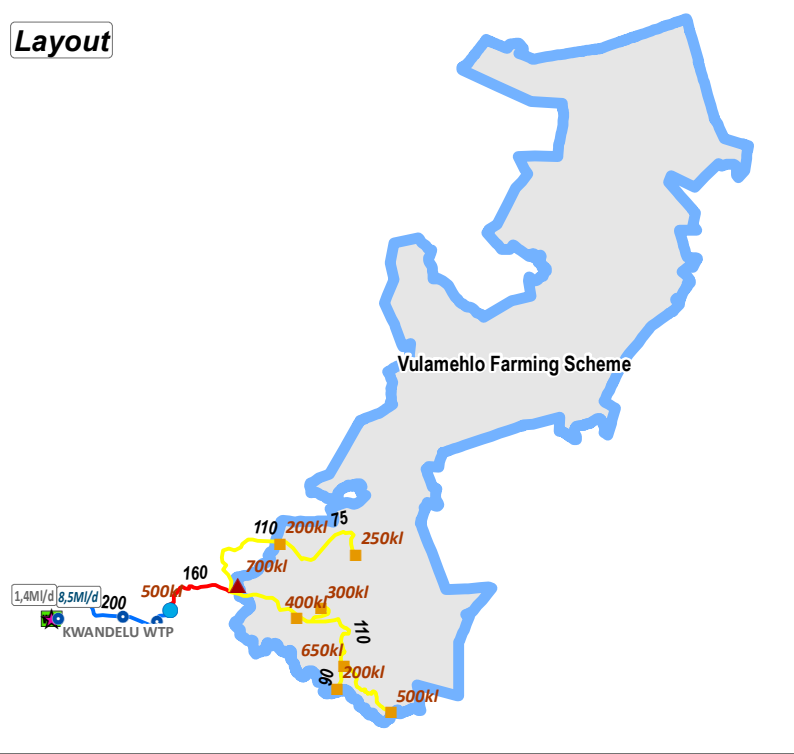

Legend

- Provincial Boundaries
- District Municipality Boundaries
- Local Municipality Boundaries
- National Roads
- Main Roads
- Dams & Dam Names
- Rivers
- Settlements
- Major Towns

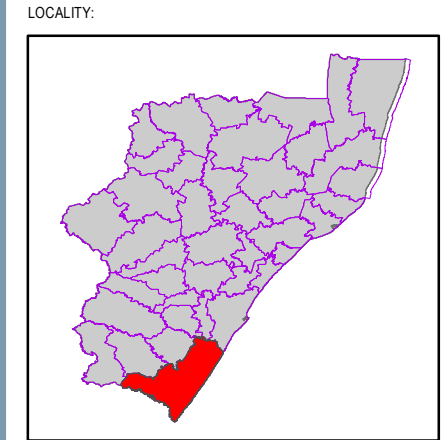

CLIENT:

MUNICIPALITY:

UGU DISTRICT MUNICIPALITY

CONSULTANTS

Project No.: 27814

Mariswe
PO Box 25549, Monument Park
Pretoria, 0105

Tel: +27 (0) 12 424 9700
Fax: +27 (0) 12 460 4071
Email: pretoria@uwp.co.za

PROJECT TITLE

UGU DM: Universal Access Plan Phase III - Progressive Development of a Regional Concept Secondary Bulk Water Master Plan

MAP TITLE:

Total Bulk Water Supply Interventions - UG010: Vulamehlo Farming UGU District Municipality

DATE COMPLETED: January 2021

MAP NO.: DC 21 Figure 9-20

Proposed New / Upgrade Infrastructure

Vulamehlo Water Scheme Areas & Names

- Existing Water Treatment Plants
- Surface Water Abstraction Works (Existing)
- Primary Bulk Pipelines (Existing)
- Secondary Bulk Pipelines (Existing)
- Tertiary Bulk Pipelines (Existing)
- Primary Reservoirs (Existing)
- Secondary Reservoirs (Existing)
- Tertiary Reservoirs (Existing)
- Upgrade of WTW
- Surface Water Abstraction Works (Future)
- Primary Bulk Pipelines (Future)
- Secondary Bulk Pipelines (Future)
- Tertiary Bulk Pipelines (Future)
- Primary Command Reservoirs (Future)
- Secondary Reservoirs (Future)
- Tertiary Reservoirs (Future)



Mzumb

Mzumb

Umdoni Local Municipality

Ray Nkonyeni Local Municipality

Umzumb Local Municipality

Vulamehlo Farming Scheme

Ugu

Kwa-Malukaka

Mwalume

Fafa



Figure 9-21
UG010 WSIA: Vulamehlo Farming

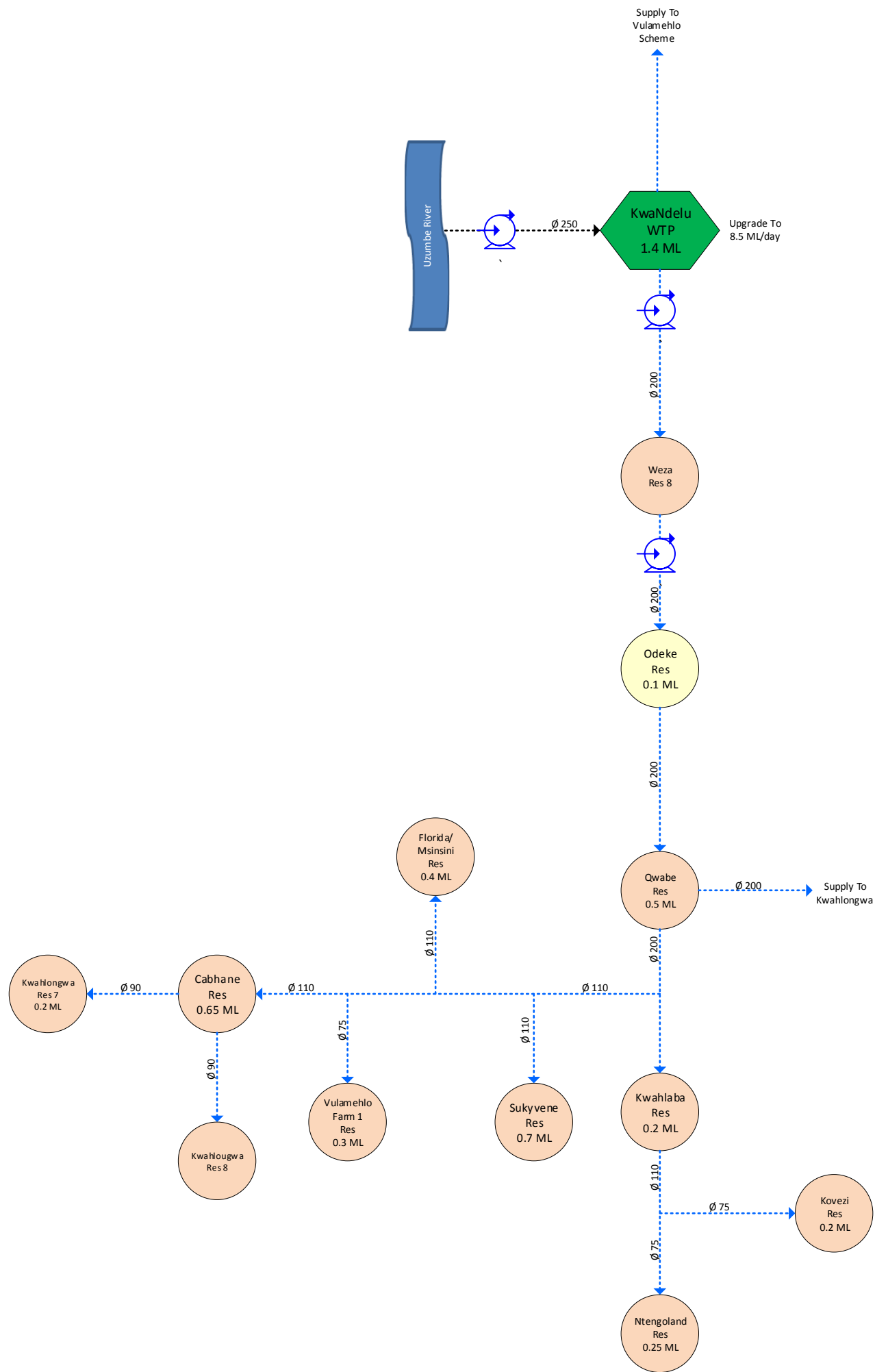

LEGEND

- Raw Water**
- Clarified Water**
- Treated Water**
 - Existing Primary Bulk**
 - Existing Secondary Bulk**
 - Existing Tertiary Bulk**
 - Future Primary Bulk**
 - Future Secondary Bulk**
 - Future Tertiary Bulk**
- Res 23 (0.4 ML)** **Existing Reservoir**
- Res 24 (0.92 ML)** **Future Reservoir**

All diameters in mm
All flows in ML/day

9.11 UG011 WSIA: VULAMEHLO WATER SUPPLY SCHEME

9.11.1 Demand Model Intervention

9.11.1.1 Water Demand

The water demand for the Vulamehlo WSIA was determined for 2020 and 2050 and included within **Table 9-21**.

Table 9-20: Population and Water demand 2020 and 2050 for the Vulamehlo WSIA

Population	Population 2020	Population 2050
	7 110	11 421
Water Demand	Demand 2020	Demand 2050
	1.19	1.99

9.11.1.2 Water Resource Consideration

The Vulamehlo Scheme distributes water from an extension of the Ndelu Water Scheme to supply the rural areas of Vulamehlo. The scheme areas supplied by the scheme include Gubhuza, Mpongozini and Kagoleta.

Another section of the Vulamehlo Water Supply Scheme is supplied from the KwaCele Reservoir which forms part of the Vulamehlo Cross Border Scheme.

Water resource considerations for the scheme are covered under the planning for the KwaNdelu Water Supply Scheme.

9.11.2 Water Supply Infrastructure

The following infrastructure upgrades and augmentation will be required in order to adequately supply the Vulamehlo Scheme WSIA and is illustrated within **Figure 9-22** followed by the schematic layout of the WSIA within **Figure 9-23**.

9.11.2.1 Bulk Conveyance and Storage

Potable water will be pumped from the KwaNdelu WTP to the proposed 0.5Ml Gangazolo Reservoir. From Gangazolo, water gravitates via a 75mm Ø pipeline to Betania and Izotsha reservoirs.

9.11.2.2 Proposed Interventions

Water resource interventions are covered in the KwaNdelu Water Supply Scheme and in the Vulamehlo Cross Border Water Supply Scheme section.

Further to the above, the following upgrades will be required:

- ✓ The pipeline from the Gangazolo to Izotsha and Betania reservoir should be upgrade to 110mmØ pipeline; and
- ✓ The Betania reservoir will supply the proposed Gubhuza reservoir via a 90mmØ pipeline

There are areas of Vulamehlo Scheme that are not covered by the KwaNdelu Scheme. These areas are covered under the Greater Vulamehlo Cross Border Scheme (GVCBSS) that requires the the following interventions:

- ✓ Bulk supply line from KwaCele No. 2 Reservoir (GVCBSS) to Kagoleta/Mpongozini reservoir to be upgraded to 90mmØ;
- ✓ A proposed 75mm Ø offtake to the Woodgrange and Harding 1-2-3 reservoirs;
- ✓ The Harding 0.2 Ml Reservoir; and
- ✓ The Woodgrange 0.1 Ml Reservoir.

9.11.3 Financial Requirements

The bulk cost requirement for Vulamehlo WSIA is summarised within **Table 9-22** below.







Table 9-21: UG011 Vulamehlo Scheme Cost Requirement

	Capital Cost	10% Contingencies	Total Cost (Excl VAT)
Primary	R0.00	R0.00	R0.00
Secondary	R16 786 394.92	R1 678 639.49	R18 465 034.41
Tertiary	R2 895 175.76	R289 517.58	R3 184 693.34
Total	R19 681 570.68	R1 968 157.07	R21 649 727.75

The total bulk cost requirement for the Vulamehlo Scheme is R21 649 727.75 (excl VAT). The scheme development cost per household is approximately R 7 600.



Legend

-  Provincial Boundaries
-  District Municipality Boundaries
-  Local Municipality Boundaries
-  Dams & Dam Names
-  Rivers
-  Settlements
-  Major Towns

Ubuhebezwe
Local
Municipality
Harry Gwala

Vulamehlo
Scheme
Ugu
Umzumbe Local
Municipality

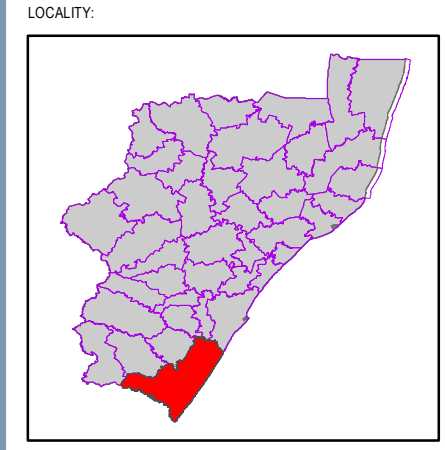

CLIENT:



MUNICIPALITY:



UGU DISTRICT MUNICIPALITY

CONSULTANTS Project No.: 27814



Mariswe
PO Box 25549, Monument Park
Pretoria, 0105

Tel: +27 (0) 12 424 9700
Fax: +27 (0) 12 460 4071
Email: pretoria@uwp.co.za

PROJECT TITLE

















**UGU DM: Universal
Access Plan Phase III -
Progressive Development of a
Regional Concept Secondary
Bulk Water Master Plan**

MAP TITLE: **Total Bulk Water Supply
Interventions -
Vulamehlo
UGU District Municipality**

DATE COMPLETED: **January 2021**

MAP NO.: **DC 21 Figure 9-22**

Proposed New / Upgrade Infrastructure

 Water Scheme Areas & Names	 Upgrade of WTW
 Existing Water Treatment Plants	 Surface Water Abstraction Works (Future)
 Surface Water Abstraction Works (Existing)	 Primary Bulk Pipelines (Future)
 Primary Bulk Pipelines (Existing)	 Secondary Bulk Pipelines (Future)
 Secondary Bulk Pipelines (Existing)	 Tertiary Bulk Pipelines (Future)
 Tertiary Bulk Pipelines (Existing)	 Primary Command Reservoirs (Future)
 Primary Reservoirs (Existing)	 Secondary Reservoirs (Future)
 Secondary Reservoirs (Existing)	 Tertiary Reservoirs (Future)
 Tertiary Reservoirs (Existing)	

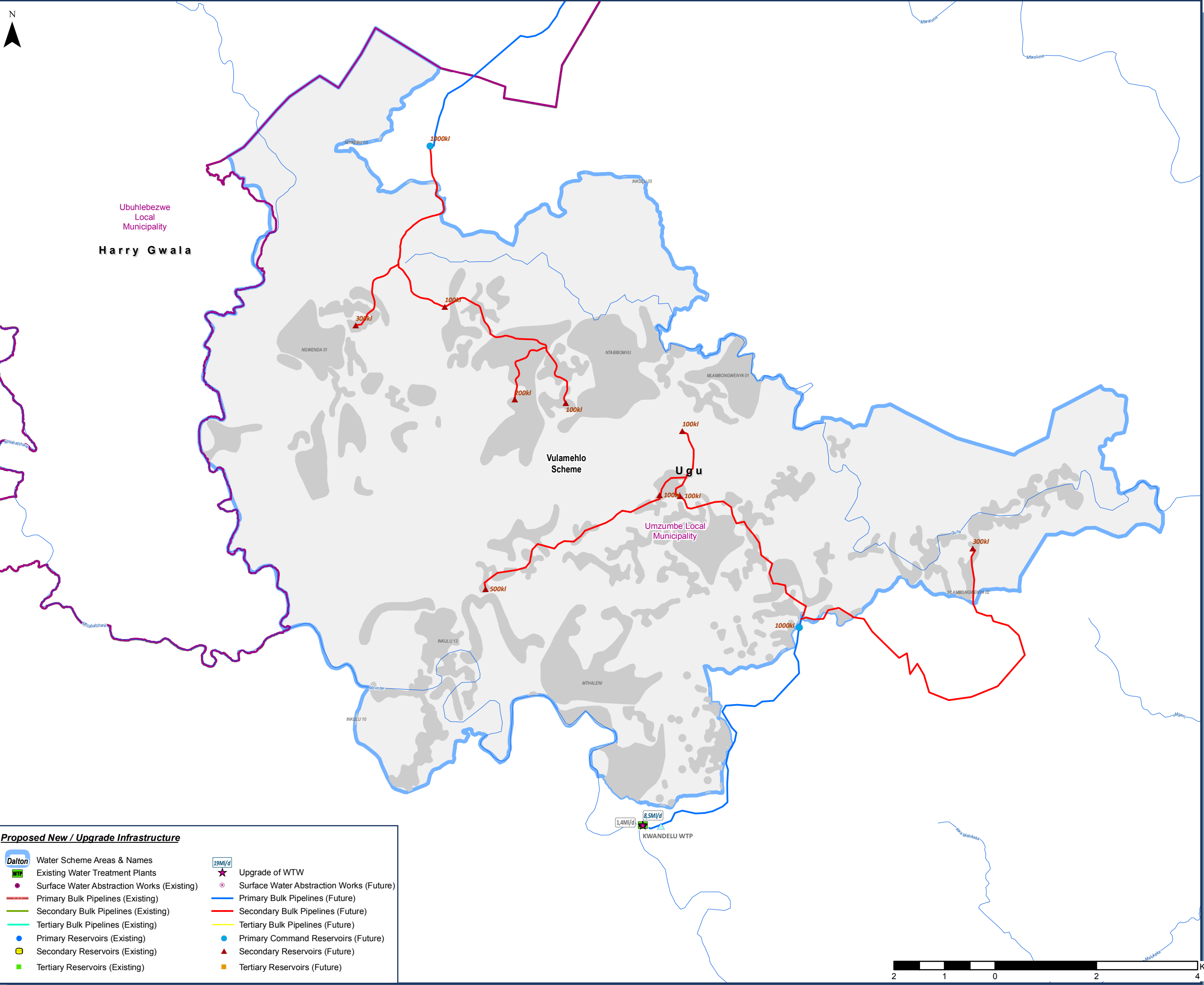
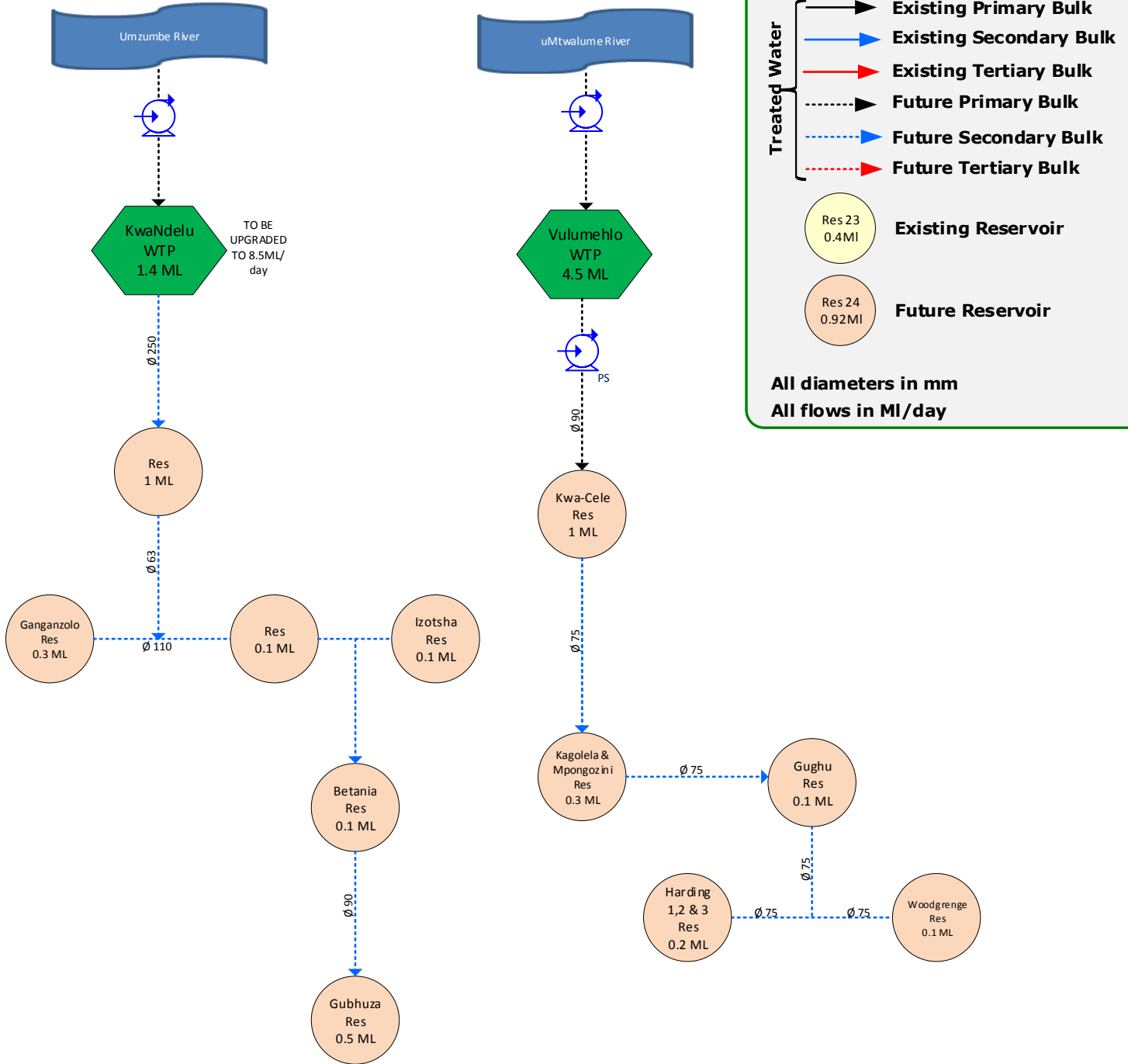

Figure 9-23
UG011 WSIA: VULAMEHLO SCHEME



9.12 UG012 WSIA: VULAMEHLO CROSS BORDER WATER SUPPLY SCHEME

9.12.1 Demand Model Intervention

9.12.1.1 Water Demand

The water demand for the Vulamehlo Cross Border Scheme Area was determined for 2020 and 2050 and included within **Table 9-23** below

Table 9-22: Population and Water demand 2020 and 2050 for the Vulamehlo Cross Border Scheme Area

Population	Population 2020	Population 2050
		51 553
Water Demand	Demand 2020 (Mℓ/day)	Demand 2050 (Mℓ/day)
		14.44

9.12.1.2 Water Resource Consideration

Water supply to the Vulamehlo Cross Border Scheme is currently sourced from Upper Mtwalume River via an existing weir. The river has a yield of 1.6Mℓ/day at the abstraction point. The raw water is treated at the 4.5 Mℓ/day capacity Vulamehlo WTP. According to the Umgeni Water UAP Phase 2 Report, the Vulamehlo WTP is planned to be upgraded to 10.2 Mℓ/day following the construction of a proposed dam on the Upper Mtwalume River.

The scheme also provides water to areas in the neighbouring Harry Gwala District Municipality. The demand from the HGDM is 3.42Mℓ/day. The total 2050 demand for the scheme is thus 15.1Mℓ/day and the existing and planned water resource and treatment capacity will not be adequate to supply the 2050 demand.

According to the Ugu UAP Phase II report, the raw water capacity of the scheme can be increased to 28Mℓ/day by constructing the Vulamehlo Dam upstream of the existing abstraction weir.

A prefeasibility study was undertaken for the Vulamehlo Dam. This dam will increase the yield of the system to 3.7 Mm³/day (10.2 Mℓ/day). (Bigen Africa, 2016) Only then will the following interventions be possible.

9.12.2 Water Supply Infrastructure

The following infrastructure upgrades will be required in order to adequately supply Vulamehlo Cross Border Scheme Area WSIA and is illustrated within **Figure 9-24** with the schematic layout of the WSIA depicted in **Figure 9-25**.

9.12.2.1 Bulk conveyance and Storage

- ✓ Water will be pumped via a 250mm ø pipeline south of Vulamehlo WTP to supply KwaMaqikizane Reservoir;
- ✓ The KwaMaqikizane Reservoir will supply water to Mthwalume Reservoir via a 90mm ø pipeline;

- ✓ Further pumping will be required from the KwaMaqikizane reservoir to the Hlokozi Reservoir via a 200mm \varnothing pipeline;
- ✓ The Hlokozi Reservoir will be the primary source of supply to the areas of Mzumbe, Nyavini and Sangqu via proposed secondary reservoirs;
- ✓ Water will also need to be pumped North of Vulamehlo WTP via a 400mm \varnothing pipeline to the proposed KuMpotoshosi Reservoir; and
- ✓ The KuMpotoshosi Reservoir will be the primary source of supply to the areas of Kenterton, Dumisa, Mbulula and Mayfield. A 250mm \varnothing off-take pipeline via the KuMpotoshosi Reservoir to Mayfield Reservoir pipeline will supply the areas of Oshambe and St. Nivad's.

9.12.2.2 Proposed Interventions

- ✓ Implementation of the Vulamehlo Dam and a hydrological study to increase the yield for downstream supply to a proposed weir to supply the uMtwalume Scheme Area.
- ✓ Upgrading of raw water supply source from 4.5 M ℓ /day to 28 M ℓ /day;
 - Upgrading of Mtwalume WTP to 8 M ℓ /day to meet the 2050 demand;
 - Upgrading of existing bulk supply mains;
 - Offtake to Sangqu to 90mm \varnothing ;
 - Hlokozi offtake to Nyavini 160mm \varnothing ;
 - Offtake Nyavini to 90mm \varnothing ;
 - Hlokozi offtake to Mzumbe 160mm \varnothing ;
 - Hlokozi main 75mm \varnothing ;
 - Kwamnjikizane to Hlokozi 200mm \varnothing ;
 - Kwamnjikizane to Mthwalume 90mm \varnothing ;
 - Mayfield 160mm \varnothing ;
 - Offtake to Braemar 160mm \varnothing ;
 - Offtake to Oshambe 250mm \varnothing ;
 - Offtake to St. Nivads 160mm \varnothing ;
 - Offtake to Mbulula 75mm \varnothing ;
 - To Mayfield 160mm \varnothing ;
 - To Dumisa 300mm \varnothing ;
 - Kumpotoshosi to Mayfield 300mm \varnothing ;
 - Offtake to Kenterton 160mm \varnothing ;
 - WTP to Kumpotshosi 400mm \varnothing ;
 - WTP to KwaMaqikizane 200mm \varnothing ;
- ✓ Proposed new and existing reservoir upgrades

- Sanqu - 0.5 Mℓ
- Nyavini - 0.5 Mℓ
- Mzumbe - 0.2 Mℓ;
- Hlokozi - 2.5 Mℓ
- kwamnqikizane - 4 Mℓ;
- Mthwalume - 0.5 Mℓ;
- Mayfield -1 Mℓ;
- St Nivads -1.5 Mℓ;
- Oshambe -2 Mℓ;
- Braemar -1 Mℓ;
- Mbulula - 0.3 Mℓ;
- Dumisa - 0.6 Mℓ;
- Kenterton - 1 Mℓ; and
- Kumpotoshosi - 11 Mℓ.

Design details of all the infrastructure components are provided within **Annexure B**.

9.12.3 Financial Requirements

The bulk cost requirement for Vulamehlo Cross Border WSIA is summarised within **Table 9-24** below.

Table 9-23: UG012 Vulamehlo Cross Border Scheme Cost Requirement

	Capital Cost	10% Contingencies	Total Cost (Excl VAT)
Primary	R915 479 269.49	R91 547 926.95	R1 007 027 196.44
Secondary	R199 328 659.08	R19 932 865.91	R219 261 524.98
Tertiary	R53 219 704.65	R5 321 970.46	R58 541 675.11
Total	R1 168 027 633.21	R116 802 763.32	R1 284 830 396.53

The total bulk cost requirement for the Vulamehlo Cross Border Scheme is R1 284 830 396.53 (excl VAT). The scheme development cost per household is approximately R 62 000.

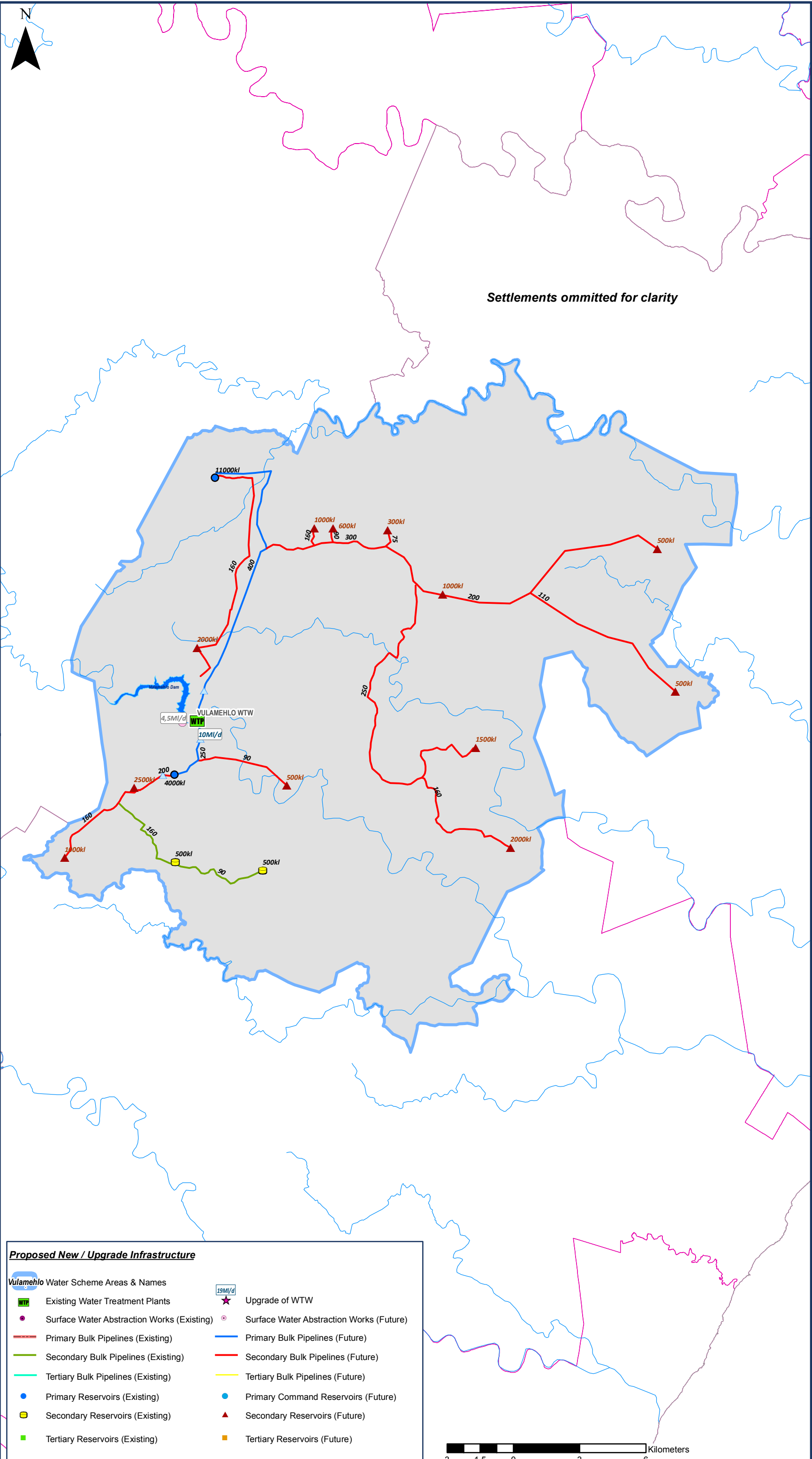

Settlements omitted for clarity

Proposed New / Upgrade Infrastructure

Vulamehlo Water Scheme Areas & Names

Existing Water Treatment Plants	Upgrade of WTW
Surface Water Abstraction Works (Existing)	Surface Water Abstraction Works (Future)
Primary Bulk Pipelines (Existing)	Primary Bulk Pipelines (Future)
Secondary Bulk Pipelines (Existing)	Secondary Bulk Pipelines (Future)
Tertiary Bulk Pipelines (Existing)	Tertiary Bulk Pipelines (Future)
Primary Reservoirs (Existing)	Primary Command Reservoirs (Future)
Secondary Reservoirs (Existing)	Secondary Reservoirs (Future)
Tertiary Reservoirs (Existing)	Tertiary Reservoirs (Future)



Legend

- Provincial Boundaries
- District Municipality Boundaries
- Local Municipality Boundaries
- National Roads
- Main Roads
- Dams & Dam Names
- Rivers
- Settlements
- Major Towns

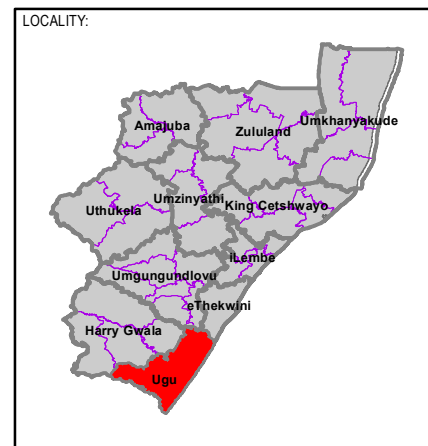

CLIENT:

MUNICIPALITY:

UMGUNGUNDLOVU DISTRICT MUNICIPALITY

CONSULTANTS

Project No.: 27814

Mariswe
PO Box 25549, Monument Park
Pretoria, 0105

Tel: +27 (0) 12 424 9700
Fax: +27 (0) 12 460 4071
Email: pretoria@uwp.co.za

PROJECT TITLE

Ugu DM: Universal Access Plan Phase III - Progressive Development of a Regional Concept Secondary Bulk Water Master Plan

MAP TITLE:

Total Bulk Water Supply Interventions - UG011: Vulamehlo Cross Border Ugu District Municipality

DATE COMPLETED:

January 2021

MAP NO.:

DC 21 Figure 9-24

Figure 9-25
UG012 WSIA: GREATER VULAMEHLO CROSS BORDER

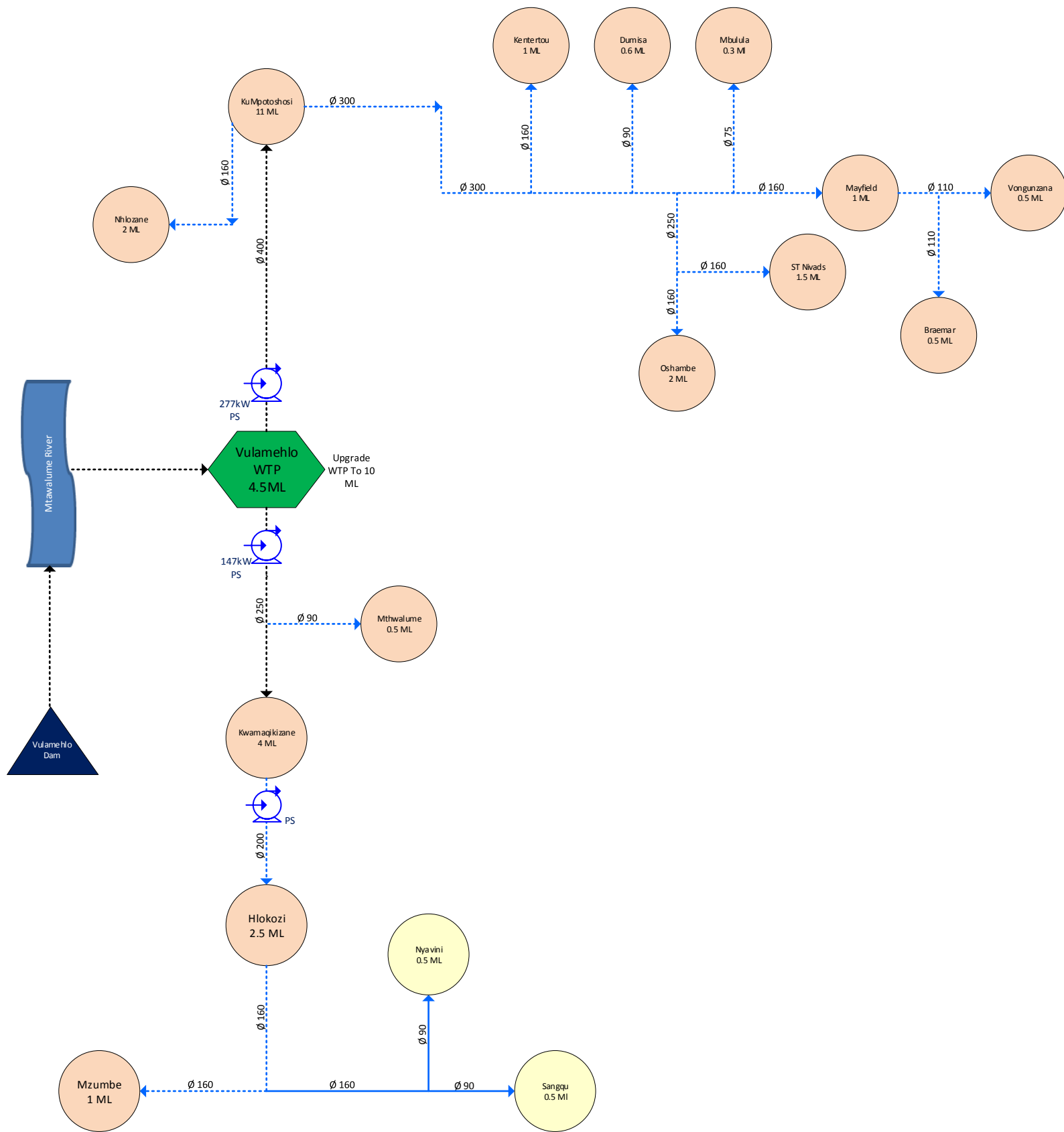

LEGEND

- Raw Water
- Clarified Water
- Treated Water**
 - Existing Primary Bulk
 - Existing Secondary Bulk
 - Existing Tertiary Bulk
 - Future Primary Bulk
 - Future Secondary Bulk
 - Future Tertiary Bulk
- Res 23
0.4MI Existing Reservoir
- Res 24
0.92MI Future Reservoir

All diameters in mm
All flows in MI/day

9.13 UG013 WSIA: KwAMBOTHO WATER SUPPLY SCHEME

9.13.1 Demand Model Intervention

9.13.1.1 Water Demand

The water demand for the KwaMbotho Bulk Water Supply Scheme was determined for 2020 and 2050 and included within **Table 9-25** below.

Table 9-24: Population and Water demand 2020 and 2050 for the kwaMbotho WSS

Population	Population 2020	Population 2050
	161 15	258 87
Water Demand	Demand 2020	Demand 2050
	2.84	4.77

9.13.1.2 Water Resource Consideration¹¹

The kwaMbotho Supply Scheme abstracts and treats water from the Ncekete River for the supply to the rural areas of kwa-Mbotho. The yield of the current source is not known. The future plan is to decommission the source and WTP of this scheme and incorporate it into the Harding Weza Scheme.

The investigations detailed in section 9.5 will need to be carried out to confirm the water water resource availability for the Kwa-Mbotho Scheme. Only then will the following interventions be possible.

9.13.2 Water Supply Infrastructure

The following infrastructure upgrades and augmentation will be required in order to adequately supply the KwaMbotho WSIA and is illustrated within **Figure 9-26** followed by the schematic layout of the WSIA within **Figure 9-27**.

9.13.2.1 Bulk conveyance and Storage

- ✓ Potable water will be pumped from the Harding WTP, via one stage pumping to the 5 Ml Kwa-Mbotho Command Reservoir (854 m) through a \varnothing 250mm bulk rising main; and
- ✓ Water will then be distributed to storage reservoirs via secondary and tertiary distribution mains (pipe sizes ranging from 75 mm \varnothing to 250 mm \varnothing) to supply the Marchmont, Bhidla, Kuzameni, Gansa, and Ntshangala areas.

¹¹ Sourced from the UAP Phase II Study

9.13.2.2 Proposed interventions

- ✓ A bulk main and pumpstation will be required to pump water from the Harding WTP to the proposed kwaMbotho Command Reservoir;
- ✓ The existing Kwambotho Command Reservoir should be upgraded to 5Mℓ;
- ✓ The existing Kwambotho Reservoir 1 should be upgraded to 1Mℓ;
- ✓ The existing Kwambotho Reservoir 2 should be upgraded to 1.5Mℓ;
- ✓ The existing Kwambotho Reservoir 3 should be upgraded to 0.7Mℓ;
- ✓ The existing Kwambotho Reservoir 4 should be upgraded to 2.5Mℓ;
- ✓ The existing rising main to Kwambotho Command Reservoir should be upgraded to ø 250 mm;
- ✓ The existing secondary bulk main to Kwambotho Reservoir 1 should be upgraded ø 150mm;
- ✓ The existing secondary bulk main to Kwambotho Reservoir 2 should be upgraded to ø 150mm;
- ✓ The existing secondary bulk main to Kwambotho Reservoir 3 should be upgraded to ø 110 mm; and
- ✓ The existing tertiary bulk main to Kwambotho Reservoir 4 should be upgraded to ø 75mm

9.13.3 Financial Requirements

The bulk cost requirement for KwaMbotho WSIA is summarised within **Table 9-26** below.

Table 9-25: UG013 KwaMbotho Scheme Cost Requirement

	Capital Cost	10% Contingencies	Total Cost (excl VAT)
Primary	R0.00	R0.00	R0.00
Secondary	R60 009 428.16	R6 000 942.82	R66 010 370.98
Tertiary	R16 475 957.33	R1 647 595.73	R18 123 553.06
Total	R76 485 385.49	R7 648 538.55	R84 133 924.04

The total bulk cost requirement for the KwaMbotho Scheme is R84 133 924.04 (excl VAT). The scheme development cost per household is approximately R 13 000.

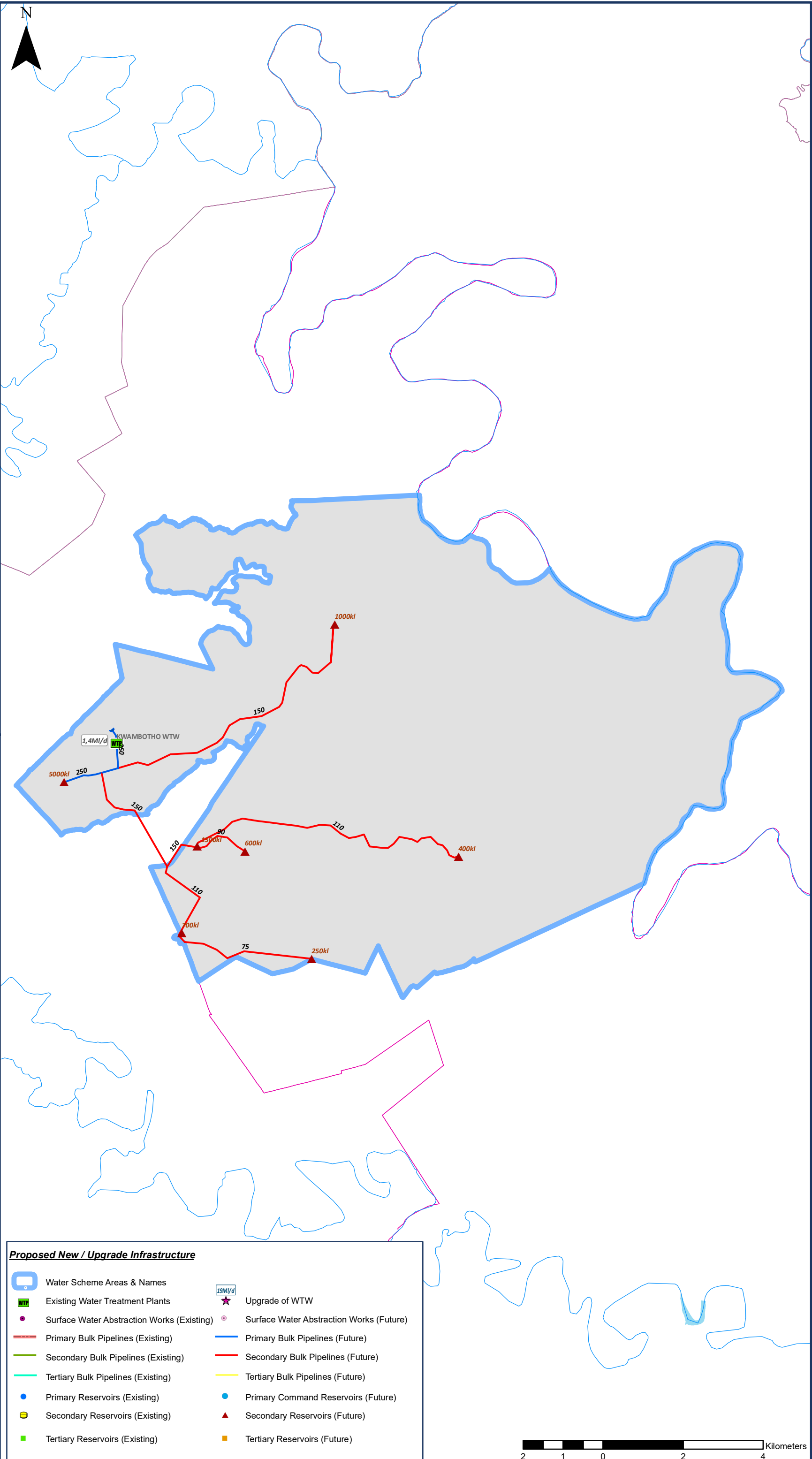

Proposed New / Upgrade Infrastructure

Water Scheme Areas & Names	Upgrade of WTW
Existing Water Treatment Plants	Surface Water Abstraction Works (Future)
Surface Water Abstraction Works (Existing)	Primary Bulk Pipelines (Future)
Primary Bulk Pipelines (Existing)	Secondary Bulk Pipelines (Future)
Secondary Bulk Pipelines (Existing)	Tertiary Bulk Pipelines (Future)
Tertiary Bulk Pipelines (Existing)	Primary Command Reservoirs (Future)
Primary Reservoirs (Existing)	Secondary Reservoirs (Future)
Secondary Reservoirs (Existing)	Tertiary Reservoirs (Future)
Tertiary Reservoirs (Existing)	



Legend

- Provincial Boundaries
- District Municipality Boundaries
- Local Municipality Boundaries
- National Roads
- Main Roads
- Dams & Dam Names
- Rivers
- Settlements
- Major Towns

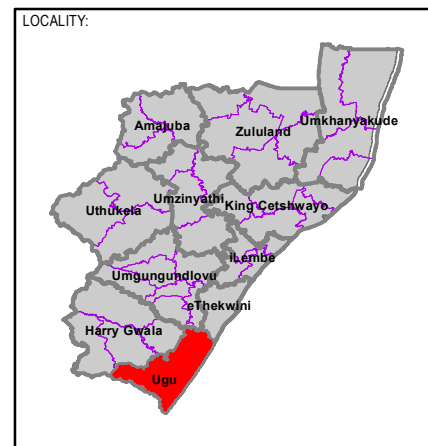

CLIENT:

MUNICIPALITY:

UGU DISTRICT MUNICIPALITY

CONSULTANTS

Project No.: 27814

Mariswe
PO Box 25549, Monument Park
Pretoria, 0105

Tel: +27 (0) 12 424 9700
Fax: +27 (0) 12 460 4071
Email: pretoria@uwp.co.za

PROJECT TITLE

Ugu DM: Universal Access Plan Phase III - Progressive Development of a Regional Concept Secondary Bulk Water Master Plan

MAP TITLE:

Total Bulk Water Supply Interventions - UG013: KwaMbotho Ugu District Municipality

DATE COMPLETED:

January 2021

MAP NO.:

DC 21 Figure 9-26

Figure 9-27
UG013 WSIA: Kwa-Mbotho

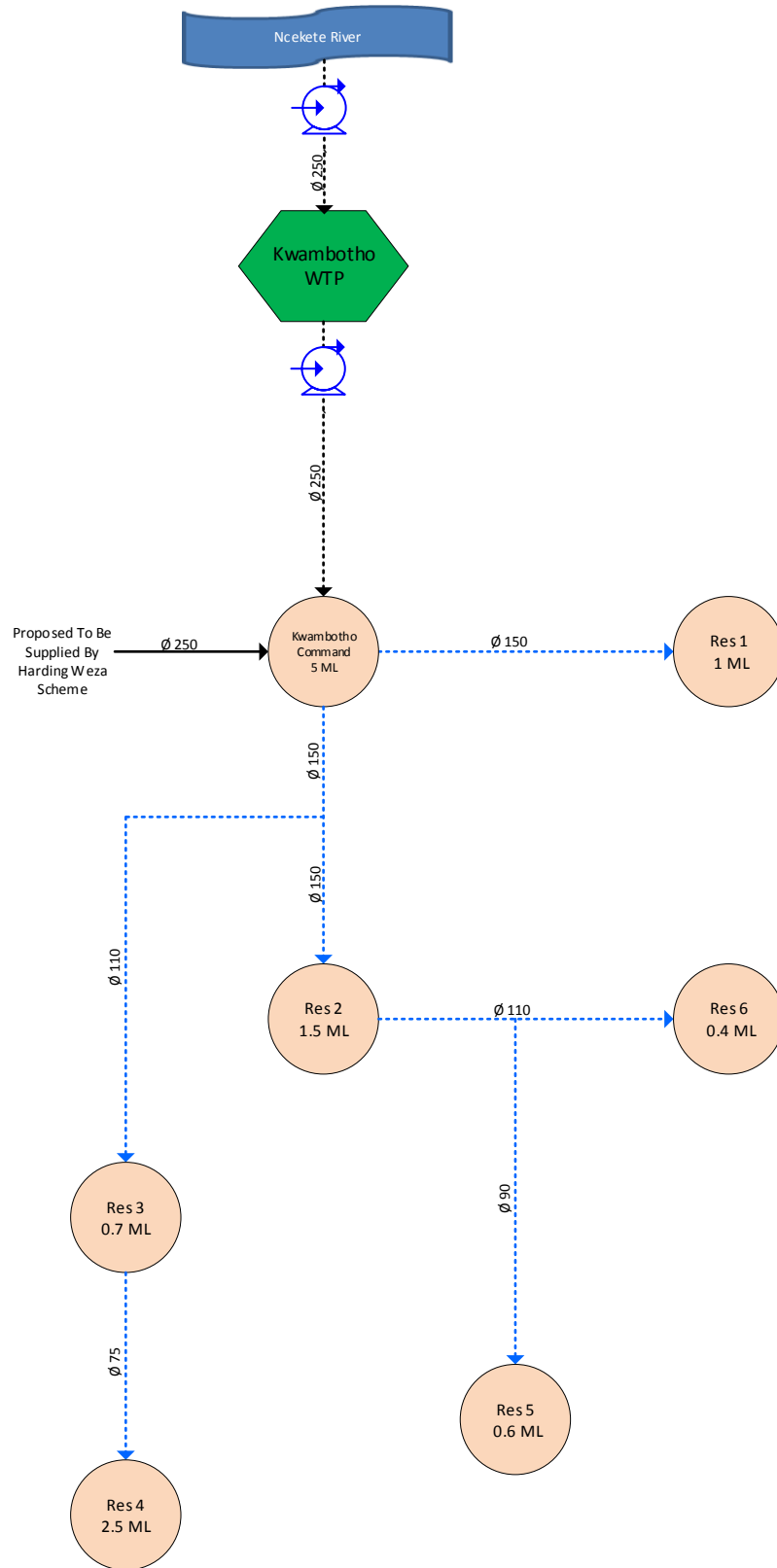

LEGEND

- Raw Water
- Clarified Water
- Treated Water**
 - Existing Primary Bulk
 - Existing Secondary Bulk
 - Existing Tertiary Bulk
 - Future Primary Bulk
 - Future Secondary Bulk
 - Future Tertiary Bulk
- Res 23 (0.4ML) Existing Reservoir
- Res 24 (0.92ML) Future Reservoir

All diameters in mm
 All flows in Ml/day

9.14 UG014 WSIA: KwaNYUSWA WATER SUPPLY SCHEME

9.14.1 Demand Model Intervention

9.14.1.1 Water Demand

The water demand for KwaNyuswa WSIA was determined for 2020 and 2050 and included within **Table 9-27**.

Table 9-26: Population and Water demand 2020 and 2050 for KwaNyuswa WSIA

Population	Population 2020	Population 2050
	11 142	17 898
Water Demand	Demand 2020 (Mℓ/day)	Demand 2050 (Mℓ/day)
	1.93	3.24

9.14.1.2 Water Resource Consideration

The Kwanyuswa Scheme has two (2) WTPs that supply the scheme area. KwaNyuswa WTP 1 - Abstracts water from a local river for the supply to the high and low areas of kwaNyuswa. This WTP has a capacity of 0.25Mℓ/day. KwaNyuswa WTP 2 extracts water from Gilbert Eyles Dam, the yield of the source and the capacity of the WTP is unknown.

The raw water sources and the WTP's do not have adequate capacity for current demand and are thus taken to not have adequate capacity for the 2050 demand.

The future plan is to supply this scheme from the Harding/Weza Scheme via the KwaMbotho Scheme, and its existing abstraction and treatment infrastructure will be decommissioned.

The investigations detailed in section 9.5 will need to be carried out to confirm the water resource availability for the Kwa-Mbotho Scheme. Only then will the following interventions be possible.

9.14.2 Water Supply Infrastructure

The following infrastructure upgrades and augmentation will be required in order to adequately supply the kwaNyuswa Scheme WSIA and is illustrated within **Figure 9-28** followed by the schematic layout of the WSIA within **Figure 9-29**.

9.14.2.1 Proposed Interventions

The following interventions will be required in order for the scheme to meet the 2050 demand.

- ✓ The existing pipeline from KwaMbotho Reservoir to the KwaNyuswa Command Reservoir will need to be upgraded to 160mm diameter;

- ✓ The existing pipeline from the KwaNyuswa command reservoir to KwaNyuswa A reservoir will need to be upgraded to 160mm diameter;
- ✓ KwaNyuswa Reservoir A will need to be upgraded to 1.2Mℓ; and
- ✓ The existing line from KwaNyuswa A reservoir to KwaNyuswa B reservoir will need to be upgraded to pipes ranging from 110mm diameter to 160mm diameter.

9.14.3 Financial Requirements

The bulk cost requirement for KwaNyuswa WSIA is summarised within **Table 9-28** below.

Table 9-27: UG014 KwaNyuswa Scheme Cost Requirement

	Capital Cost	10% Contingencies	Total Cost (Excl VAT)
Primary	R0.00	R0.00	R0.00
Secondary	R46 634 124.29	R4 663 412.43	R51 297 536.72
Tertiary	R20 965 950.07	R2 096 595.01	R23 062 545.07
Total	R67 600 074.36	R6 760 007.44	R74 360 081.79

The total bulk cost requirement for the KwaNyuswa Scheme is R74 360 081.79 (excl VAT). The scheme development cost per household is approximately R 16 600.



Legend

- Provincial Boundaries
- District Municipality Boundaries
- Local Municipality Boundaries
- National Roads
- Main Roads
- Dams & Dam Names
- Rivers
- Settlements
- Major Towns

LOCALITY:

CLIENT:

MUNICIPALITY:

UGU DISTRICT MUNICIPALITY

CONSULTANTS

Project No.: 27814

Mariswe
PO Box 25549, Monument Park
Pretoria, 0105

Tel: +27 (0) 12 424 9700
Fax: +27 (0) 12 460 4071
Email: pretoria@uwp.co.za

PROJECT TITLE

UGU DM: Universal Access Plan Phase III - Progressive Development of a Regional Concept Secondary Bulk Water Master Plan

MAP TITLE:

Total Bulk Water Supply Interventions - UG014: KwaNyuswa UGU District Municipality

DATE COMPLETED: January 2021

MAP NO.: DC 21 Figure 9-28

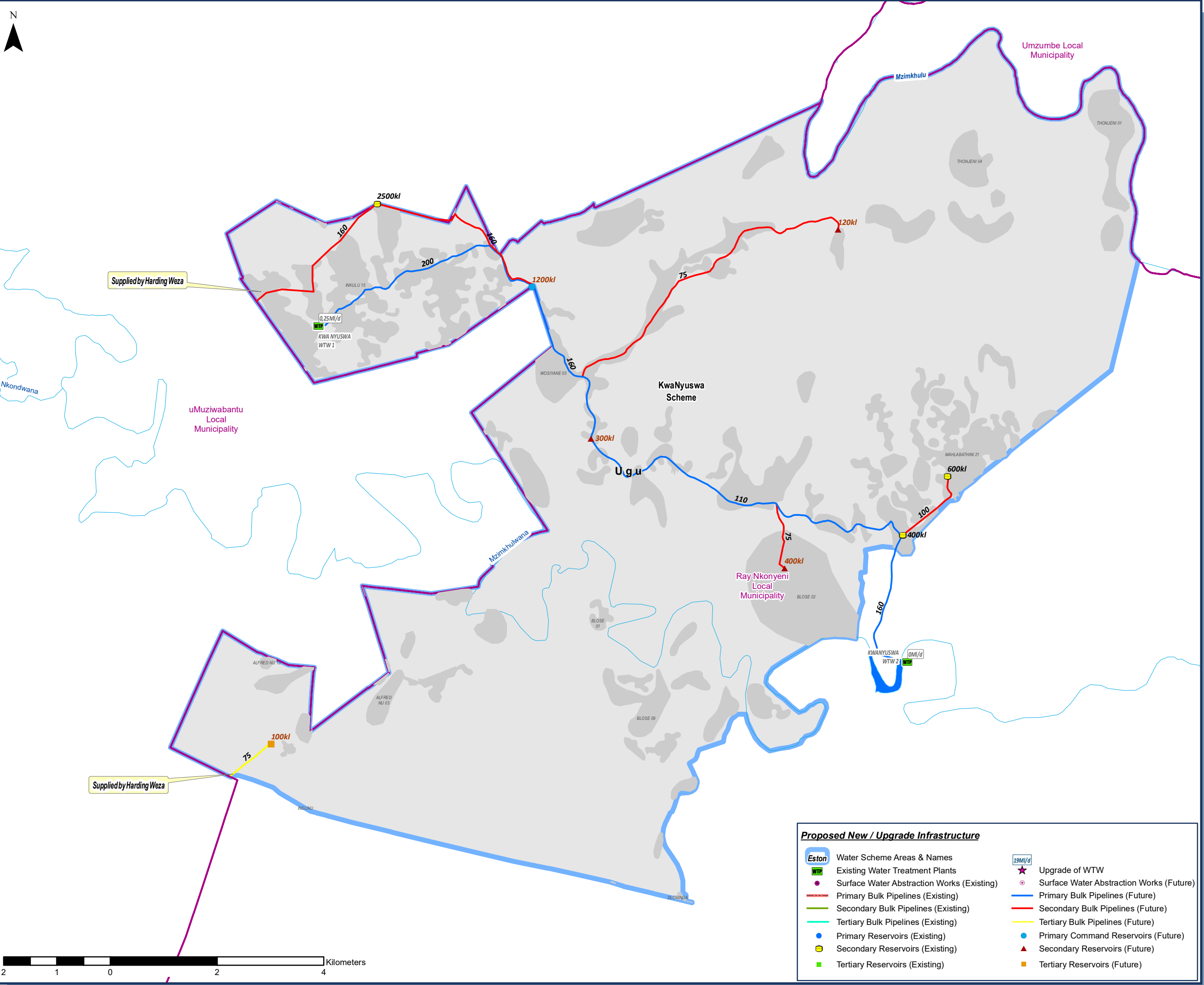

Proposed New / Upgrade Infrastructure

Water Scheme Areas & Names	Upgrade of WTW
Existing Water Treatment Plants	Surface Water Abstraction Works (Future)
Surface Water Abstraction Works (Existing)	Primary Bulk Pipelines (Future)
Primary Bulk Pipelines (Existing)	Secondary Bulk Pipelines (Future)
Secondary Bulk Pipelines (Existing)	Tertiary Bulk Pipelines (Future)
Tertiary Bulk Pipelines (Existing)	Primary Reservoirs (Existing)
Primary Reservoirs (Existing)	Primary Command Reservoirs (Future)
Secondary Reservoirs (Existing)	Secondary Reservoirs (Future)
Tertiary Reservoirs (Existing)	Tertiary Reservoirs (Future)



Figure 9-29
UG014 WSIA: KwaNyuswa

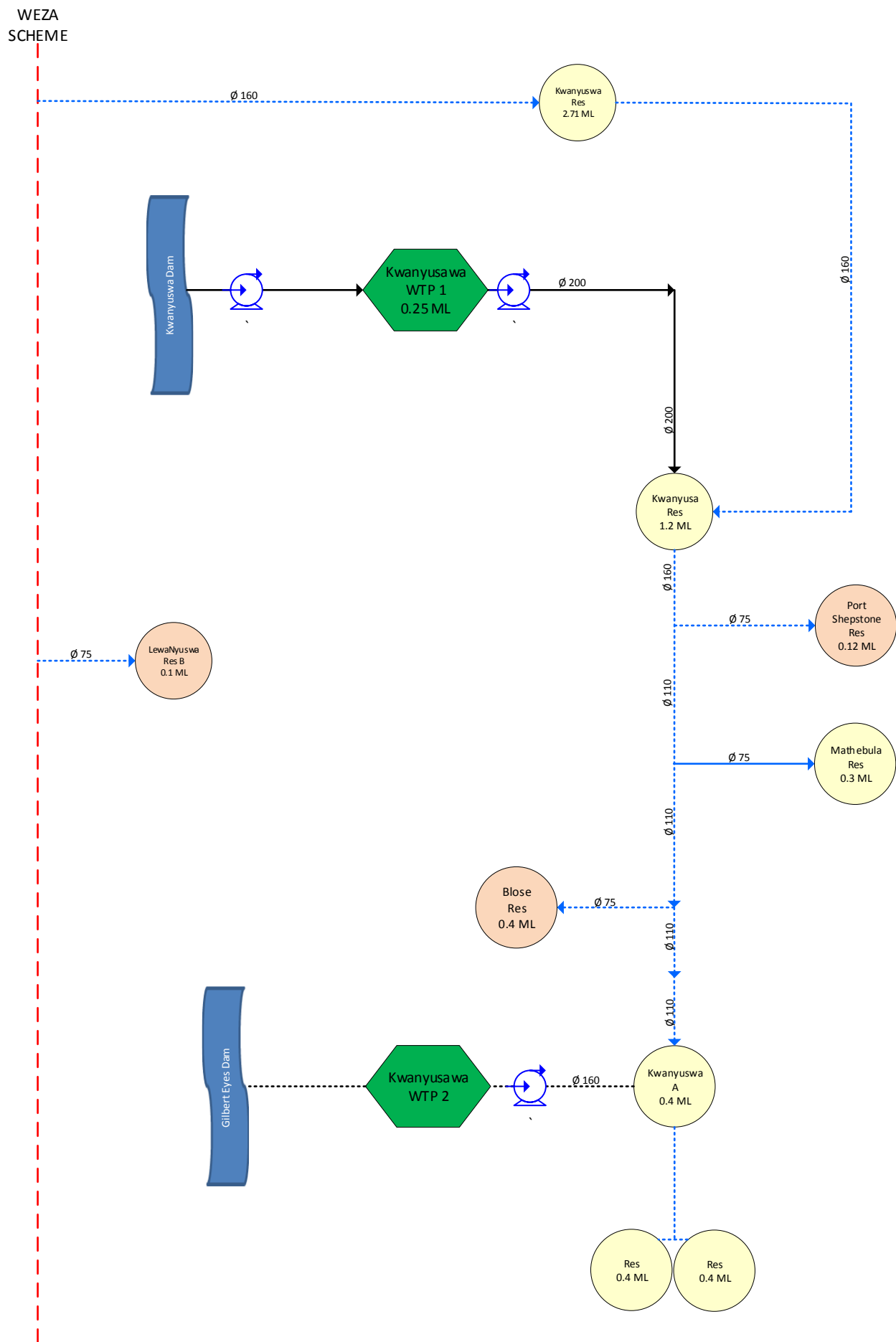

LEGEND

- Raw Water
- Clarified Water
- Treated Water**
 - Existing Primary Bulk
 - Existing Secondary Bulk
 - Existing Tertiary Bulk
 - Future Primary Bulk
 - Future Secondary Bulk
 - Future Tertiary Bulk
- Res 23 (0.4 ML) Existing Reservoir
- Res 24 (0.92 ML) Future Reservoir

All diameters in mm
All flows in ML/day

9.15 UG015 WSIA: KWANDELU WATER SUPPLY SCHEME

9.15.1 Demand Model Intervention

9.15.1.1 Water Demand

The water demand for the KwaNdelu WSIA was determined for 2020 and 2050 and included within **Table 9-29**.

Table 9-28: Population and Water demand 2020 and 2050 for the KwaNdelu WSIA

Population	Population 2020	Population 2050
	14 907	23 94
Water Demand	Demand 2020 (Mℓ/day)	Demand 2050 (Mℓ/day)
	2.50	4.19

9.15.1.2 Water Resource Consideration

The KwaNdelu Supply Scheme abstracts and treats water from the Mzumbe River for the supply to the rural areas of KwaNdelu. The Mzumbe River yields 4.4Mℓ/day while the KwaNdelu WTP has a capacity of 1.4Mℓ/day. The KwaNdelu WTP also supplies KwaHlongwa and the Vulamehlo Scheme. The existing raw water supply capacity is inadequate to cater for the projected 2050 demand.

The following alternative water resources have been considered to augment the water supply:

- ✓ Proposed Ncwabeni Dam; or
- ✓ Further hydrological studies to determine whether the yield can be upgraded to meet the 2050 demand of 8.5Mℓ/day by constructing an impoundment or off channel storage.

Only then will the following intervention be possible.

9.15.2 Water Supply Infrastructure

The following infrastructure upgrades and augmentation will be required in order to adequately supply the KwaNdelu Scheme WSIA and is illustrated within **Figure 9-30** followed by the schematic layout of the WSIA within **Figure 9-31**.

9.15.2.1 Proposed Interventions

- ✓ The KwaNdelu WTP should be upgraded to be upgraded to 8.5Mℓ/day. The demand includes the Vulamehlo Scheme, Kwahlongwa Scheme;
- ✓ The existing rising main pipeline from the KwaNdelu WTP to a proposed reservoir at Ganganzolo village should be upgraded to 200mmØ pipeline. The Ganganzolo reservoir will also supply Vulamehlo Scheme;

- ✓ The existing gravity pipeline from Ganganzolo reservoir to Bombo reservoir should be upgraded to 75mmØ pipeline;
- ✓ The existing pipeline from Qwabe reservoir to KwaHlongwa scheme should be upgraded to 200mmØ pipeline;
- ✓ The pipeline en route to KwaHlongwa scheme from a proposed offtake to KwaNdelu 1 and Egumbini reservoir should be upgraded to a 110mmØ pipeline;
- ✓ The pipeline from Qwabe reservoir to KwaHlaba reservoir should be upgraded to 160mmØ pipeline; and
- ✓ The pipeline from KwaHlaba to Vulamehlo Farming scheme should be upgraded to 110mmØ pipeline.

9.15.3 Financial Requirements

The bulk cost requirement for KwaNdelu WSIA is summarised within **Table 9-30** below.

Table 9-29: UG015 KwaNdelu Scheme Cost Requirement

	Capital Cost	10% Contingencies	Total Cost (Excl VAT)
Primary	R0.00	R0.00	R0.00
Secondary	R28 189 697.29	R2 818 969.73	R31 008 667.02
Tertiary	R17 179 811.03	R1 717 981.10	R18 897 792.13
Total	R45 369 508.32	R4 536 950.83	R49 906 459.15

The total bulk cost requirement for the KwaNdelu Scheme is R49 906 459.15 (excl VAT). The scheme development cost per household is approximately R 8 400.

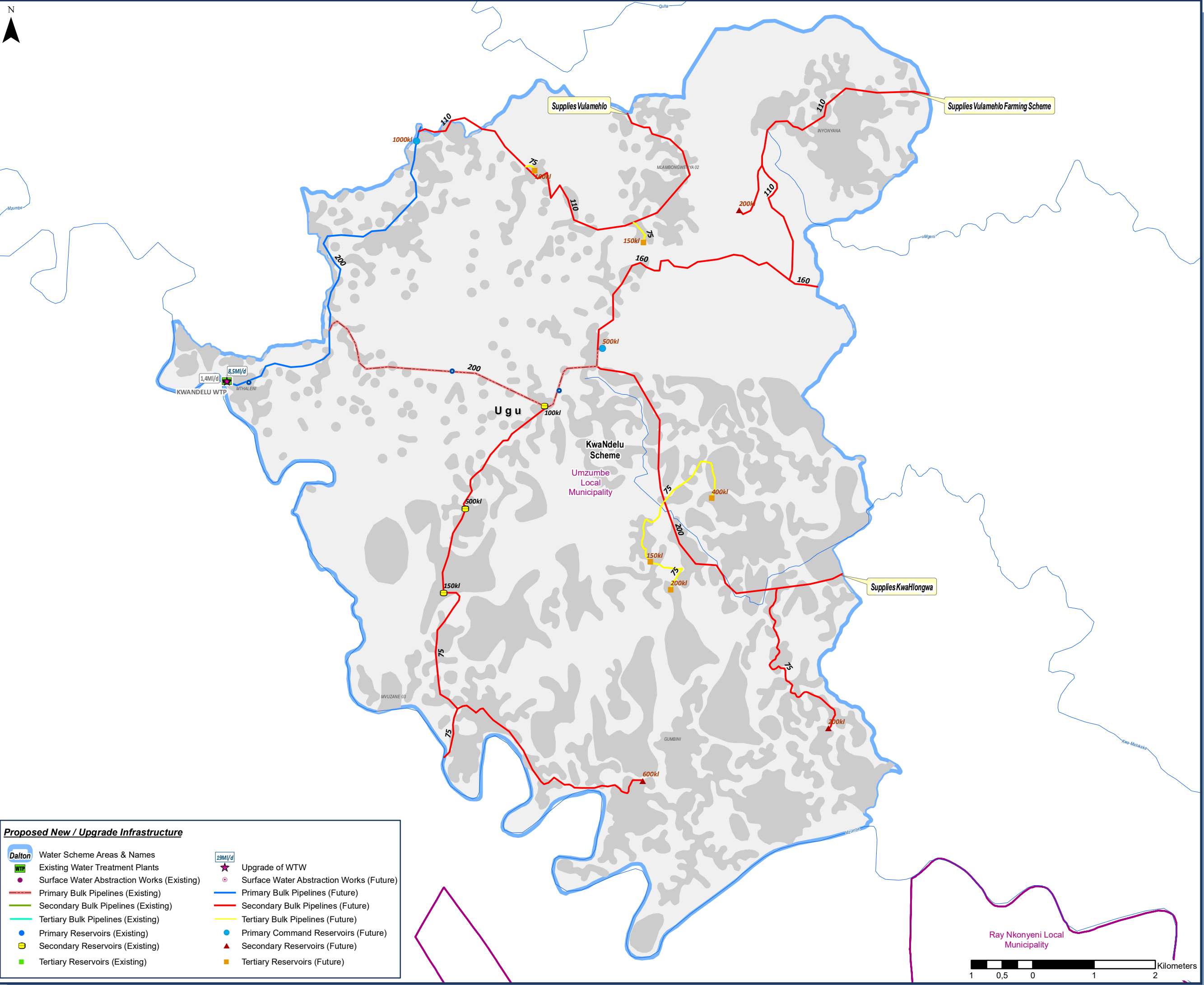

Legend

- Provincial Boundaries
- District Municipality Boundaries
- Local Municipality Boundaries
- Dams & Dam Names
- Rivers
- Settlements
- Major Towns

LOCALITY:

CLIENT:

MUNICIPALITY:

CONSULTANTS

Project No.: 27814

Mariswe
PO Box 25549, Monument Park
Pretoria, 0105

Tel: +27 (0) 12 424 9700
Fax: +27 (0) 12 460 4071
Email: pretoria@uwp.co.za

PROJECT TITLE

UGU DM: Universal Access Plan Phase III - Progressive Development of a Regional Concept Secondary Bulk Water Master Plan

MAP TITLE:

Total Bulk Water Supply Interventions - UG015: KwaNdelu UGU District Municipality

DATE COMPLETED:

January 2021

MAP NO.:

DC 21 Figure 9-30

Proposed New / Upgrade Infrastructure

Water Scheme Areas & Names	Upgrade of WTP
Existing Water Treatment Plants	Surface Water Abstraction Works (Future)
Surface Water Abstraction Works (Existing)	Primary Bulk Pipelines (Future)
Primary Bulk Pipelines (Existing)	Secondary Bulk Pipelines (Future)
Secondary Bulk Pipelines (Existing)	Tertiary Bulk Pipelines (Future)
Tertiary Bulk Pipelines (Existing)	Primary Command Reservoirs (Future)
Primary Reservoirs (Existing)	Secondary Reservoirs (Future)
Secondary Reservoirs (Existing)	Tertiary Reservoirs (Future)
Tertiary Reservoirs (Existing)	



Figure 9-31
UG015 WSIA: KwaNdelu

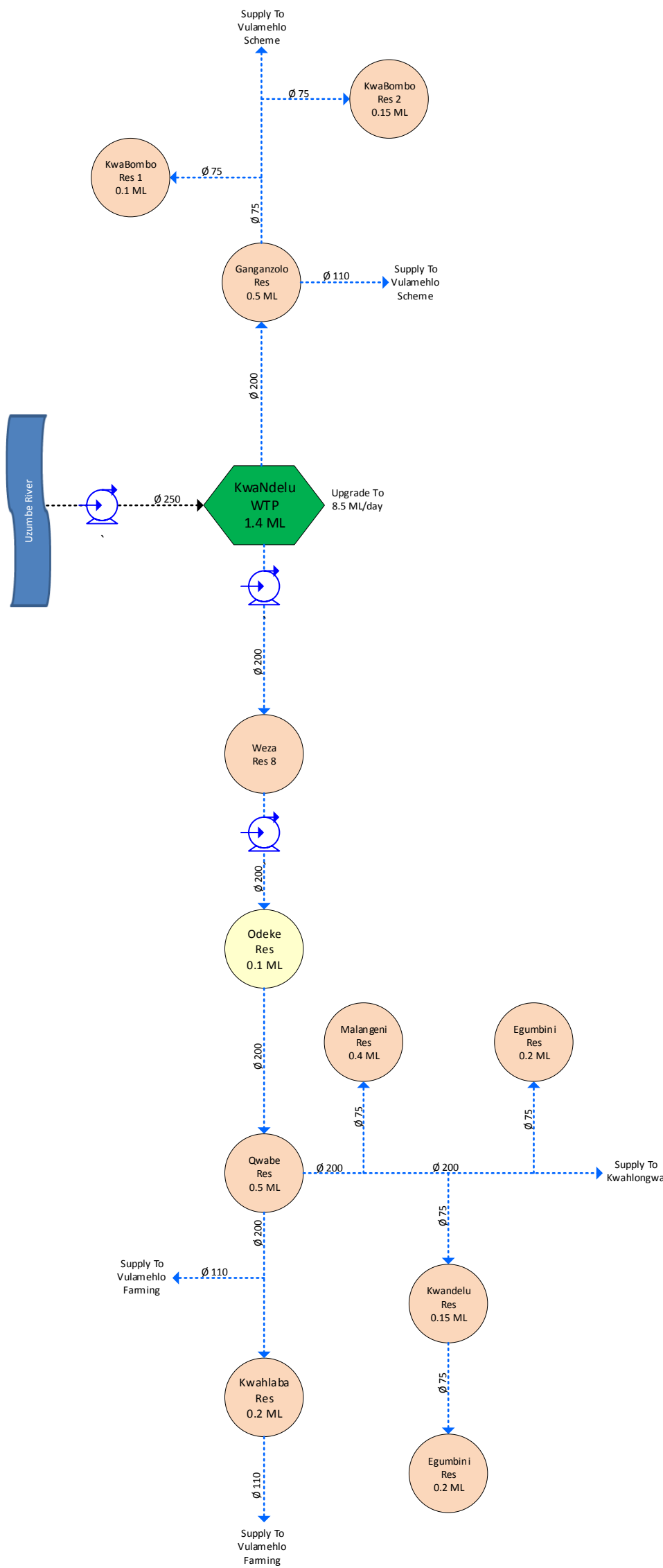

LEGEND

- Raw Water
- Clarified Water
- Treated Water**
 - Existing Primary Bulk
 - Existing Secondary Bulk
 - Existing Tertiary Bulk
 - Future Primary Bulk
 - Future Secondary Bulk
 - Future Tertiary Bulk
- Res 23 0.4 MI Existing Reservoir
- Res 24 0.92 MI Future Reservoir

All diameters in mm
 All flows in MI/day

10. CONCLUSIONS

10.1 TOTAL WATER DEMAND PER WATER SUPPLY INTERVENTION AREA (WSIA)

The total water demand per WSIA is detailed within **Table 10-1** below.

Table 10-1: Total Water Demand 2050 per WSIA

WSIA	Population 2020	Population 2050	Water Demand 2020 (Mℓ/d)	Water Demand 2050 (Mℓ/d)
uMzinto	67 413	108 288	19.14	31.47
uMtwalume	76 528	122 929	14.14	23.59
uMzimbhulu/Bhobhoyi	221 650	356 045	63.07	103.58
uMtamvuna	134 978	216 820	26.16	43.72
Harding/Weza	18 305	29 405	3.14	5.26
KwaFodo	9 368	15 048	1.64	2.76
KwaLembe	16 814	27 009	2.93	4.92
Phungashe/Mahlabatshane	64 642	103 836	10.95	18.32
KwaHlongwa	6 953	11 169	1.20	2.01
Vulamehlo Farming	12 592	20 227	2.13	3.26
Vulamehlo Scheme	7 110	11 421	1.19	1.99
Vulamehlo Cross Border	51 554	82 813	9.02	15.12
KwaMbotho	16 115	25 887	2.84	4.77
KwaNyuswa	11 142	17 898	1.93	3.24
KwaNdelu	14 907	23 946	2.50	3.80

10.2 TOTAL WATER RESOURCES REQUIRED VS PROPOSED WATER SUPPLY INTERVENTIONS (WSI)

The total volume of water required is compared to the existing proposed water supply interventions are tabled within **Table 10-2** below:

Table 10-2: Water Resources Required vs proposed WSI

WSIA	WSIA Name	Population (2050)	2050 Demand (Mℓ/day)	2050 Demand (Mm ³ /a)	Existing Resources (Mm ³ /a)	Proposed Additional under UAP Phase 3 (Mm ³ /a)	Total (Mm ³ /a)	Balance (Mm ³ /a)
UG001	uMzinto	108 288	31.47	11.49	6.64	-6.64	0.00	-11.49
UG002	uMtwalume	122 929	23.59	8.61	2.74	-2.74	0.00	-8.61
UG003	uMzimkhulu/Bhobhoyi	356 045	103.58	37.81	39.42	0.00	39.42	1.61
UG004	uMtamvuna	216 820	43.72	15.96	18.25	0.00	18.25	2.29
UG005	Harding/Weza	29 405	5.26	1.92	1.31	16.06	17.37	15.45
UG006	KwaFodo	15 048	2.76	1.01	0.00	0.00	0.00	-1.01
UG007	KwaLembe	27 009	4.92	1.80	2.19	0.00	2.19	0.39
UG008	Phungashe/Mahlabatshane	103 836	18.32	6.69	5.99	0.70	6.69	0.00
UG009	KwaHlongwa	11 169	2.01	0.73	0.00	0.00	0.00	-0.73
UG010	Vulamehlo Farming	20 227	3.26	1.19	0.00	2.28	2.28	1.10
UG011	Vulamehlo Scheme	11 421	1.99	0.73	0.51	-0.51	0.00	-0.73
UG012	Vulamehlo Cross Border	82 813	15.12	5.52	3.72	-3.72	0.00	-5.52
UG013	KwaMbotho	25 887	4.77	1.74	0.51	-0.51	0.00	-1.74
UG014	KwaNyuswa	17 898	3.24	1.18	0.09	-0.09	0.00	-1.18
UG015	KwaNdelu	23 946	3.8	1.39	0.51	-0.51	0.00	-1.39
TOTAL		1 172 741	267.81	97.75	81.89	4.32	86.21	-11.54

From **Table 10-2** above, it is noted all the schemes will have not adequate raw water resources after upgrades/interventions to meet the 2050 demand requirements. The feasibility studies for the proposed resources and, in addition, the implementation of the uMzimkhulu/Bhobhoyi Water Supply Scheme should be prioritised.

10.3 SUMMARY OF TOTAL BULK WATER INFRASTRUCTURE REQUIREMENTS PER WSIA

A summary of the total bulk water infrastructure requirements per proposed WSIA is provided within the tables and pages hereafter.

10.3.1 UG001: uMzinto WSIA

Table 10-3: WSIA Summary for the UG001: uMzinto WSIA

uMzinto Scheme						
Item	Description					
1	Infrastructure		Class	Size / No	Capacity (Mℓ/day or Length or kW)	
1.1	Existing	WTP	Various	Regional Bulk	1	13.6
		WTP	Various	Internal Bulk	0	0
		Pump Stations	Various	Regional Bulk	13	0
		Pump Stations	Various	Internal Bulk	0	0
		Bulk Pipelines	uPVC, Steel, HDPE, AC	Primary Bulk	>350	0.00
				Secondary Bulk	160 ø mm - 300 ømm	0.00
				Tertiary Bulk	50 ø mm - 110 ømm	204.79
		Reservoirs	Command Reservoir	Primary Bulk	-	-
			Command Reservoir	Secondary Bulk	8	0.68 kl to 5.25 kl
			Supply Reservoirs	Tertiary Bulk	-	-
1.2	Future	Bulk Pipelines		Primary Bulk	>350	14.8
				Secondary Bulk	160 ø mm - 300 ømm	32.6
				Tertiary Bulk	50 ø mm - 110 ømm	0
		Reservoirs	Command Reservoir	Primary Bulk	-	-
			Command Reservoir	Secondary Bulk	10	600 kl to 30000 kl
			Supply Reservoirs	Tertiary Bulk	-	-
		Primary PS	-	-	-	-

10.3.2 UG002 WSIA: uMtwalume WSIA

Table 10-4: WSIA Summary for the UG002 WSIA: uMtwalume WSIA

uMtwalume Scheme						
Item	Description					
1	Infrastructure		Class	Size / No	Capacity (Mℓ/day or Length or kW)	
1.1	Existing	WTP	Various	Regional Bulk	2	7.5
		WTP	Various	Internal Bulk	0	0
		Pump Stations	Various	Regional Bulk	5	0
		Pump Stations	Various	Internal Bulk	0	0
		Bulk Pipelines	uPVC, Steel, HDPE, AC	Primary Bulk	>350	0.00
				Secondary Bulk	160 ø mm - 300 ømm	0.00
				Tertiary Bulk	50 ø mm - 110 ømm	160.00
		Reservoirs	Command Reservoir	Primary Bulk	-	-
			Command Reservoir	Secondary Bulk	2	0.25 kl to 0.5 kl
			Supply Reservoirs	Tertiary Bulk	-	-
1.2	Future	Bulk Pipelines	Primary Bulk	>350	2.1	
			Secondary Bulk	160 ø mm - 300 ømm	25.83	
			Tertiary Bulk	50 ø mm - 110 ømm	9.36	
		Reservoirs	Command Reservoir	Primary Bulk	-	-
			Command Reservoir	Secondary Bulk	8	400 kl to 600 kl
			Supply Reservoirs	Tertiary Bulk	-	-
		Pump stations	-	-	-	-

10.3.3 UG003 WSIA: uMzimkhulu/Bhobhoji WSIA

Table 10-5: WSIA Summary for the UG003 WSIA: uMzimkhulu/Bhobhoji WSIA

uMzimkhulu/Bobhoji Scheme						
Item	Description					
1	Infrastructure		Class	Size / No	Capacity (Mℓ/day or Length or kW)	
1.1	Existing	WTP	Various	Regional Bulk	2	81
		WTP	Various	Internal Bulk	0	0
		Pump Stations	Various	Regional Bulk	20	0
		Pump Stations	Various	Internal Bulk	0	0
		Bulk Pipelines	uPVC, Steel, HDPE, AC	Primary Bulk	>350	380.88
				Secondary Bulk	160 ø mm - 300 ømm	0.00
				Tertiary Bulk	50 ø mm - 110 ømm	43.48
		Reservoirs	Command Reservoir	Primary Bulk	-	-
			Command Reservoir	Secondary Bulk	6	2.5 kl to 9.54 kl
			Supply Reservoirs	Tertiary Bulk	-	-
1.2	Future	Bulk Pipelines		Primary Bulk	>350	98.86
				Secondary Bulk	160 ø mm - 300 ømm	6.45
				Tertiary Bulk	50 ø mm - 110 ømm	0.83
		Reservoirs	Command Reservoir	Primary Bulk	-	-
			Command Reservoir	Secondary Bulk	8	500 kl to 6200 kl
			Supply Reservoirs	Tertiary Bulk	-	-
		Pump stations	Primary PS	-	-	-

10.3.4 UG004 WSIA: uMtamvuna WSIA

Table 10-6: WSIA Summary for the UG004 WSIA: uMtamvuna WSIA

uMtamvuna Scheme						
Item	Description					
1	Infrastructure		Class	Size / No	Capacity (Mℓ/day or Length or kW)	
1.1	Existing	WTP	Various	Regional Bulk	0	0
		WTP	Various	Internal Bulk	1	20
		Pump Stations	Various	Regional Bulk	12	0
		Pump Stations	Various	Internal Bulk	0	0
		Bulk Pipelines	uPVC, Steel, HDPE, AC	Primary Bulk	>350	66.29
				Secondary Bulk	160 ø mm - 300 ømm	0.00
				Tertiary Bulk	50 ø mm - 110 ømm	135.46
		Reservoirs	Command Reservoir	Primary Bulk	-	-
			Command Reservoir	Secondary Bulk	4	1 kl to 5 kl
			Supply Reservoirs	Tertiary Bulk	-	-
1.2	Future	Bulk Pipelines		Primary Bulk	>350	6.3
				Secondary Bulk	160 ø mm - 300 ømm	45.8
				Tertiary Bulk	50 ø mm - 110 ømm	0.28
		Reservoirs	Command Reservoir	Primary Bulk	-	-
			Command Reservoir	Secondary Bulk	6	200 kl to 5000 kl
			Supply Reservoirs	Tertiary Bulk	-	-
		Pump stations	Primary PS	Primary Bulk	-	90
			Secondary PS	Secondary Bulk	-	20

10.3.5 UG005 WSIA: Harding/Weza WSIA

Table 10-7: WSIA Summary for the UG005 WSIA: Harding/Weza WSIA

Harding/Weza Scheme						
Item	Description					
1	Infrastructure		Class	Size / No	Capacity (Mℓ/day or Length or kW)	
1.1	Existing	WTP	Various	Regional Bulk	3	4.8
		WTP	Various	Internal Bulk	0	0
		Pump Stations	Various	Regional Bulk	3	0
		Pump Stations	Various	Internal Bulk	0	0
		Bulk Pipelines	uPVC, Steel, HDPE, AC	Primary Bulk	>350	174.47
				Secondary Bulk	160 ø mm - 300 ømm	0.00
				Tertiary Bulk	50 ø mm - 110 ømm	30.92
		Reservoirs	Command Reservoir	Primary Bulk	-	-
			Command Reservoir	Secondary Bulk	4	0.5 kl to 11 kl
			Supply Reservoirs	Tertiary Bulk	-	-
1.2	Future	Bulk Pipelines		Primary Bulk	>350	97.4
				Secondary Bulk	160 ø mm - 300 ømm	58.5
				Tertiary Bulk	50 ø mm - 110 ømm	13.5
		Reservoirs	Command Reservoir	Primary Bulk	-	-
			Command Reservoir	Secondary Bulk	14	100 kl to 20000 kl
			Supply Reservoirs	Tertiary Bulk	-	-
		Pump stations	Primary PS	Primary Bulk	-	209

10.3.6 UG006 WSIA: KwaFodo WSIA

Table 10-8: WSIA Summary for the UG006 WSIA: KwaFodo WSIA

KwaFodo Scheme						
Item	Description					
1	Infrastructure		Class	Size / No	Capacity (Mℓ/day or Length or kW)	
1.1	Existing	WTP	Various	Regional Bulk	1	0
		WTP	Various	Internal Bulk	0	0
		Pump Stations	Various	Regional Bulk	0	0
		Pump Stations	Various	Internal Bulk	0	0
		Bulk Pipelines	uPVC, Steel, HDPE, AC	Primary Bulk	>350	0.00
				Secondary Bulk	160 ø mm - 300 ømm	0.00
				Tertiary Bulk	50 ø mm - 110 ømm	0.49
		Reservoirs	Command Reservoir	Primary Bulk	-	-
			Command Reservoir	Secondary Bulk	2	0.05 kl to 0.1 kl
			Supply Reservoirs	Tertiary Bulk	-	-
1.2	Future	Bulk Pipelines	Primary Bulk	>350	0	
			Secondary Bulk	160 ø mm - 300 ømm	1.5	
			Tertiary Bulk	50 ø mm - 110 ømm	8.5	
		Reservoirs	Command Reservoir	Primary Bulk	-	-
			Command Reservoir	Secondary Bulk	5	100 kl to 2500 kl
			Supply Reservoirs	Tertiary Bulk	-	-
		Pump stations	-	-	-	-

10.3.7 UG007 WSIA: KwaLembe WSIA

Table 10-9: WSIA Summary for the UG007 WSIA: KwaLembe WSIA

KwaLembe Scheme						
Item	Description					
1	Infrastructure		Class	Size / No	Capacity (Mℓ/day or Length or kW)	
1.1	Existing	WTP	Various	Regional Bulk	1	1.4
		WTP	Various	Internal Bulk	0	0
		Pump Stations	Various	Regional Bulk	3	0
		Pump Stations	Various	Internal Bulk	0	0
		Bulk Pipelines	uPVC, Steel, HDPE, AC	Primary Bulk	>350	0.00
				Secondary Bulk	160 ø mm - 300 ømm	0.00
				Tertiary Bulk	50 ø mm - 110 ømm	50.62
		Reservoirs	Command Reservoir	Primary Bulk	-	-
			Command Reservoir	Secondary Bulk	1	0.2 kl to 0.2 kl
			Supply Reservoirs	Tertiary Bulk	-	-
1.2	Future	Bulk Pipelines		Primary Bulk	>350	0
				Secondary Bulk	160 ø mm - 300 ømm	17.4
				Tertiary Bulk	50 ø mm - 110 ømm	7.8
		Reservoirs	Command Reservoir	Primary Bulk	-	-
			Command Reservoir	Secondary Bulk	5	400 kl to 5000 kl
			Supply Reservoirs	Tertiary Bulk	-	-
		Pump stations	Primary PS	Primary Bulk	-	271
			Secondary PS	Secondary Bulk	-	10

10.3.8 UG008 WSIA: Phungashe/Mahlabatshane WSIA

Table 10-10: WSIA Summary for the UG008 WSIA: Phungashe/Mahlabatshane WSIA

Phungashe/Mahlabatshane Scheme						
Item	Description					
1	Infrastructure		Class	Size / No	Capacity (Mℓ/day or Length or kW)	
1.1	Existing	WTP	Various	Regional Bulk	3	4.4
		WTP	Various	Internal Bulk	0	0
		Pump Stations	Various	Regional Bulk	0	0
		Pump Stations	Various	Internal Bulk	0	0
		Bulk Pipelines	uPVC, Steel, HDPE, AC	Primary Bulk	>350	173.70
				Secondary Bulk	160 ø mm - 300 ømm	0.00
				Tertiary Bulk	50 ø mm - 110 ømm	155.55
		Reservoirs	Command Reservoir	Primary Bulk	-	-
			Command Reservoir	Secondary Bulk	-	-
			Supply Reservoirs	Tertiary Bulk	-	-
1.2	Future	Bulk Pipelines		Primary Bulk	>350	0
				Secondary Bulk	160 ø mm - 300 ømm	43.92
				Tertiary Bulk	50 ø mm - 110 ømm	5.636
		Reservoirs	Command Reservoir	Primary Bulk	-	-
			Command Reservoir	Secondary Bulk	8	200 kl to 1200 kl
			Supply Reservoirs	Tertiary Bulk	-	-
		Pump stations	-	-	-	-

10.3.9 UG009 WSIA: KwaHlongwa WSIA

Table 10-11: WSIA Summary for the UG009 WSIA: KwaHlongwa WSIA

KwaHlongwa Scheme						
Item	Description					
11	Infrastructure			Class	Size / No	Capacity (Mℓ/day or Length or kW)
1.1	Existing	WTP	Various	Regional Bulk	0	0
		WTP	Various	Internal Bulk	1	1.13
		Pump Stations	Various	Regional Bulk	2	0
		Pump Stations	Various	Internal Bulk	0	0
		Bulk Pipelines	uPVC, Steel, HDPE, AC	Primary Bulk	>350	11.87
				Secondary Bulk	160 ø mm - 300 ømm	0.00
				Tertiary Bulk	50 ø mm - 110 ømm	17.98
		Reservoirs	Command Reservoir	Primary Bulk	-	-
			Command Reservoir	Secondary Bulk	1	0.1 kl to 0.1 kl
			Supply Reservoirs	Tertiary Bulk	-	-
1.2	Future	Bulk Pipelines	Primary Bulk	>350	0	
			Secondary Bulk	160 ø mm - 300 ømm	2	
			Tertiary Bulk	50 ø mm - 110 ømm	13.86	
		Reservoirs	Command Reservoir	Primary Bulk	-	-
			Command Reservoir	Secondary Bulk	9	100 kl to 200 kl
			Supply Reservoirs	Tertiary Bulk	-	-
		Pump stations	-	-	-	-

10.3.10 UG010 WSIA: Vulamehlo Farming WSIA

Table 10-12: WSIA Summary for the UG010 WSIA: Vulamehlo Farming WSIA

Vulamehlo Farming Scheme						
Item	Description					
1	Infrastructure		Class	Size / No	Capacity (Mℓ/day or Length or kW)	
1.1	Existing	WTP	Various	Regional Bulk	0	0
		WTP	Various	Internal Bulk	0	0
		Pump Stations	Various	Regional Bulk	0	0
		Pump Stations	Various	Internal Bulk	0	0
		Bulk Pipelines	uPVC, Steel, HDPE, AC	Primary Bulk	>350	0.00
				Secondary Bulk	160 ø mm - 300 ømm	0.00
				Tertiary Bulk	50 ø mm - 110 ømm	0.00
		Reservoirs	Command Reservoir	Primary Bulk	-	-
			Command Reservoir	Secondary Bulk	0	-
			Supply Reservoirs	Tertiary Bulk	-	-
1.2	Future	Bulk Pipelines		Primary Bulk	>350	0
				Secondary Bulk	160 ø mm - 300 ømm	4.89
				Tertiary Bulk	50 ø mm - 110 ømm	22.162
		Reservoirs	Command Reservoir	Primary Bulk	-	-
			Command Reservoir	Secondary Bulk	6	200 kl to 700 kl
			Supply Reservoirs	Tertiary Bulk	-	-
		Pump stations	-	-	-	-

10.3.11 UG011 WSIA: Vulamehlo Scheme WSIA

Table 10-13: WSIA Summary for the UG011 WSIA: Vulamehlo Scheme WSIA

Vulamehlo Scheme						
Item	Description					
1	Infrastructure		Class	Size / No	Capacity (Mℓ/day or Length or kW)	
1.1	Existing	WTP	Various	Regional Bulk	0	0
		WTP	Various	Internal Bulk	0	0
		Pump Stations	Various	Regional Bulk	0	0
		Pump Stations	Various	Internal Bulk	0	0
		Bulk Pipelines	uPVC, Steel, HDPE, AC	Primary Bulk	>350	0.00
				Secondary Bulk	160 ø mm - 300 ømm	0.00
				Tertiary Bulk	50 ø mm - 110 ømm	0.00
		Reservoirs	Command Reservoir	Primary Bulk	-	-
			Command Reservoir	Secondary Bulk	0	#NUM!
			Supply Reservoirs	Tertiary Bulk	-	-
1.2	Future	Bulk Pipelines	Primary Bulk	>350	0	
			Secondary Bulk	160 ø mm - 300 ømm	0	
			Tertiary Bulk	50 ø mm - 110 ømm	16.54	
		Reservoirs	Command Reservoir	Primary Bulk	-	-
			Command Reservoir	Secondary Bulk	7	100 kl to 200 kl
			Supply Reservoirs	Tertiary Bulk	-	-
		Pump stations	-	-	-	-

10.3.12 UG012 WSIA: Vulamehlo Cross Border WSIA

Table 10-14: WSIA Summary for the UG012 WSIA: Vulamehlo Cross Border WSIA

Vulamehlo Cross Border Scheme									
Item	Description			Class	Size / No	Capacity (Mℓ/day or Length or kW)			
1	Infrastructure								
		1.1	Existing	WTP	Various	Regional Bulk	0	0	
				WTP	Various	Internal Bulk	2	4.5	
				Pump Stations	Various	Regional Bulk	2	0	
				Pump Stations	Various	Internal Bulk	0	0	
				Bulk Pipelines	uPVC, Steel, HDPE, AC	Primary Bulk	>350	13.26	
						Secondary Bulk	160 ø mm - 300 ømm	0.00	
						Tertiary Bulk	50 ø mm - 110 ømm	224.70	
				Reservoirs	Command Reservoir	Primary Bulk	-	-	
					Command Reservoir	Secondary Bulk	2	0.25 kl to 50 kl	
					Supply Reservoirs	Tertiary Bulk	-	-	
					WTP	VULAMEHLO WTP (Upgrade)	Internal Bulk	-	5.5
				1.2	Future	Bulk Pipelines	Primary Bulk	>350	14.25
							Secondary Bulk	160 ø mm - 300 ømm	67.34
Tertiary Bulk	50 ø mm - 110 ømm						21.68		
Reservoirs	Command Reservoir	Primary Bulk	-			-			
	Command Reservoir	Secondary Bulk	14			200 kl to 11000 kl			
	Supply Reservoirs	Tertiary Bulk	-			-			
Pump stations	Primary PS	Primary Bulk	-			277			
	Secondary PS	Secondary Bulk	-			147			

10.3.13 UG013 WSIA: KwaMbotho WSIA

Table 10-15: WSIA Summary for the UG013 WSIA: KwaMbotho WSIA

KwaMbotho Scheme						
Item	Description					
1	Infrastructure		Class	Size / No	Capacity (Mℓ/day or Length or kW)	
1.1	Existing	WTP	Various	Regional Bulk	0	0
		WTP	Various	Internal Bulk	1	0
		Pump Stations	Various	Regional Bulk	2	0
		Pump Stations	Various	Internal Bulk	0	0
		Bulk Pipelines	uPVC, Steel, HDPE, AC	Primary Bulk	>350	0.00
				Secondary Bulk	160 ø mm - 300 ømm	0.00
				Tertiary Bulk	50 ø mm - 110 ømm	14.45
		Reservoirs	Command Reservoir	Primary Bulk	-	-
			Command Reservoir	Secondary Bulk	3	0.12 kl to 0.2 kl
			Supply Reservoirs	Tertiary Bulk	-	-
1.2	Future	Bulk Pipelines		Primary Bulk	>350	0
				Secondary Bulk	160 ø mm - 300 ømm	18.4
				Tertiary Bulk	50 ø mm - 110 ømm	13.24
		Reservoirs	Command Reservoir	Primary Bulk	-	-
			Command Reservoir	Secondary Bulk	7	250 kl to 5000 kl
			Supply Reservoirs	Tertiary Bulk	-	-
		Pump stations	-	-	-	-

10.3.14 UG014 WSIA: KwaNyuswa WSIA

Table 10-16: WSIA Summary for the UG014 WSIA: KwaNyuswa WSIA

KwaNyuswa Scheme						
Item	Description					
1	Infrastructure		Class	Size / No	Capacity (Mℓ/day or Length or kW)	
1.1	Existing	WTP	Various	Regional Bulk	1	0.25
		WTP	Various	Internal Bulk	0	0
		Pump Stations	Various	Regional Bulk	2	0
		Pump Stations	Various	Internal Bulk	0	0
		Bulk Pipelines	uPVC, Steel, HDPE, AC	Primary Bulk	>350	5.79
				Secondary Bulk	160 ø mm - 300 ømm	0.00
				Tertiary Bulk	50 ø mm - 110 ømm	0.00
		Reservoirs	Command Reservoir	Primary Bulk	-	-
			Command Reservoir	Secondary Bulk	2	0.4 kl to 0.6 kl
			Supply Reservoirs	Tertiary Bulk	-	-
1.2	Future	Bulk Pipelines		Primary Bulk	>350	0
				Secondary Bulk	160 ø mm - 300 ømm	20.66
				Tertiary Bulk	50 ø mm - 110 ømm	9.86
		Reservoirs	Command Reservoir	Primary Bulk	-	-
			Command Reservoir	Secondary Bulk	8	100 kl to 400 kl
			Supply Reservoirs	Tertiary Bulk	-	-
		Pump stations	-	-	-	-

10.3.15 UG015 WSIA: KwaNdelu WSIA

Table 10-17: WSIA Summary for the UG015 WSIA: KwaNdelu WSIA

KwaNdelu Scheme						
Item	Description					
1	Infrastructure		Class	Size / No	Capacity (Mℓ/day or Length or kW)	
1.1	Existing	WTP	Various	Regional Bulk	0	0
		WTP	Various	Internal Bulk	1	1.4
		Pump Stations	Various	Regional Bulk	3	0
		Pump Stations	Various	Internal Bulk	0	0
		Bulk Pipelines	uPVC, Steel, HDPE, AC	Primary Bulk	>350	17.49
				Secondary Bulk	160 ø mm - 300 ømm	0.00
				Tertiary Bulk	50 ø mm - 110 ømm	10.40
		Reservoirs	Command Reservoir	Primary Bulk	-	-
			Command Reservoir	Secondary Bulk	0	#NUM!
			Supply Reservoirs	Tertiary Bulk	-	-
1.2	Future	Bulk Pipelines	Primary Bulk	>350	0	
			Secondary Bulk	160 ø mm - 300 ømm	14.77	
			Tertiary Bulk	50 ø mm - 110 ømm	22.79	
		Reservoirs	Command Reservoir	Primary Bulk	-	-
			Command Reservoir	Secondary Bulk	6	100 kl to 600 kl
			Supply Reservoirs	Tertiary Bulk	-	-
		Pump stations	-	-	-	-

10.4 FINANCIAL REQUIREMENTS

The financial requirements for the provision of bulk infrastructure per WSIA based on the demand model intervention by 2050 is summarised in the **Table 10-18** below.

Table 10-18: Financial requirements

WSIA	WSIA Name	Total Cost Requirement				
		Primary	Secondary	Tertiary	10% Contingencies	Total Cost (excl VAT)
UG001	uMzinto	R74 382 331.82	R213 917 368.96	R19 638 037.19	R30 793 773.80	R338 731 511.76
UG002	uMtwalume	R11 068 218.66	R59 462 400.53	R25 004 042.22	R9 553 466.14	R105 088 127.55
UG003	uMzimkhulu/Bhobhoyi	R498 184 221.00	R73 554 946.79	R4 070 593.57	R57 580 976.14	R633 390 737.50
UG004	uMtamvuna	R152 111 998.58	R165 757 765.44	R34 401 229.91	R35 227 099.39	R387 498 093.32
UG005	Harding/Weza	R2 493 761 308.23	R236 932 425.60	R60 025 541.15	R279 071 927.50	R3 069 791 202.48
UG006	KwaFodo	-	R26 845 264.36	R3 201 297.91	R3 004 656.23	R33 051 218.49
UG007	KwaLembe	R18 483 000.00	R74 338 542.28	R17 194 560.77	R11 001 610.30	R121 017 713.35
UG008	Phungashe/Mahlabatshane	-	R78 947 429.82	R28 551 674.82	R10 749 910.46	R118 249 015.10
UG009	KwaHlongwa	-	R29 328 863.99	R4 597 878.01	R3 392 674.20	R37 319 416.19
UG010	Vulamehlo Farming	-	R26 579 465.75	R10 077 160.05	R3 665 662.58	R40 322 288.39
UG011	Vulamehlo Scheme	-	R16 786 394.92	R2 895 175.76	R1 968 157.07	R21 649 727.75
UG012	Vulamehlo Cross Border	R915 479 269.49	R199 328 659.08	R53 219 704.65	R116 802 763.32	R1 284 830 396.53
UG013	KwaMbotho	-	R60 009 428.16	R16 475 957.33	R7 648 538.55	R84 133 924.04
UG014	KwaNyuswa	-	R46 634 124.29	R20 965 950.07	R6 760 007.44	R74 360 081.79
UG015	KwaNdelu	-	R28 189 697.29	R17 179 811.03	R4 536 950.83	R49 906 459.15
Total		R4 163 470 347.78	R1 336 612 777.26	R317 498 614.44	R581 758 173.95	R6 399 339 913.39

A total estimate of approximately R 6.4 billion is required to address the total bulk water supply requirement by 2050.

10.5 FUNDING OPTIONS

The Ugu DM relies mainly on grant funding programmes to fund their water supply projects. These funding programmes are mainly MIG and WSIG. Based on all the current funding streams available to the District Municipality over the MTEF period, it will take a minimum of 30 years for the WSA to address their water supply requirements. Another funding option that the Ugu DM could consider is loan funding through the Development Bank of Southern Africa (DBSA). Special submissions to National Treasury could also be considered to create an awareness of the DM's planning and implementation readiness.

10.6 IMPLEMENTATION PROGRAMME

The implementation programme will depend on the availability of funds from National Treasury as well as the capacity of the Municipality to implement projects. Although all fifteen (15) area interventions would be an implementation priority for the DM, it is proposed to consider the following three (3) priorities detailed within **Table 10-19**. It is also proposed to follow a phased approach for implementation for e.g. initiate only the upgrade to the WTP at first and then when funding permits, can the bulk conveyance and storage be extended, upgraded or constructed.

However, the order would most likely be determined by the availability of funds or intervention programmes and should be confirmed with the WSA.

Table 10-19: Proposed Implementation Order (Phased Approach)

Proposed Priorities (Phased Approach)	WSIA No and Name	Proposed Project Name	Proposed Estimated Project Value	
1	UG003 UG008	uMzimkhulu/Bhobhoyi Phungashe/Mahlabatshane	Development of Ncwabeni OCS Dam in order to assure supply to uMzimkhulu/Bhobhoyi as well as supply to Phungashe/Mahlabatshane. Implementation of weir on Mzimkhulu River to address salination and supply.	R633 390 737.50 R118 249 015.10
2	UG004	uMtamvuna	Upgrade of supply to Southbroom to augment the uMzimkhulu/Bhobhoyi scheme	R387 498 093.32
3	UG005	Harding/Weza	Hydrological study for the Gundrift weir to determine yield to supply the Harding/Weza scheme.	R3 069 791 202.48
4	UG012	Vulamehlo Cross Border	Feasibility study to increase the yield of Vulamehlo Dam to assure of supply to the Vulamehlo and uMtwalume/uMzinto schemes.	R1 284 830 396.53
5	UG002	uMtwalume	Further supply from the South Coast Pipeline. Hydrological study on the Mtwalume River/weir to determine yield to supply the uMtamvuna scheme.	R105 088 127.55

11. RECOMMENDATIONS

11.1 RESPONSIBILITIES

The provision of water services remains the responsibility of the Ugu DM as the WSA. The Ugu DM should ensure that they meet all the requirements to take these interventions to implementation readiness.

These planning studies are in various stages of readiness to lobby for grant funding and Umgeni Water could consider this as a Regional Utility to assist the Ugu DM to take this process further.

11.2 SELECTION OF SOLUTIONS

The fifteen (15) proposed water supply intervention areas (WSIA's) are the appropriate solutions for bulk water supply development within Ugu DM and are as follows:

- ✓ UG001 WSIA: uMzinto
- ✓ UG002 WSIA: uMtwalume
- ✓ UG003 WSIA: uMzimkhulu/Bhobhoyi
- ✓ UG004 WSIA: uMtamvuna
- ✓ UG005 WSIA: Harding/Weza
- ✓ UG006 WSIA: KwaFodo
- ✓ UG007 WSIA: KwaLembe
- ✓ UG008 WSIA: Phungashe/Mahlabatshane
- ✓ UG009 WSIA: KwaHlongwa
- ✓ UG010 WSIA: Vulamehlo Farming
- ✓ UG011 WSIA: Vulamehlo Scheme
- ✓ UG012 WSIA: Vulamehlo Cross Border
- ✓ UG013 WSIA: KwaMbotho
- ✓ UG014 WSIA: KwaNyuswa
- ✓ UG015 WSIA: KwaNdelu

11.3 PERTINENT LEGISLATION

Various Acts of Parliament make provision for existing or planned institutional structures for management of water resources and water and sanitation services. These are:

- ✓ Current Acts of Parliament: National Water, Water Services, Municipal Structures, Municipal Systems, Division of Revenue Acts; and
- ✓ Existing and proposed policy documents such as The White Paper on Water Services, the Local Government White Paper and the White Paper on Municipal Service Partnerships.

These Acts deal with the management of water resources and the provision of water services. Provision for the bodies listed below is made in these acts:

- ✓ The Catchment Management Agencies (CMA's) which will be established throughout South Africa over the next three years;
- ✓ Water User Associations comprising co-operative associations of individual water users at a restricted local level;
- ✓ National Government;
- ✓ Water Service Authorities comprising District Municipalities or Local Municipalities;
- ✓ Water Boards;
- ✓ Water Service Providers;
- ✓ Provincial Government; and
- ✓ Advisory Committees.

11.3.1 Municipal Structures Act

The Municipal Structures Act (117 of 1997), which was subsequently amended by the Municipal Structure Amendment Act (33 of 2000), addresses the basis for establishing municipalities (Category A,B & C) and stipulates that Category A and C (Metropolitan and District) municipalities are WSA's and the Category B (local) municipalities can only be WSA's if authorised by the Minister of DPLG.

11.3.2 Municipal Systems Act

The Municipal Systems Act (32 of 2000) legislates internal systems and addresses the differences between the authority and the provider functions as well as alternative mechanisms for providing municipal services.

11.3.3 Water Services Act

The Water Services Act (Act 108 of 1997) states that each WSA must for its area of jurisdiction, prepare a Water Services Development Plan (WSDP). Whilst the WSDP is a legal requirement, the real value in preparing the WSDP lies in the need to plan for Water Services (Water Supply and Sanitation Provision) whereby key targets are set over the next five years. At least six WSDP key focus areas need to be addressed during the planning process. These are:

- ✓ Basic Service: Water supply, sanitation, free basic water supply and free basic sanitation;
- ✓ Higher Levels of Service: Water supply, sanitation, associated needs and economic development;
- ✓ Water Resources: Appropriate choice, demand and water conservation management, water resource protection and integrated water resource management;
- ✓ Environmental Issues: Health, natural and social environment;

-
- ✓ Effective Management: planning, organisational or institutional aspects, management, financial and regulatory aspects; and
 - ✓ Transfers: Infrastructure related transfers.

Water services development planning must also be done as part of the IDP process (section 12 (1) (a)) and the WSDP must be incorporated into the IDP (section 15 (5)).

Water Services Authorities must report on the implementation of its WSDP every year i.e. annual performance reporting (section 18).

Water Services Authorities must also comply with applicable regulations including Regulation No. R. 509, Government Gazette No. 22355, 8 June 2001 which requires the inclusion of a Water Services Audit as part of the annual performance report.

The Department must monitor the performance of every water services authority to ensure its compliance with every applicable water services development plan...section 62 (1) (c).

The Minister may- issue guidelines to water services institutions on performing their functions in terms of this Act section 73 (1) (h).

The Minister must ensure that there is a national information system on water services....to monitor the performance of water services institutions. section 68 (b) (i).

The Minister may require any...water services institution...to furnish information to be included in the national information system. section 68 (a).

Based on the above, the preparation of a WSDP is a legal requirement.

ANNEXURE A – REFERENCES

- ✓ AECOM. (2015). Water Requirements and Return Flows Report - The uMkhomazi Water Project Phase 1: Module 1: Technical Feasibility Study Raw Water.
- ✓ AECOM. (2016). Lower uMkhomazi Bulk Water Supply Scheme - Detailed Feasibility Study and Preliminary Design.
- ✓ Bigen Africa. (2016). Universal Access Plan Phase 2 – Progressive Development of a Regional Concept Plan for Ugu District Municipality.
- ✓ CS 2016. (2018). Provincial profile: KwaZulu-Natal / Statistics South Africa. Pretoria: Statistics South Africa.
- ✓ DWS. (2019, April). Data List. Retrieved from Department of Water & Sanitation: <https://www.dwa.gov.za/wsk/DefaultList.aspx?SubjectAreaID=2&DataTopicDetailID=42&DisplayTypeID=1&PerspectiveID=0&LvID=72&DataTopicID=35>
- ✓ EVN Africa. (2017). Detailed Feasibility Study: Hydrology and Design of the Dam for a Proposed New Dam: Umzimkhulu River: Umzimkhulu District Bulk Water Supply Scheme.
- ✓ EVN Africa. (2018). Umzimkhulu Bulk Regional Water Supply Scheme - Detailed Feasibility Study.
- ✓ IDP, U. (2019). Final Integrated Development Plan for Ugu District Municipality, 2019/2020.
- ✓ Khamisi Solutions. (2019). WATER CONSERVATION & DEMAND MANAGEMENT PLAN 2019 - 2023 for UGU DM.
- ✓ Macfarlane, D. (2013). Development of an Environmental Management Framework for the Ugu District: Biodiversity Assessment.
- ✓ UW IMP. (2020). Umgeni Water Infrastructure Master Plan Volume 4: South Coast System.

ANNEXURE B – DETAILED PROPOSED WSI INFRASTRUCTURE COMPONENT DETAIL

UG001 WSIA: uMzinto Scheme

The total bulk cost requirement for the uMzinto Scheme is R338 731 511.76 (excl VAT). The scheme development cost per household is approximately R 12 500.

Umzinto Scheme						
Item	Description					
1	Population	Scheme Name	Subscheme No	Population 2020	Population 2050	
		Umzinto Scheme	UGU014	67 413	108 288	
		Total		67 413	108 288	
2	Demand	Scheme Name	Subscheme No	Demand 2020	Demand 2050	
		Umzinto Scheme	UGU014	19.14	31.47	
		Total		19.14	31.47	
3	Water Resource	Source	HFY (Mm ³ /a)	HFY (Mℓ/day)	Comments	
		Mkhomazi River	-	-	Water is sourced from the Mkhomazi River	
4	Infrastructure	WTP Name	Class	Scheme Number	Capacity (Mℓ/day or Length or kW)	
4.1	Existing	WTP	UMZINTO WTP	Regional Bulk	UGU014	13.6
		Bulk Pipelines	uPVC, Steel, HDPE, AC	Primary Bulk	>350	0.00
				Secondary Bulk	160 ø mm - 300 ømm	0.00
				Tertiary Bulk	50 ø mm - 110 ømm	204.79
		Pump stations	Pungashswe 1 WPS	Regional Bulk	UGU014	0
			Sezela WPS	Regional Bulk	UGU014	0
			Hlokozi WPS	Regional Bulk	UGU014	0
			Umdoni WPS	Regional Bulk	UGU014	0
			Malangeni WPS	Regional Bulk	UGU014	0
			B WPS	Regional Bulk	UGU014	0
			Esparanza 2 WPS	Regional Bulk	UGU014	0
			Esparanza WPS	Regional Bulk	UGU014	0
			WPS	Regional Bulk	UGU014	0
			ST Patricks WPS	Regional Bulk	UGU014	0
			Scottsburgh no 2/Raymond avenue WWPS	Regional Bulk	UGU014	0
			Hospital WPS	Regional Bulk	UGU014	0
			Gandinagar WPS	Regional Bulk	UGU014	0
Reservoirs	Scottsburgh Reservoir	Secondary Bulk	1	2.71		
	Cabana Sand Reservoir	Secondary Bulk	1	1.00		

			Scottburg South Reservoir 2	Secondary Bulk	1	5.25
			Ellingham Reservoir	Secondary Bulk	1	2.00
			Ifafa Mission Reservoir	Secondary Bulk	1	1.00
			Umzinto Heights Reservoir	Secondary Bulk	1	5.00
			Hazlewood Reservoir	Secondary Bulk	1	0.68
			Nkonka Reservoir	Secondary Bulk	1	5.00
4.2	Future	Bulk Pipelines	uPVC, Steel, HDPE, AC	Primary Bulk	>350	14.8
				Secondary Bulk	160 ø mm - 300 ømm	32.6
				Tertiary Bulk	50 ø mm - 110 ømm	0
		Reservoirs	Reservoir	Secondary Bulk	1	30000
			Reservoir	Secondary Bulk	1	12000
			Reservoir	Secondary Bulk	1	6000
			Reservoir	Secondary Bulk	1	3500
			Reservoir	Secondary Bulk	1	2200
			Reservoir	Secondary Bulk	1	1250
			Reservoir	Secondary Bulk	1	1000
			Reservoir	Secondary Bulk	1	600
			Reservoir	Secondary Bulk	2	500
		Pump stations	Primary PS	-	-	-
5	Cost Requirement		Capital Cost	10% Contingencies	Total Cost (Excl VAT)	
		Primary Bulk	R74 382 331.82	R7 438 233.18	R81 820 565.00	
		Secondary Bulk	R213 917 368.96	R21 391 736.90	R235 309 105.86	
		Tertiary Bulk	R19 638 037.19	R1 963 803.72	R21 601 840.91	
		Total	R307 937 737.97	R30 793 773.80	R338 731 511.76	

UG002 WSIA: uMtwalume Scheme

The total bulk cost requirement for the uMtwalume Scheme is R105 088 127.55 (excl VAT). The scheme development cost per household is approximately R 3 400.

uMtwalume Scheme						
Item	Description					
1	Population	Scheme Name	Subscheme No	Population 2020	Population 2050	
		Mtwalume Scheme	UGU011	76 528	122 929	
		Total		76 528	122 929	
2	Demand	Scheme Name	Subscheme No	Demand 2020	Demand 2050	
		Mtwalume Scheme	UGU011	14.87	24.79	
		Total		14.87	24.79	
3	Water Resource	Source	HFY (Mm ³ /a)	HFY (Mℓ/day)	Comments	
		Mtwalume River	1.2045	3.3	Water is sourced from the Mtwalume River	
4	Infrastructure	WTP Name	Class	Scheme Number	Capacity (Mℓ/day or Length or kW)	
4.1	Existing	WTP	MTWALUME WTP	Regional Bulk	UGU011	7.5
		Bulk Pipelines	uPVC, Steel, HDPE, AC	Primary Bulk	>350	0.00
				Secondary Bulk	160 ø mm - 300 ømm	0.00
				Tertiary Bulk	50 ø mm - 110 ømm	160.00
		Pump stations	Kwa Hlongwa WPS	Regional Bulk	UGU011	0
			Ixobho WPS	Regional Bulk	UGU011	0
			Mnamfu A WPS	Regional Bulk	UGU011	0
			Mnamfu B WPS	Regional Bulk	UGU011	0
		Reservoirs	Koelwaters WPS	Regional Bulk	UGU011	0
			Mathulini Reservoir phase 2	Secondary Bulk	1	0.50
Mtwalume Reservoir/Long beach water	Secondary Bulk	1	0.25			
4.2	Future	Bulk Pipelines	uPVC, Steel, HDPE, AC	Primary Bulk	>350	2.1
				Secondary Bulk	160 ø mm - 300 ømm	25.83
				Tertiary Bulk	50 ø mm - 110 ømm	9.36
		Reservoirs	Reservoir	Secondary Bulk	1	2000
			Reservoir	Secondary Bulk	2	600
			Reservoir	Secondary Bulk	2	500
			Reservoir	Secondary Bulk	1	400
			Reservoir	Secondary Bulk	2	300

		Pump stations	-	-	-	-
5	Cost Requirement		Capital Cost	10% Contingencies	Total Cost (Excl VAT)	
		Primary Bulk	R11 068 218.66	R1 106 821.87	R12 175 040.53	
		Secondary Bulk	R59 462 400.53	R5 946 240.05	R65 408 640.59	
		Tertiary Bulk	R25 004 042.22	R2 500 404.22	R27 504 446.44	
		Total	R95 534 661.41	R9 553 466.14	R105 088 127.55	

UG003 WSIA: uMzimkhulu/Bhobhoi Scheme

The total bulk cost requirement for the uMzimkhulu/Bhobhoi Scheme is R633 390 737.50 (excl VAT). The scheme development cost per household is approximately R 10 500.

Umzimzimkulu/Boboyi Scheme						
Item	Description					
1	Population	Scheme Name	Subscheme No	Population 2020	Population 2050	
		Umzimzimkulu/Boboyi Scheme	UGU012	224 213	360 162	
		Total		224 213	360 162	
2	Demand	Scheme Name	Subscheme No	Demand 2020	Demand 2050	
		Umzimzimkulu/Boboyi Scheme	UGU012	63.71	104.63	
		Total		63.71	104.63	
3	Water Resource	Source	HFY (Mm³/a)	HFY (Mℓ/day)	Comments	
		Umzimzimkulu River	18.3	50.1	Water is sourced from the Umzimzimkulu River	
4	Infrastructure		WTP Name	Class	Scheme Number	
4.1	Existing	WTP	UMZIMKHULU/BHO BHOYI WTP	Regional Bulk	UGU012	81
			KWANYUSWA WTP 2	Regional Bulk	UGU012	0
		Bulk Pipelines	uPVC, Steel, HDPE, AC	Primary Bulk	>350	380.88
				Secondary Bulk	160 ø mm - 300 ømm	0.00
				Tertiary Bulk	50 ø mm - 110 ømm	43.48
		Pump stations	Hanover WPS	Regional Bulk	UGU012	0
			Ramsgate Tidal Pool WWPS	Regional Bulk	UGU012	0
			Florida WPS	Regional Bulk	UGU012	0
			Nodelane(KaDlovunga) WPS	Regional Bulk	UGU012	0
			St Michaels golf/Knoxgore rd WWPS	Regional Bulk	UGU012	0
			Nkulu WPS	Regional Bulk	UGU012	0
			Izotsha WPS	Regional Bulk	UGU012	0
			<Null>	Regional Bulk	UGU012	0
			Bomela WPS	Regional Bulk	UGU012	0
			Masinege Res 1 Tower WPS	Regional Bulk	UGU012	0
Esperanza WPS	Regional Bulk		UGU012	0		
Nsimini WPS	Regional Bulk		UGU012	0		
<Null>	Regional Bulk	UGU012	0			

			Gamalakhe WPS	Regional Bulk	UGU012	0	
			Umzimkulu River Abstraction WPS	Regional Bulk	UGU012	0	
			Kwanyaswa NEW Phase 3 WPS	Regional Bulk	UGU012	0	
			St Martins WPS	Regional Bulk	UGU012	0	
			Jali WPS	Regional Bulk	UGU012	0	
			Ikwezi WPS	Regional Bulk	UGU012	0	
			Fairview WPS	Regional Bulk	UGU012	0	
		Reservoirs	Catalina Reservoir	Secondary Bulk	1	2.50	
			Anerly Reservoir	Secondary Bulk	1	2.50	
			Gamalakhe reservoir and pump	Secondary Bulk	0	0.00	
			Nositha reservoir	Secondary Bulk	1	2.50	
			Sea slope reservoir and pump no.1	Secondary Bulk	1	9.54	
			Sea slope reservoir no.3	Secondary Bulk	0	0.00	
			Sea slope reservoir no.4	Secondary Bulk	0	0.00	
			Shelly beach reservoir	Secondary Bulk	1	7.30	
			Murchison reservoir no.2	Secondary Bulk	0	0.00	
			Murchison reservoir no.3	Secondary Bulk	0	0.00	
			Murchison reservoir no.4	Secondary Bulk	0	0.00	
			Woodgrange	Secondary Bulk	0	0.00	
			Melville	Secondary Bulk	1	4.50	
			Stick Farm	Secondary Bulk	0	0.00	
4.2	Future		Bulk Pipelines		Primary Bulk	>350	98.86
				Secondary Bulk	160 ø mm - 300 ømm	6.45	
				Tertiary Bulk	50 ø mm - 110 ømm	0.83	
			Reservoirs	Reservoir	Secondary Bulk	1	6200
				Reservoir	Secondary Bulk	1	2900
				Reservoir	Secondary Bulk	2	1500
				Reservoir	Secondary Bulk	1	1400
				Reservoir	Secondary Bulk	1	1000
				Reservoir	Secondary Bulk	1	500
				Reservoir	Secondary Bulk	1	400
	Pump stations	Primary PS	-	-	-		
5	Cost Requirement		Capital Cost	10% Contingencies	Total Cost (Excl VAT)		
			Primary Bulk	R498 184 221.00	R49 818 422.10	R548 002 643.10	
			Secondary Bulk	R73 554 946.79	R7 355 494.68	R80 910 441.47	
			Tertiary Bulk	R4 070 593.57	R407 059.36	R4 477 652.93	

		Total	R575 809 761.36	R57 580 976.14	R633 390 737.50	
--	--	--------------	------------------------	-----------------------	------------------------	--

UG004 WSIA: uMtamvuna Scheme

The total bulk cost requirement for the uMtamvuna Scheme is R387 498 093.32 (excl VAT). The scheme development cost per household is approximately R 10 700.

Mtavuna Scheme						
Item	Description					
1	Population	Scheme Name	Subscheme No	Population 2020	Population 2050	
		Mtavuna Scheme	UGU010	134 978	216 820	
		Total		134 978	216 820	
2	Demand	Scheme Name	Subscheme No	Demand 2020	Demand 2050	
		Mtavuna Scheme	UGU010	26.16	43.72	
		Total		26.16	43.72	
3	Water Resource	Source	HFY (Mm3/a)	HFY (MI/d)	Comments	
		Mtavuna River	-	-	Water is sourced from the Mtavuna River	
4	Infrastructure		WTP Name	Class	Scheme Number	Capacity (MI/d or Length or kW)
4.1	Existing	WTP	UMTAMVUNA WTP	Internal Bulk	UGU010	20
		Bulk Pipelines	uPVC, Steel, HDPE, AC	Primary Bulk	>350	66.29
				Secondary Bulk	160 ø mm - 300 ømm	0.00
				Tertiary Bulk	50 ø mm - 110 ømm	135.46
		Pump stations	Banners Rest	Regional Bulk	UGU010	0
			WPS	Regional Bulk	UGU010	0
			Nzimakwe WPS	Regional Bulk	UGU010	0
			Travalgar WWPS	Regional Bulk	UGU010	0
			Booster WPS	Regional Bulk	UGU010	0
			Umtamvuna WPS	Regional Bulk	UGU010	0
			Fascadale WPS	Regional Bulk	UGU010	0
			Nova Estates Booster WPS	Regional Bulk	UGU010	0
			Shoba WPS	Regional Bulk	UGU010	0
			Gamalakhe 1& 2 WPS	Regional Bulk	UGU010	0
			Shobeni Tower WPS	Regional Bulk	UGU010	0
		Shobeni (Embeni) WPS	Regional Bulk	UGU010	0	
		Reservoirs	Mthavuna Reservoir	Secondary Bulk	0	0.00
Mpenjathi Reservoir	Secondary Bulk		0	0.00		
Trafalgar Reservoir	Secondary Bulk		0	0.00		

			MARINE BEACH RESERVOIR	Secondary Bulk	0	0.00
			Banners Rest	Secondary Bulk	1	1.00
			EBENEZER RESERVOIR	Secondary Bulk	0	0.00
			EBENEZER RESERVOIR	Secondary Bulk	0	0.00
			PORT EDWARD	Secondary Bulk	0	0.00
			GLENMORE RESERVOIR	Secondary Bulk	0	0.00
			LEASURE	Secondary Bulk	1	2.50
			BP 2 reservoir	Secondary Bulk	1	5.00
			BP 1 Reservoir	Secondary Bulk	1	5.00
			Unknown	Secondary Bulk	0	0.00
			Unknown	Secondary Bulk	0	0.00
4.2	Future	Bulk Pipelines	uPVC, Steel, HDPE, AC	Primary Bulk	>350	16.8
				Secondary Bulk	160 ø mm - 300 ømm	45.8
				Tertiary Bulk	50 ø mm - 110 ømm	0.28
		Reservoirs	Reservoir	Secondary Bulk	1	8000
			Reservoir	Secondary Bulk	1	5000
			Reservoir	Secondary Bulk	1	1400
			Reservoir	Secondary Bulk	1	1200
			Reservoir	Secondary Bulk	2	650
			Reservoir	Secondary Bulk	1	200
		Pump stations	Primary PS	Primary Bulk	-	90
			Secondary PS	Secondary Bulk	-	20
5	Cost Requirement		Capital Cost	10% Contingencies	Total Cost (Excl VAT)	
		Primary Bulk	R152 111 998.58	R15 211 199.86	R167 323 198.44	
		Secondary Bulk	R165 757 765.44	R16 575 776.54	R182 333 541.98	
		Tertiary Bulk	R34 401 229.91	R3 440 122.99	R37 841 352.90	
		Total	R352 270 993.93	R35 227 099.39	R387 498 093.32	

UG005 WSIA: Harding/Weza Scheme

The total bulk cost requirement for the Harding/Weza Scheme is R3 069 791 202.48 (excl VAT). The scheme development cost per household is approximately R 98 000.

Harding/Weza Scheme							
Item	Description						
1	Population	Scheme Name	Subscheme No	Population 2020	Population 2050		
		Harding/Weza Scheme	UGU001	117 433	188 638		
		Total		117 433	188 638		
2	Demand	Scheme Name	Subscheme No	Demand 2020	Demand 2050		
		Harding/Weza Scheme	UGU001	22.14	36.97		
		Total		22.14	36.97		
3	Water Resource	Source	HFY (Mm ³ /a)	HFY (MI/d)	Comments		
		Weza River and Proposed Dam 6	9.2	25.2	Water is sourced from the Weza River and Proposed Dam 6		
4	Infrastructure		WTP Name	Class	Scheme Number		
4.1	Existing	WTP	WEZA WTP	Regional Bulk	UGU001	3.6	
			HARDING WTP	Regional Bulk	UGU001	1.2	
		Bulk Pipelines	uPVC, Steel, HDPE, AC	Primary Bulk	>350	174.47	
				Secondary Bulk	160 ø mm - 300 ømm	0.00	
				Tertiary Bulk	50 ø mm - 110 ømm	30.92	
		Pump stations		Madlala WPS	Regional Bulk	UGU001	0
				Domba WPS	Regional Bulk	UGU001	0
				Woodgrange WPS	Regional Bulk	UGU001	0
		Reservoirs		Mlozale Reservoir	Secondary Bulk	1	0.50
				Elim Reservoir	Secondary Bulk	1	5.50
				KwaMachi Reservoir	Secondary Bulk	1	1.00
				Khwezi res	Secondary Bulk	0	0.00
				Khwezi res	Secondary Bulk	1	11.00
				Harding res	Secondary Bulk	0	0.00
4.2	Future	WTP	WEZA WTP	Regional Bulk	UGU001	10	
			HARDING WTP	Regional Bulk	UGU001	18	
		Bulk Pipelines	uPVC, Steel, HDPE, AC	Primary Bulk	>350	97.4	
				Secondary Bulk	160 ø mm - 300 ømm	58.5	
				Tertiary Bulk	50 ø mm - 110 ømm	13.5	

		Reservoirs	Reservoir	Secondary Bulk	1	25000
			Reservoir	Secondary Bulk	1	20000
			Reservoir	Secondary Bulk	1	10000
			Reservoir	Secondary Bulk	1	5000
			Reservoir	Secondary Bulk	1	3000
			Reservoir	Secondary Bulk	1	2000
			Reservoir	Secondary Bulk	4	1000
			Reservoir	Secondary Bulk	2	500
			Reservoir	Secondary Bulk	2	200
			Reservoir	Secondary Bulk	1	100
			Pump stations	Primary PS	Primary Bulk	-
5	Cost Requirement		Capital Cost	10% Contingencies	Total Cost (Excl VAT)	
		Primary Bulk	R2 493 761 308.23	R249 376 130.82	R2 743 137 439.05	
		Secondary Bulk	R236 932 425.60	R23 693 242.56	R260 625 668.16	
		Tertiary Bulk	R60 025 541.15	R6 002 554.12	R66 028 095.27	
		Total	R2 790 719 274.98	R279 071 927.50	R3 069 791 202.48	

UG006 WSIA: KwaFodo Scheme

The total bulk cost requirement for the KwaFodo Scheme is R33 051 218.49 (excl VAT). The scheme development cost per household is approximately R 8 800.

KwaFodo Scheme							
Item	Description						
1	Population	Scheme Name	Subscheme No	Population 2020	Population 2050		
		Kwa-Fodo Scheme	UGU002	9 368	15 048		
		Total		9 368	15 048		
2	Demand	Scheme Name	Subscheme No	Demand 2020	Demand 2050		
		Kwa-Fodo Scheme	UGU002	1.64	2.76		
		Total		1.64	2.76		
3	Water Resource	Source	HFY (Mm ³ /a)	HFY (Mℓ/day)	Comments		
		Cekeza River	-	-	Water is sourced from the Cekeza River		
4	Infrastructure		WTP Name	Class	Scheme Number	Capacity (Mℓ/day or Length or kW)	
4.1	Existing	WTP	KWAFODO WTP	Regional Bulk	UGU002	0	
		Bulk Pipelines	uPVC, Steel, HDPE, AC	Primary Bulk	>350	0.00	
				Secondary Bulk	160 ø mm - 300 ømm	0.00	
				Tertiary Bulk	50 ø mm - 110 ømm	0.49	
		Pump stations					
		Reservoirs	Santombe KwaFodo South Reservoir (A)	Secondary Bulk	0	0.00	
			KwaFodo South reservoir (C)	Secondary Bulk	1	0.05	
			KwaFodo South reservoir (F)	Secondary Bulk	0	0.00	
			KwaFodo South Reservoir (E)	Secondary Bulk	0	0.00	
			KwaFodo South Reservoir (D)	Secondary Bulk	0	0.00	
Santomba Reservoir (A)	Secondary Bulk	1	0.10				
4.2	Future	Bulk Pipelines	uPVC, Steel, HDPE, AC	Primary Bulk	>350	0	
				Secondary Bulk	160 ø mm - 300 ømm	1.5	
				Tertiary Bulk	50 ø mm - 110 ømm	8.5	
		Reservoirs	Reservoir	Secondary Bulk	1	2500	
			Reservoir	Secondary Bulk	1	900	
			Reservoir	Secondary Bulk	1	700	
			Reservoir	Secondary Bulk	1	500	
			Reservoir	Secondary Bulk	1	100	

		Pump stations	-	-	-	-
5	Cost Requirement		Capital Cost	10% Contingencies	Total Cost (Excl VAT)	
		Primary Bulk	R0.00	R0.00	R0.00	
		Secondary Bulk	R26 845 264.36	R2 684 526.44	R29 529 790.79	
		Tertiary Bulk	R3 201 297.91	R320 129.79	R3 521 427.70	
		Total	R30 046 562.26	R3 004 656.23	R33 051 218.49	

UG007 WSIA: KwaLembe Scheme

The total bulk cost requirement for the KwaLembe Scheme is R121 017 713.35 (excl VAT). The scheme development cost per household is approximately R 18 000.

KwaLembe Scheme						
Item	Description					
1	Population	Scheme Name	Subscheme No	Population 2020	Population 2050	
		Kwalembe Scheme	UGU005	16 814	27 009	
		Total		16 814	27 009	
2	Demand	Scheme Name	Subscheme No	Demand 2020	Demand 2050	
		Kwalembe Scheme	UGU005	2.93	4.92	
		Total		2.93	4.92	
3	Water Resource	Source	HFY (Mm ³ /a)	HFY (Mℓ/day)	Comments	
		Mkhomazi River	-	-	Water is sourced from the Mkhomazi River	
4	Infrastructure	WTP Name	Class	Scheme Number	Capacity (Mℓ/day or Length or kW)	
4.1	Existing	WTP	KWALEMBE WTP	Regional Bulk	UGU005	1.4
		Bulk Pipelines	uPVC, Steel, HDPE, AC	Primary Bulk	>350	0.00
				Secondary Bulk	160 ø mm - 300 ømm	0.00
				Tertiary Bulk	50 ø mm - 110 ømm	50.62
		Pump stations	R1 WPS	Regional Bulk	UGU005	0
			Kwaqiko/Indunduma WPS	Regional Bulk	UGU005	0
			Ensthaseni /booster PS 1 WPS	Regional Bulk	UGU005	0
		Reservoirs	KwaQiko Reservoir no.1/ Plant	Secondary Bulk	1	0.20
			KwaQiko Reservoir no.2	Secondary Bulk	0	0.00
			Unknown	Secondary Bulk	0	0.00
4.2	Future	Bulk Pipelines	uPVC, Steel, HDPE, AC	Primary Bulk	>350	0
				Secondary Bulk	160 ø mm - 300 ømm	17.4
				Tertiary Bulk	50 ø mm - 110 ømm	7.8
		Reservoirs	Reservoir	Secondary Bulk	1	5000
			Reservoir	Secondary Bulk	1	4500
			Reservoir	Secondary Bulk	1	1600
			Reservoir	Secondary Bulk	1	600
			Reservoir	Secondary Bulk	1	400
		Primary PS	Primary Bulk	-	271	

		Pump stations	Secondary PS	Secondary Bulk	-	10
5	Cost Requirement		Capital Cost	10% Contingencies	Total Cost (Excl VAT)	
		Primary Bulk	R18 483 000.00	R1 848 300.00	R20 331 300.00	
		Secondary Bulk	R74 338 542.28	R7 433 854.23	R81 772 396.50	
		Tertiary Bulk	R17 194 560.77	R1 719 456.08	R18 914 016.84	
		Total	R110 016 103.04	R11 001 610.30	R121 017 713.35	

UG008 WSIA: Phungashe/Mahlabatshane Scheme

The total bulk cost requirement for the Phungashe/Mahlabatshane Scheme is R118 249 015.10 (excl VAT).
The scheme development cost per household is approximately R 4 500.

Phungashe/Mahlabatshane Scheme						
Item	Description					
1	Population	Scheme Name	Subscheme No	Population 2020	Population 2050	
		Phungashe/Mahlabatshane Scheme	UGU007	64 642	103 836	
		Total		64 642	103 836	
2	Demand	Scheme Name	Subscheme No	Demand 2020	Demand 2050	
		Phungashe/Mahlabatshane Scheme	UGU007	10.95	18.32	
		Total		10.95	18.32	
3	Water Resource	Source	HFY (Mm³/a)	HFY (Mℓ/day)	Comments	
		Mahlabatshane Dam	1.606	4.4	Water is sourced from the Mahlabatshane Dam	
4	Infrastructure		WTP Name	Class	Scheme Number	Capacity (Mℓ/day or Length or kW)
4.1	Existing	WTP	PUNGASHE/MHLABATSHANE WTP	Regional Bulk	UGU007	4.4
		Bulk Pipelines	uPVC, Steel, HDPE, AC	Primary Bulk	>350	173.70
				Secondary Bulk	160 ø mm - 300 ømm	0.00
				Tertiary Bulk	50 ø mm - 110 ømm	155.55
		Pump stations	-	-	-	-
		Reservoirs	KwaCele Reservoir no.1	Secondary Bulk	0	0.00
			KwaCele Reservoir no.2	Secondary Bulk	0	0.00
			KwaCele Reservoir no.3	Secondary Bulk	0	0.00
			Mahlongwa Reservoir no.1	Secondary Bulk	0	0.00
			Amandawe Reservoir	Secondary Bulk	0	0.00
4.2	Future	Bulk Pipelines	uPVC, Steel, HDPE, AC	Primary Bulk	>350	0
				Secondary Bulk	160 ø mm - 300 ømm	43.92
				Tertiary Bulk	50 ø mm - 110 ømm	5.636
		Reservoirs	Reservoir	Secondary Bulk	1	2000
			Reservoir	Secondary Bulk	1	1600
			Reservoir	Secondary Bulk	1	1300
			Reservoir	Secondary Bulk	1	1100
			Reservoir	Secondary Bulk	1	300

			Reservoir	Secondary Bulk	1	200
			Reservoir	Secondary Bulk	2	1200
		Pump stations	-	-	-	-
5	Cost Requirement		Capital Cost	10% Contingencies	Total Cost (Excl VAT)	
		Primary Bulk	R0.00	R0.00	R0.00	
		Secondary Bulk	R78 947 429.82	R7 894 742.98	R86 842 172.80	
		Tertiary Bulk	R28 551 674.82	R2 855 167.48	R31 406 842.30	
		Total	R107 499 104.63	R10 749 910.46	R118 249 015.10	

UG009 WSIA: KwaHlongwa Scheme

The total bulk cost requirement for the KwaHlongwa Scheme is R37 319 416.19 (excl VAT). The scheme development cost per household is approximately R 13 400.

Kwahlongwa Scheme							
Item	Description						
1	Population	Scheme Name	Subscheme No	Population 2020	Population 2050		
		Kwahlongwa Scheme	UGU018	6 953	11 169		
		Total		6 953	11 169		
2	Demand	Scheme Name	Subscheme No	Demand 2020	Demand 2050		
		Kwahlongwa Scheme	UGU018	1.20	2.01		
		Total		1.20	2.01		
3	Water Resource	Source	HFY (Mm3/a)	HFY (Mℓ/day)	Comments		
		Malukaka River	-	-	Water is sourced from the Malukaka River		
4	Infrastructure		WTP Name	Class	Scheme Number	Capacity (Mℓ/day or Length or kW)	
4.1	Existing	WTP	KWAHLONGWA WTP	Internal Bulk	UGU018	1.13	
		Bulk Pipelines	uPVC, Steel, HDPE, AC	Primary Bulk	>350	11.87	
				Secondary Bulk	160 ø mm - 300 ømm	0.00	
				Tertiary Bulk	50 ø mm - 110 ømm	17.98	
				Pump stations	WPS	Regional Bulk	UGU018
		Reservoirs	Kwahlongwa 2 WPS	Regional Bulk	UGU018	0	
				Umgubo Reservoir	Secondary Bulk	1	0.10
				Unknown	Secondary Bulk	0	0.00
		Unknown	Secondary Bulk	0	0.00		
4.2	Future	Bulk Pipelines	uPVC, Steel, HDPE, AC	Primary Bulk	>350	0	
				Secondary Bulk	160 ø mm - 300 ømm	2	
				Tertiary Bulk	50 ø mm - 110 ømm	13.86	
		Reservoirs	Reservoir	Secondary Bulk	1	1200	
			Reservoir	Secondary Bulk	1	900	
			Reservoir	Secondary Bulk	2	500	
			Reservoir	Secondary Bulk	4	200	
			Reservoir	Secondary Bulk	1	100	
Pump stations	-	-	-	-			
5			Capital Cost	10% Contingencies	Total Cost (Excl VAT)		

Cost Requirement	Primary Bulk	R0.00	R0.00	R0.00
	Secondary Bulk	R29 328 863.99	R2 932 886.40	R32 261 750.39
	Tertiary Bulk	R4 597 878.01	R459 787.80	R5 057 665.81
	Total	R33 926 742.00	R3 392 674.20	R37 319 416.19

UG010 WSIA: Vulamehlo Farming Scheme

The total bulk cost requirement for the Vulamehlo Farming Scheme is R40 322 288.39 (excl VAT). The scheme development cost per household is approximately R 4 600.

Vulamehlo Farming Scheme						
Item	Description					
1	Population	Scheme Name	Subscheme No	Population 2020	Population 2050	
		Vulamehlo Farming Scheme	UGU015	21 788	34 999	
		Total		21 788	34 999	
2	Demand	Scheme Name	Subscheme No	Demand 2020	Demand 2050	
		Vulamehlo Farming Scheme	UGU015	3.75	6.27	
		Total		3.75	6.27	
3	Water Resource	Source	HFY (Mm ³ /a)	HFY (Mℓ/day)	Comments	
		Ndelu River	1.606	4.4	Water is sourced from the Ndelu River	
4	Infrastructure	WTP Name	Class	Scheme Number	Capacity (Mℓ/day or Length or kW)	
4.1	Existing	WTP	-	-	-	-
		Bulk Pipelines	uPVC, Steel, HDPE, AC	Primary Bulk	>350	0.00
				Secondary Bulk	160 ø mm - 300 ømm	0.00
				Tertiary Bulk	50 ø mm - 110 ømm	0.00
		Pump stations	-	-	-	-
Reservoirs	-	-	-	-		
4.2	Future	Bulk Pipelines	uPVC, Steel, HDPE, AC	Primary Bulk	>350	0
				Secondary Bulk	160 ø mm - 300 ømm	4.89
				Tertiary Bulk	50 ø mm - 110 ømm	22.162
		Reservoirs	Reservoir	Secondary Bulk	1	700
			Reservoir	Secondary Bulk	1	650
			Reservoir	Secondary Bulk	1	600
			Reservoir	Secondary Bulk	1	350
			Reservoir	Secondary Bulk	1	250
			Reservoir	Secondary Bulk	1	200
		Pump stations	-	-	-	-
5	Cost Requirement	Capital Cost	10% Contingencies	Total Cost (Excl VAT)		
		Primary Bulk	R0.00	R0.00	R0.00	
		Secondary Bulk	R26 579 465.75	R2 657 946.58	R29 237 412.33	

		Tertiary Bulk	R10 077 160.05	R1 007 716.01	R11 084 876.06	
		Total	R36 656 625.81	R3 665 662.58	R40 322 288.39	

UG011 WSIA: Vulamehlo Scheme

The total bulk cost requirement for the Vulamehlo Scheme is R21 649 727.75 (excl VAT). The scheme development cost per household is approximately R 7 600.

Vulamehlo Scheme						
Item	Description					
1	Population	Scheme Name	Subscheme No	Population 2020	Population 2050	
		Vulamehlo Scheme	UGU017	7 110	11 422	
		Total		7 110	11 422	
2	Demand	Scheme Name	Subscheme No	Demand 2020	Demand 2050	
		Vulamehlo Scheme	UGU017	1.19	1.99	
		Total		1.19	1.99	
3	Water Resource	Source	HFY (Mm3/a)	HFY (Mℓ/day)	Comments	
		Ndelu River	1.606	4.4	Water is sourced from the Ndelu River	
4	Infrastructure	WTP Name	Class	Scheme Number	Capacity (Mℓ/day or Length or kW)	
4.1	Existing	WTP	-	-	-	-
		Bulk Pipelines	uPVC, Steel, HDPE, AC	Primary Bulk	>350	0.00
				Secondary Bulk	160 ø mm - 300 ømm	0.00
				Tertiary Bulk	50 ø mm - 110 ømm	0.00
		Pump stations	-	-	-	-
Reservoirs	-	-	-	-		
4.2	Future	Bulk Pipelines	uPVC, Steel, HDPE, AC	Primary Bulk	>350	0
				Secondary Bulk	160 ø mm - 300 ømm	0
				Tertiary Bulk	50 ø mm - 110 ømm	16.54
		Reservoirs	Reservoir	Secondary Bulk	1	500
			Reservoir	Secondary Bulk	1	300
			Reservoir	Secondary Bulk	2	200
			Reservoir	Secondary Bulk	3	100
Pump stations	-	-	-	-		
5	Cost Requirement		Capital Cost	10% Contingencies	Total Cost (Excl VAT)	
		Primary Bulk	R0.00	R0.00	R0.00	
		Secondary Bulk	R16 786 394.92	R1 678 639.49	R18 465 034.41	
		Tertiary Bulk	R2 895 175.76	R289 517.58	R3 184 693.34	
		Total	R19 681 570.68	R1 968 157.07	R21 649 727.75	

UG012 WSIA: Vulamehlo Cross Border Scheme

The total bulk cost requirement for the Vulamehlo Cross Border Scheme is R1 284 830 396.53 (excl VAT).

The scheme development cost per household is approximately R 62 000.

Vulamehlo Cross Border Scheme						
Item	Description					
1	Population	Scheme Name	Subscheme No	Population 2020	Population 2050	
		Vulamehlo Cross Border Scheme	UGU019	83 681	123 914	
		Total		83 681	123 914	
2	Demand	Scheme Name	Subscheme No	Demand 2020	Demand 2050	
		Vulamehlo Cross Border Scheme	UGU019	14.44	22.33	
		Total		14.44	22.33	
3	Water Resource	Source	HFY (Mm³/a)	HFY (Mℓ/day)	Comments	
		Mtwalume River Weir and Proposed Vulamehlo Dam	-	-	Water will be sourced from the Mtwalume River Weir and Proposed Vulamehlo Dam	
4	Infrastructure		WTP Name	Class	Scheme Number	Capacity (Mℓ/day or Length or kW)
4.1	Existing	WTP	VULAMEHLO WTP	Internal Bulk	UGU019	4.5
		Bulk Pipelines	uPVC, Steel, HDPE, AC	Primary Bulk	>350	13.26
				Secondary Bulk	160 ø mm - 300 ømm	0.00
				Tertiary Bulk	50 ø mm - 110 ømm	224.70
		Pump stations	Pennington WPS	Regional Bulk	UGU019	0
			Shayamoya WPS	Regional Bulk	UGU019	0
		Reservoirs	Braemer Reservoir/Water plant	Secondary Bulk	1	0.25
			Mahlathini Reservoir	Secondary Bulk	0	0.00
			Unknown	Secondary Bulk	0	0.00
			Unknown	Secondary Bulk	0	0.00
			Unknown	Secondary Bulk	0	0.00
			Unknown	Secondary Bulk	0	0.00
			Unknown	Secondary Bulk	0	0.00
JOLIVET RES B2	Secondary Bulk		1	50.00		
JOLIVET BPT B2.1	Secondary Bulk	0	0.00			

4.2	Future	WTP	VULAMEHLO WTP (Upgrade)	Internal Bulk	-	5.5
		Bulk Pipelines	uPVC, Steel, HDPE, AC	Primary Bulk	>350	56.86
				Secondary Bulk	160 ø mm - 300 ømm	6.45
				Tertiary Bulk	50 ø mm - 110 ømm	0.83
		Reservoirs	Reservoir	Secondary Bulk	1	11000
			Reservoir	Secondary Bulk	1	4000
			Reservoir	Secondary Bulk	1	2500
			Reservoir	Secondary Bulk	1	2000
			Reservoir	Secondary Bulk	1	1500
			Reservoir	Secondary Bulk	3	1000
			Reservoir	Secondary Bulk	1	600
			Reservoir	Secondary Bulk	3	500
			Reservoir	Secondary Bulk	1	300
			Reservoir	Secondary Bulk	1	200
Pump stations	Primary PS	Primary Bulk	-	277		
	Secondary PS	Secondary Bulk	-	147		
5	Cost Requirement		Capital Cost	10% Contingencies	Total Cost (Excl VAT)	
		Primary Bulk	R915 479 269.49	R91 547 926.95	R1 007 027 196.44	
		Secondary Bulk	R199 328 659.08	R19 932 865.91	R219 261 524.98	
		Tertiary Bulk	R53 219 704.65	R5 321 970.46	R58 541 675.11	
		Total	R1 168 027 633.21	R116 802 763.32	R1 284 830 396.53	

UG013 WSIA: KwaMbotho Scheme

The total bulk cost requirement for the KwaMbotho Scheme is R84 133 924.04 (excl VAT). The scheme development cost per household is approximately R 13 000.

Kwa-Mbotho Scheme						
Item	Description					
1	Population	Scheme Name	Subscheme No	Population 2020	Population 2050	
		Kwa-Mbotho Scheme	UGU006	16 116	25 887	
		Total		16 116	25 887	
2	Demand	Scheme Name	Subscheme No	Demand 2020	Demand 2050	
		Kwa-Mbotho Scheme	UGU006	2.84	4.77	
		Total		2.84	4.77	
3	Water Resource	Source	HFY (Mm3/a)	HFY (Mℓ/day)	Comments	
		Ncekete River	-	-	Water is sourced from the Ncekete River	
4	Infrastructure	WTP Name	Class	Scheme Number	Capacity (Mℓ/day or Length or kW)	
4.1	Existing	WTP	KWAMBOTHO WTP	Internal Bulk	UGU006	0
		Bulk Pipelines	uPVC, Steel, HDPE, AC	Primary Bulk	>350	0.00
				Secondary Bulk	160 ø mm - 300 ømm	0.00
				Tertiary Bulk	50 ø mm - 110 ømm	14.45
				Pump stations	Pungashe RES 1 WPS	Regional Bulk
			Phungashe 2 WPS	Regional Bulk	UGU006	0
		Reservoirs	Santomba Reservoir (G)		0	0.00
			Isitebele Reservoir (Kwambotho)	Secondary Bulk	1	0.12
			Kwanonkala Reservoir (Kwambotho)	Secondary Bulk	1	0.20
			Kwambotho Reservoir	Secondary Bulk	1	0.12
Kwanyuswa Reservoir			0	0.00		
4.2	Future	Bulk Pipelines	uPVC, Steel, HDPE, AC	Primary Bulk	>350	0
				Secondary Bulk	160 ø mm - 300 ømm	18.4
				Tertiary Bulk	50 ø mm - 110 ømm	13.24
		Reservoirs	Reservoir	Secondary Bulk	1	5000
			Reservoir	Secondary Bulk	1	1500
			Reservoir	Secondary Bulk	1	1000
			Reservoir	Secondary Bulk	1	700
			Reservoir	Secondary Bulk	1	600

		Reservoir	Secondary Bulk	1	400
		Reservoir	Secondary Bulk	1	250
		Reservoir	Secondary Bulk	0	3500
		Reservoir	Secondary Bulk	0	2500
		Reservoir	Secondary Bulk	0	2100
		Reservoir	Secondary Bulk	0	2000
		Reservoir	Secondary Bulk	0	0
		Reservoir	Secondary Bulk	0	0
		Reservoir	Secondary Bulk	0	0
		Reservoir	Secondary Bulk	0	0
		Reservoir	Secondary Bulk	0	650
		Reservoir	Secondary Bulk	0	550
		Reservoir	Secondary Bulk	0	500
		Reservoir	Secondary Bulk	0	450
		Reservoir	Secondary Bulk	0	0
		Reservoir	Secondary Bulk	0	200
		Pump stations	-	-	-
5	Cost Requirement	Capital Cost	10% Contingencies	Total Cost (Excl VAT)	
		Primary Bulk	R0.00	R0.00	R0.00
		Secondary Bulk	R60 009 428.16	R6 000 942.82	R66 010 370.98
		Tertiary Bulk	R16 475 957.33	R1 647 595.73	R18 123 553.06
		Total	R76 485 385.49	R7 648 538.55	R84 133 924.04

UG014 WSIA: KwaNyuswa Scheme

The total bulk cost requirement for the KwaNyuswa Scheme is R74 360 081.79 (excl VAT). The scheme development cost per household is approximately R 16 600.

KwaNyuswa Scheme						
Item	Description					
1	Population	Scheme Name	Subscheme No	Population 2020	Population 2050	
		KwaNyuswa Scheme	UGU004	11 143	17 899	
		Total		11 143	17 899	
2	Demand	Scheme Name	Subscheme No	Demand 2020	Demand 2050	
		KwaNyuswa Scheme	UGU004	1.93	3.24	
		Total		1.93	3.24	
3	Water Resource	Source	HFY (Mm ³ /a)	HFY (Mℓ/day)	Comments	
		KwaNyuswa River	-	-	Water is sourced from the KwaNyuswa River	
4	Infrastructure		WTP Name	Class	Scheme Number	Capacity (Mℓ/day or Length or kW)
4.1	Existing	WTP	KWA NYUSWA WTP 1	Regional Bulk	UGU004	0.25
		Bulk Pipelines	uPVC, Steel, HDPE, AC	Primary Bulk	>350	5.79
				Secondary Bulk	160 ø mm - 300 ømm	0.00
				Tertiary Bulk	50 ø mm - 110 ømm	0.00
				Pump stations	St Helens Rock WPS	Regional Bulk
		Reservoirs	Kwanyuswa Reservoir (A)	Regional Bulk	UGU004	0
				Secondary Bulk	1	0.40
		Reservoirs	Kwanyuswa Reservoir (B)	Secondary Bulk	1	0.60
Future	Bulk Pipelines			uPVC, Steel, HDPE, AC	Primary Bulk	>350
		Secondary Bulk	160 ø mm - 300 ømm		20.66	
		Tertiary Bulk	50 ø mm - 110 ømm		9.86	
	Reservoirs	Reservoir	Secondary Bulk	1	1200	
		Reservoir	Secondary Bulk	1	500	
		Reservoir	Secondary Bulk	3	400	
		Reservoir	Secondary Bulk	1	300	
Reservoir		Secondary Bulk	1	120		
Reservoir	Secondary Bulk	1	100			
Pump stations	-	-	-	-		
5	Cost Requirement		Capital Cost	10% Contingencies	Total Cost (Excl VAT)	

	Primary Bulk	R0.00	R0.00	R0.00
	Secondary Bulk	R46 634 124.29	R4 663 412.43	R51 297 536.72
	Tertiary Bulk	R20 965 950.07	R2 096 595.01	R23 062 545.07
	Total	R67 600 074.36	R6 760 007.44	R74 360 081.79

UG015 WSIA: KwaNdelu Scheme

The total bulk cost requirement for the KwaNdelu Scheme is R49 906 459.15 (excl VAT). The scheme development cost per household is approximately R 8 400.

KwaNdelu Scheme						
Item	Description					
1	Population	Scheme Name	Subscheme No	Population 2020	Population 2050	
		KwaNdelu Scheme	UGU016	14 907	23 946	
		Total		14 907	23 946	
2	Demand	Scheme Name	Subscheme No	Demand 2020	Demand 2050	
		KwaNdelu Scheme	UGU016	2.50	4.19	
		Total		2.50	4.19	
3	Water Resource	Source	HFY (Mm3/a)	HFY (Mℓ/day)	Comments	
		Ndelu River	1.606	4.4	Water is sourced from the Ndelu River	
4	Infrastructure	WTP Name	Class	Scheme Number	Capacity (Mℓ/day or Length or kW)	
4.1	Existing	WTP	KWANDELU WTP	Internal Bulk	UGU016	1.4
		Bulk Pipelines	uPVC, Steel, HDPE, AC	Primary Bulk	>350	17.49
				Secondary Bulk	160 ø mm - 300 ømm	0.00
				Tertiary Bulk	50 ø mm - 110 ømm	10.40
				Pump stations	Nkuku WPS	Regional Bulk
		Pump stations	Odeke WPS	Regional Bulk	UGU016	0
			Ndelu WPS	Regional Bulk	UGU016	0
		Reservoirs	Unknown		0	0.00
4.2	Future	Bulk Pipelines	uPVC, Steel, HDPE, AC	Primary Bulk	>350	0
				Secondary Bulk	160 ø mm - 300 ømm	14.77
				Tertiary Bulk	50 ø mm - 110 ømm	22.79
		Reservoirs	Reservoir	Secondary Bulk	1	600
			Reservoir	Secondary Bulk	1	500
			Reservoir	Secondary Bulk	1	200
			Reservoir	Secondary Bulk	2	150
			Reservoir	Secondary Bulk	1	100
Pump stations	-	-	-	-		
5	Cost Requirement		Capital Cost	10% Contingencies	Total Cost (Excl VAT)	
		Primary Bulk	R0.00	R0.00	R0.00	
		Secondary Bulk	R28 189 697.29	R2 818 969.73	R31 008 667.02	

		Tertiary Bulk	R17 179 811.03	R1 717 981.10	R18 897 792.13	
		Total	R45 369 508.32	R4 536 950.83	R49 906 459.15	